



2015 Owner's Manual

21 CC



23 CC



Specifications subject to change without notice. Actual boats may vary from drawings and/or photos.
Copyright 2012 Pro-Line Boats Inc., PO Box 457, Washington, NC 27889
All rights reserved. June 3, 2014

Table of Contents

	Page
Introduction	
Specifications.....	1
Owner’s Package	2
Dealer Responsibilities	2
Customer Responsibilities	2
Capacity.....	3
Insurance and Registration	3
Warranty.....	3
Safety	
Carbon Monoxide	6
Emergency Treatment for CO Poisoning.....	6
Where CO May Accumulate	7
How To Protect Others and Yourself	7
Fire.....	8
Equipment.....	8
Flooding.....	8
Hazardous Conditions.....	8
Passenger Safety	9
Regulations.....	9
Rules of the Road.....	9
Alcohol.....	9
Controls	
Throttle and Shift Controls.....	10
Ignition – Binnacle, Fwd, Neutral and Reverse Gear Operation	10
Key Switch Alarm.....	10
Lanyard Stop Switch	10
Shift / Throttle / Trim	11
Steering	11
Mechanical – No Feedback	11
Hydraulic Steering (Optional).....	11
Power Trim.....	11
Steering Wheel	11
Systems and Accessories	
Electrical System	12
Circuit Breakers.....	12
Switch and Breaker Panel.....	12
Lighting Systems	13
Navigation and Anchor Lights	13
Instrumentation.....	13
Compass (Optional).....	13
Horn - Electric.....	13
Gauges (Analog)	13
Sea Water System	14
Baitwell	14
Bilge Pump.....	15
Casting Deck with Storage.....	15
Fish Boxes.....	15

	Page
Fuel/Oil Systems.....	15
Fuel Fill Fitting.....	15
Fuel Sender and Fuel Pick Up.....	15
Fuel Tank.....	16
Fuel Water Separator.....	16
Primer Bulb.....	16
Oil Tank and Fill.....	17
Fuel / Oil Leaks.....	17
Windows, Storage, Hatches and Latches.....	17
Windshield.....	17
Hatches and Latches.....	17
Storage.....	17
Hardware.....	17
Cleats.....	17
Hand Rails.....	18
Gunwale Trim / Rubrail.....	18
Thru Hull Fittings.....	18
Drain Plug.....	18
Cockpit / Deck Drains.....	18
Half Dive Platform with Ladder.....	18
Bimini Top.....	18
Canvas T-Top (Optional).....	18
Seating.....	19
Vinyl Upholstery.....	19

Operation and Performance

Trim / Tilt.....	20
Propellers.....	21
Starting.....	21
Before Starting the Engines.....	21
Starting the Engines.....	21
After Starting the Engines.....	21
Fueling.....	22
Before Fueling.....	22
While Fueling.....	22
After Fueling.....	22
Loading.....	22

Trailer and Launching

Selecting a Trailer.....	23
Check Before You Go Out On The Highway.....	23
Backing a Trailer.....	24
Pre-Launching Preparations.....	24
Launching.....	25
Retrieval.....	25
Storage.....	25

Service and Care	Page
Fiberglass and Gelcoat.....	26
Epoxy Barrier Coat and Bottom Paint.....	26
Graphics	27
Gunwale Trim/Rubrail	27
Baitwell Pump	27
Fuel Water Separator	27
Compass	27
Aluminum	28
Stainless Steel.....	28
Windshield	29
Bimini Top and T-Top Canvas.....	29
Canvas	29
Vinyl	30
Exterior Vinyl – Upholstered Seats and/or Cushions.....	30
Corrosion Protection.....	30
Winterizing and Storage	30
Resealing	31
Additional Cleaning and Maintenance Products.....	31
Appendix	
Helpful Check Lists.....	32
Each Time You Go On A Boat Trip	32
Once A Month	32
Once A Year	32
Trouble Shooting Chart.....	33
Boat Identification Information.....	34

While we endeavor to be as accurate as possible, certain changes in standard equipment, options and the like may have occurred which would not be included in the Owner's Manual. All weights and fuel capacities are estimates and could/will vary with each vessel and with each application. In all cases, consult your local Pro-Line dealer for the most current information.

Introduction

Congratulations on the purchase of your new Pro-Line Boats Classic Series sport fishing boat. Welcome into the proud family of satisfied Pro-Line owners. Every expedition lets you enjoy the outstanding features designed into every boat we construct. Your new Pro-Line is more than just a boat, it's a whole new lifestyle.

Pro-Line's commitment to the needs and wishes of the sport fishing family has resulted in a superior fishing craft providing you with comfort, performance, security, and outstanding fishability. All of our boats comply with U.S. Coast Guard (USCG) safety regulations and are designed and crafted in accordance with the National Marine Manufacturers Association (NMMA), the American Boat and Yacht Council (ABYC) standards, and the Common European directive (CE).

This manual (to be kept onboard your Pro-Line) is designed to provide you with information necessary for the safe, efficient operation and care of your new Pro-Line. Take the time now to carefully review the owner's manual and the additional information in your owner's package to maximize your enjoyment and safety as well as familiarize yourself with your new boat.

We have prepared this manual to help you fully enjoy each voyage while operating your boat safely. While the information in the manual cannot and does not cover every boating situation, we urge you to read this manual carefully and familiarize yourself with the boat before using it. If a specific method or procedure is not recommended, you must make sure that whatever action you take is safe for you, your passengers and others on the water. Always use common sense when boating.

Specifications

21 cc

Length Overall (LOA)	21' 8"	Cockpit Area	86 sq. ft.
Beam	8' 5"	Cockpit Depth	25"
Draft (Hull)	17"	Bridge Clearance	
Deadrise	20 degrees	to Top of Windshield	5' 10"
Fuel Capacity	70 gal	w/ T-Top	8' 0"
Weight		Maximum Horsepower	150 hp
Hull – w/o Engines	2,700 lbs.	Baitwell Capacity	15 gal
Trailerable	3,800 lbs.	Fishbox Capacity	18 gal

23 cc

Length Overall (LOA)	23' 0"	Cockpit Area	81 sq. ft.
Beam	8' 6"	Cockpit Depth	22"
Draft (Hull)	15"	Bridge Clearance	
Deadrise	19 degrees	to Top of Windshield	5' 10"
Fuel Capacity	70 gal	w/ T-Top	8' 0"
Weight		Maximum Horsepower	200 hp
Hull – w/o Engines	3,200 lbs.	Baitwell Capacity	15 gal
Trailerable	TBD	Fishbox Capacity	18 gal

Owner's Package

Each Pro-Line boat comes with an Owner's Package that contains this Owner's Manual along with materials supplied by various manufacturers whose products have been installed on your boat. Manufacturers of certain products (i.e., Stereo, TV, Stove, Refrigerator, Microwave, Engines, Electronics, etc.) provide their own limited warranty and owner's manuals. While we have endeavored to be as accurate as possible in this manual, if you should notice a discrepancy between the information in this manual and that of the individual supplier's manual, *always follow the instructions in the supplier's manual.*

Make sure that you complete the individual warranty cards for these products and forward them on to the respective manufacturers to register for your warranty with them. Retain all materials in your Pro-Line Owner's Package for easy reference.

Dealer Responsibilities

Your dealer's responsibilities include but are not limited to:

- Pre-delivery verification of proper rigging and operation. Deliver the boat in water ready condition unless you and your dealer have agreed upon other arrangements.
- Complete the pre-delivery checklist with the customer at the time of delivery.
- Provide adequate orientation in the general operation of your Pro-Line including an explanation of the specific safety considerations regarding the use of the systems and components.
- Provide an explanation of the owner's package and literature, including the warranty registration cards for the vessel, engines and all of the separately warranted equipment and accessories.
- Discuss the terms of all warranties and emphasize the importance of registering each warranty with the specific manufacturers.
- Repair any damages that may have occurred to the boat while the boat has been in the dealer's possession.
- Provide service to Pro-Line boat owners within the locality of the dealership.
- Explain local and out of area service procedures during and after the warranty periods.

Customer Responsibilities

- Review and sign the Pre-Delivery Inspection (PDI) report for the boat and motors with your dealer to ensure that your boat is in top condition when you take delivery.
- Examine the boat at time of delivery to insure that all systems and components are functioning safely and properly. Report any outstanding issues (i.e., scratches, missing items, etc.) to your dealer before or during the delivery of the boat.
- Read all literature and instructions to ensure proper usage and operation of the equipment as well as how to use and maintain all equipment as directed.
- Read and understand the limited warranty. Sign the warranty registration card and mail it to Pro-Line Boats.
- Contact your local Pro-Line dealer for assistance with any warrantable repairs.
- Transportation of your boat to and from your dealer or repair facility for warrantable repairs.
- Schedule your 20-hour boat and engine check up with your dealer.
- Know your boat and the rules of the road before you use your boat.
- **Be proficient in boat handling and safety. This manual is not intended to provide complete training on all aspects of general boat operations. We at Pro-Line urge all boat owners and operators to attend a boating safety course before operating a boat.**

Capacity Information

In accordance with the National Marine Manufacturers Association (NMMA) and the American Boat and Yacht Council (ABYC), all boats 26 feet in length or less are required to display a capacity plate. Your boat is rated for the following capacities.

	Maximum capacity of persons may not exceed:	The combined weight of those passengers may not exceed a total combined weight of:	Total weight including passengers, motor and gear may not exceed:	Maximum horsepower is not to exceed:
21 cc	7 passengers	1,000 pounds	1,700 pounds	150 hp
23 cc	7 passengers	1,200 pounds	1,700 pounds	200 hp

These capacity standards are based on Standards and Recommended Practices for Small Craft published by the National Marine Manufacturers Association (NMMA).

Insurance and Registration

As the owner of the boat, you are legally responsible for all liabilities of operation. Secure **insurance protection** with a reputable insurance company through your local insurance agent.

Learn about and operate your boat in accordance with local, state, and federal laws, regulations, and **registration** requirements.

Warranty

The Pro-Line Boats Limited Warranty is attached to the warranty card. After signing the warranty card, your dealer will provide you with your copy of the warranty and mail the warranty card to Pro-Line Boats, Inc. A copy of the Pro-Line Boats Limited Warranty is also included in this chapter.

The Pro-Line Boats Limited Warranty extends only to parts that were factory installed. Dealer installed items are the responsibility of the dealer. All warrantable repairs are to be completed by an authorized Pro-Line dealer. Your dealer should be able to assist you with any service or warranty related issues.

If for any reason you are dissatisfied with the services performed by your dealer, we suggest that you discuss the matter with the service manager. The service manager is responsible for the quality of service being performed and has a direct interest in resolving your issues to your satisfaction. If the matter is complicated and cannot be resolved to your satisfaction by the service manager, we suggest that you talk to the general manager or owner. In most cases a compromise can be reached.

If the matter cannot be resolved by the dealership to your satisfaction, contact the Pro-Line Boats Customer Service Department by calling 352-795-4111 or by writing to:

Pro-Line Boats, Customer Service Dept., PO Box 457, Washington, NC 27889
FAX: 252-974-7704

So that your dealer and we can provide you with the best possible service, please have the following information available when calling or writing:

- HIN (Hull Identification Number)
- Selling dealer's name and location
- Servicing dealer (if different from selling dealer)
- Nature of problem
- Names of dealership personnel involved with the situation
- Record of service performed and approximate dates

When contacting Pro-Line Boats, please keep in mind that your issue will most likely be resolved at the dealership, using their facilities, equipment, personnel and/or sublet repair facilities.

Note: There are items that are **not covered** by the Pro-Line Boats Limited Warranty, including but not limited to the following:

- All non-structural hull defects or failures.
- Failure or damage that is a result of normal wear and tear, racing, rental, charter or military use; abuse, negligence, vandalism, lack of maintenance, casualty loss or docking damage.
- Alterations and modifications made without the written authorization of Pro-Line Boats.
- Blistering, fading, chalking, crazing or crazing or cracking of any fiberglass, gelcoat, varnish, paint or metallic finish.
- Statements and representations that estimate the speed, weight, fuel consumption or other performance characteristics of the vessel and any statements, representations or warranties, other than those given in the Pro-Line Classic Series Limited Warranty.

The Ten Year Limited Hull Structural Warranty is transferable to subsequent owners for a nominal fee. Please contact your dealer or Pro-Line Boats to obtain the applicable transfer form so that the new owner will have piece of mind knowing that their pre-owned boat comes with the same structural hull warranty protection that was afforded to the original owner.

PRO-LINE BOATS, LLC LIMITED WARRANTY – 2015 MODEL YEAR

Ten Year Limited Hull Warranty. Pro-Line warrants to the original retail purchaser who purchases from an authorized Pro-Line dealer, ("Purchaser") that for ten (10) years after the date of delivery to its original retail purchaser, each new fiberglass hull manufactured by Pro-Line shall be free from structural defects due to material or workmanship under normal non-commercial use. Hull structural defects are defined as the separation or delamination of the stringers or delamination of the one-piece fiberglass shell below the hull and deck flange.

One Year Limited Components Warranty. Pro-Line warrants to Purchaser that for one (1) year after the date of delivery to its original retail purchaser who purchases from an authorized Pro-Line dealer, all boat components manufactured by Pro-Line shall be free from defects due to material or workmanship under normal non-commercial use.

EXCLUSIONS: This limited warranty does not cover or extend to any of the following:

- (a) Hull or component failure and , or, defects that are a result of normal wear and tear, climatic conditions, commercial use, racing, rental, charter or military use; abuse, misuse, negligence, overloading, modification, vandalism, lack of proper maintenance, accident , fire or other casualty loss or docking damage
- (b) Alterations and modifications without first obtaining the written authorization of Pro-Line shall be excluded from coverage as it relates to the alterations/modifications
- (c) Window breakage and leaks in windows and hatches after the first year
- (d) Components manufactured by another manufacturer (including, but not limited to, engines, transmissions, propellers, generators, electronics, batteries, air conditioning units and appliances) and components not originally installed by Pro-Line. Warranties provided to Pro-Line by component manufacturers will be passed on to purchaser as allowed by the component manufacturer. Pro-Line's dealer will identify the authorized service dealer for any such components manufacturers upon request.
- (e) Tears, fading, discoloration or mildewing of curtains, cushions, tops, headliners or other fabric or upholstered components
- (f) Blistering, fading, chalking or cracking of any gel-coat, varnish, paint or metallic finish
- (g) Electrolysis, galvanic corrosion, crevice corrosion or any other deterioration of underwater components
- (h) Statements, advertising or representations that estimate the speed, weight, fuel consumption, static or dynamic attitude in the water, or other performance characteristics of the vessel and any statements, representations or warranties, other than those given in this limited warranty.
- (i) Cost of removal or reinstallation of any component (including components manufactured by Pro-Line or disassembly and reassembly of the unit containing the component
- (j) Components repaired or replaced unless repaired or replaced in accordance with this warranty

Limitations. THE REPAIR OR REPLACEMENT OF DEFECTIVE PARTS SHALL BE THE PURCHASER'S SOLE AND EXCLUSIVE REMEDY AND PRO-LINE'S SOLE AND EXCLUSIVE LIABILITY UNDER THIS WARRANTY. Pro-Line's obligation under this warranty is limited to the repair or replacement (at Pro-Line's sole election) of any covered item found to be defective, when delivered by Purchaser pursuant to written authorization and instructions from Pro-Line, round-trip transportation prepaid, to Pro-Line's manufacturing plant or other designated repair facility. Repaired or replaced items are warranted as provided herein for the unexpired portion of the applicable warranty period.

ANY ORAL STATEMENT OR PRINTED ADVERTISING REGARDING ANY PERFORMANCE CHARACTERISTIC OF THE BOAT OR ITS COMPONENTS SHALL BE CONSIDERED AN ESTIMATE ONLY AND SHALL NOT BE RELIED UPON AS EXPRESS WARRANTY OR AS A BASIS OF THE BARGAIN FOR THE BOAT OR ITS COMPONENTS

THIS WARRANTY, AND THE RIGHTS AND REMEDIES UNDER IT, IS EXCLUSIVE AND IS GIVEN IN PLACE OF ALL OTHER WARRANTIES, WHETHER EXPRESSED OR IMPLIED, INCLUDING ANY IMPLIED WARRANTY OF MERCHANTABILITY OR FITNESS FOR PARTICULAR PURPOSE, WHETHER ARISING BY LAW, CUSTOM, CONDUCT, OR USAGE OF TRADE. PURCHASER'S REMEDIES SHALL BE LIMITED AS STATED HERE-IN AND PRO-LINE SHALL NOT BE LIABLE FOR ANY INCIDENTAL, CONSEQUENTIAL, OR INDIRECT DAMAGES OR LOSSES RESULTING FROM DEFECTS.

THIS LIMITED WARRANTY GIVES PURCHASER SPECIFIC LEGAL RIGHTS. PURCHASER MAY HAVE OTHER RIGHTS WHICH MAY VARY FROM STATE TO STATE. IN THE EVENT THAT IMPLIED WARRANTIES ARE FOUND TO EXIST UNDER THE LAW OF A PARTICULAR STATE NOTWITHSTANDING THE EXCLUSION CONTAINED HEREIN, THE DURATION OF ANY SUCH WARRANTY SHALL BE LIMITED TO THE DURATION OF THE APPLICABLE LIMITED WARRANTY STATED HEREIN.

THE SELLING DEALER IS NOT AN AGENT OF PRO-LINE OR A CO-WARRANTOR AND IS NOT AUTHORIZED BY PRO-LINE TO AMEND OR MODIFY THIS LIMITED WARRANTY IN ANY MANNER.

Pre-delivery Examination. Purchaser represents to Pro-Line that Purchaser has examined the boat and all of its component parts, accessories and equipment to Purchaser's full satisfaction prior to accepting delivery of the boat from the Dealer, or in the alternative, has been given full opportunity to do so and has declined.

Transferability of Warranty. This Limited Hull Structural Warranty may be transferred to subsequent purchasers of the boat during the warranty period, provided that such subsequent purchaser completes a warranty transfer form and sends it and Fifty Dollar (\$50.00) transfer fee to Pro-Line within (30) thirty days of such purchase.

Miscellaneous. Pro-Line Boats, LLC reserves the right to make changes in the design and construction of its products at any time, without notice and without any obligation to incorporate such changes into products of prior manufacture. This limited warranty applies to new boats manufactured by Pro-Line and sold by an authorized Pro-Line dealer, except as such limited warranty may be transferred to a subsequent purchaser as provided herein. The term "new boats" shall include boats that may have been repaired during the manufacturing process as part of Pro-Line's quality assurance program. This limited warranty contains the entire agreement between both Pro-Line and Purchaser and supercedes all other prior agreements, discussions, negotiations, commitments, and representations, whether oral or written, between them regarding Pro-Line's warranty. If any provision of this limited warranty, or the application of it, is determined to be invalid or unenforceable for any reason, the remainder of this limited warranty and the application of it shall not be affected.

All communications and notices from Purchaser regarding this limited warranty should be sent to: PRO-LINE BOATS, LLC, Customer Service Dept., P.O. Box 457, Washington, North Carolina 27889. Telephone: (252)-975.2000

Acknowledgement of Limited Warranty. By signing the accompanying product registration card, Purchaser, (or each Purchaser, if more than one) agrees that he or she has read a copy of this limited warranty in its entirety and understands its terms and conditions. Purchaser (or each of them) acknowledges receipt of a copy of this limited warranty at the time of sale.

Safety

Your Pro-Line boat has been constructed with safety in mind. But, remember, boating safety and the safety of your passengers is YOUR ultimate responsibility. You should fully understand the operations of your vessel as well as the basics in boating safety.

Your local U.S. Coast Guard Auxiliary (USCGA) and the U.S. Power Squadrons (USPS) offer excellent safe boating classes several times a year. If you have not already passed a boating safety course, we recommend that you do so at your earliest convenience.

Plan your trips carefully. Insure ample fuel supply and a reserve. Tell someone where you are going and when you expect to return. Keep current charts onboard. Read USCG boating safety circulars and follow the safety guidelines.

Carbon Monoxide

Be aware of and avoid conditions that can cause Carbon Monoxide poisoning (see USCG boating safety circular 77). Sources of Carbon Monoxide (CO) include any gas or diesel engine and any flame from items such as a charcoal grill, stove or heater. Carbon Monoxide can accumulate to deadly levels in enclosed spaces. Always ventilate occupied areas of the vessel with fresh clean air.

In high concentrations, CO can be fatal within minutes. The effects of CO in lower concentrations are cumulative and can be just as lethal over long periods of time. CO poisoning is often confused with seasickness. So be aware of the following CO symptoms: Itchy and watery eyes, flushed appearance, throbbing temples, inability to think coherently, ringing in the ears, tightness across the chest, headaches, drowsiness, nausea, dizziness, fatigue, vomiting, collapse and convulsions.

Do not stand or swim near the motor when the engine is idling.

Carbon monoxide can harm and even kill you inside or outside your boat!

Did you also know:

- CO symptoms are similar to seasickness or alcohol intoxication?
- CO can affect you whether you're underway, moored or anchored?
- You cannot see, smell or taste CO?
- CO can make you sick in seconds? In high enough concentrations, even a few breaths can be fatal.

Most important of all, did you know CO poisonings are **preventable**? Every boater should be aware of the risks associated with CO - what it is; where it may accumulate; and the symptoms of CO poisoning. To protect yourself, your passengers and those around you, learn all you can about CO.

Emergency Treatment for CO Poisoning

CO poisoning or toxicity is a life-threatening emergency that requires immediate action. The following is a list of things that should be done if CO poisoning is suspected. Proceed with caution. The victim may be in an area of high CO concentration, which means you or others could also be in danger from exposure to CO.

- Evaluate the situation and ventilate the area, if possible.
- Evacuate the area and move affected person(s) to a fresh air environment.
- Observe the victim(s).
- Administer oxygen, if available.
- Contact medical help. If the victim is not breathing, perform rescue breathing or approved cardiopulmonary resuscitation (CPR), as appropriate, until medical help arrives. Prompt action can mean the difference between life and death.
- Shut off potential sources of CO, if possible. Correct ventilation problems and/or repair exhaust problems as appropriate. Investigate the source of CO and take corrective action, such as evacuating and ventilating the area, or shutting off the source of the CO while at the same time evacuating and ventilating the area.

Where CO May Accumulate - Carbon Monoxide can accumulate anywhere in or around your boat as shown in the following pictures:



Inadequately ventilated canvas enclosures.



Exhaust gas trapped in enclosed places.



Blocked exhaust outlets.



Another vessel's exhaust. CO from the boat docked next to you can be just as deadly.



"Station wagon effect" or back drafting.

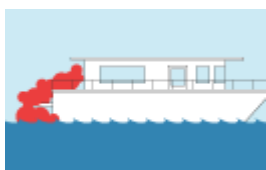

At slow speeds, while idling, or stopped. Be aware that CO can remain in or around your boat at dangerous levels, even if your engine or the other boat's engine is no longer running!

How to Protect Others and Yourself

You are in command of your boating safety. Follow these simple steps to help keep Carbon Monoxide from poisoning you, your passengers or others around you.

- Know where and how CO may accumulate in and around your boat.
- Maintain fresh air circulation throughout the boat at all times. Run exhaust blowers whenever the generator is operating.
- Know where your engine and generator exhaust outlets are located and keep everyone away from these areas.
- Never sit, teak surf or hang on the back deck or swim platform while the engines are running. (Teak Surfing is a new and dangerous boating fad that involves an individual holding on to the "teak" swim platform of a vessel while a wake builds up then lets go to body surf on the wave created by the boat; hence the term - Teak Surfing.) Teak surfing is never a safe activity.
- Never enter areas under swim platforms where exhaust outlets are located unless the area has been properly ventilated.
- Although CO can be present without the smell of exhaust fumes, if you smell exhaust fumes, CO is also present. Take immediate action to dissipate these fumes.
- Treat symptoms of seasickness as possible CO poisoning. Get the person into fresh air immediately. Seek medical attention unless you are sure it is not CO.
- Install and maintain CO alarms inside your boat. Do not ignore any alarm. Replace alarms as recommended by the alarm manufacturer.
- Get a Vessel Safety Check. A VSC is a free bow-to-stern safety examination.

Fire

- Be aware of and avoid conditions that can lead to accidental fire.
- Guard against and watch for fuel spills and leaks.
- Inspect wiring for damage or exposure that could lead to short circuits or arcing.
- Make sure those who smoke are careful to avoid accidental fire ignition.
- Do not allow smoking while fueling.
- Keep a USCG approved fire extinguisher on board at all times.
- Inspect the fire extinguisher regularly, learn how to use it properly and instruct others as well.
- Use water to fight a fire as a last resort after making arrangements to abandon the boat if a fire should get out of control.
- Keep the following in mind if a fire is burning out of control and you must abandon the boat:
 - Abandon the boat into the wind to minimize burn risk from floating fuel.
 - Wear a PFD unless you must swim under burning fuel.
 - If swimming under burning fuel, throw a PFD outside of the burning area and swim under the burning fuel to it.

Equipment

USCG regulations require that you have the following Coast Guard approved equipment onboard while operating your boat:

- Fire extinguisher(s)
- Personal Flotation Device (PFD) for each occupant
- One throwable PFD
- Sound signal device
- Navigational lights if operated at night
- Sight signal device approved for day and night use when in coastal waters or the great lakes

In addition, here is a list of suggested equipment you should have aboard your Pro-Line:

- Binoculars
- Bailing device
- 2 way radio
- Navigation device
- Tool kit and lubricant
- Spare fuses and bulbs
- First aid kit and blankets
- Mooring lines and fenders
- Combination oar/boat hook
- Spare prop and hardware
- Local charts and compass
- Emergency food and water
- EPIRB (emergency beacon)
- Waterproof matches or lighter
- Floating key chain and spare keys
- Spare fasteners, hose clamps and plugs
- Waterproof flashlight and spare batteries
- Anchor and sea anchor with sufficient line

Flooding

Be aware of and avoid conditions that can cause your boat to flood with water. Possible causes of flooding include:

- Damage to the hull or thru-hull fitting
- Waves washing into the boat
- Water entering cockpit due to improper loading
- Failure to properly install the drain plug.

The boat will become flooded and may swamp, capsize or sink if water enters the boat faster than the bilge pump can expel it.

Hazardous Conditions

Keep track of weather developments and avoid hazardous conditions whenever possible. When forced to operate your Pro-Line in storm conditions:

- Wear PFD's.
- Stow loose gear and equipment.
- Place heavy items as low as possible.
- Head for the easiest port to reach a safe location.
- Reduce speed. You are moving too fast if the boat leaves the water.
- If power fails, anchor or rig a sea anchor off the bow (an empty ice chest in a pinch).
- Stay with the boat if it capsizes, unless it is burning out of control.

Passenger Safety

You are responsible for the safety and conduct of your passengers. Make sure that:

- You instruct your passengers on the proper use and location of PFD's. Children and non-swimmers should wear one at all times.
- Each passenger is in a safe location when underway and knows to keep the boat balanced.
- At least one other person knows how to operate the boat in case of an emergency.
- Your passengers are aware of propeller dangers and the possibility of sudden maneuvers and jolts.
- The **engine is turned off and the key is removed** when swimmers are near the prop or using the dive platform.
- All passengers keep away from lines under stress in case they break and recoil.

Regulations

The USCG is the authority of all waterways. Local authorities enforce State Boating Regulations. You are subject to marine traffic laws and "Rules of the Road" for both federal and state waterways. Therefore, you must submit to boarding if requested by the proper authority. There are many publications available from the Coast Guard concerning regulations. Call the United States Coast Guard Info Line at (800)-368-5647 for additional information.

Rules of the Road

Know and use the "Rules of the Road". Your boat is subject to U.S. Coast Guard enforced marine traffic laws known as "Rules of the Road." There are two sets of rules: the US Inland Navigation Rules and the International Rules. The latter rules are applicable to all vessels inside the demarcation lines separating inland and international waters. You may obtain a copy of the rules from any of the following and by requesting the publication titled "Navigational Rules, International - Inland."

- Your local USGC
- The United States Coast Guard Info Line (800)-368-5647
- The USCG Headquarters by logging on to uscg.mil

The information here is only a "**brief**" overview. **Please** contact the USCG for detailed information.

- Audible warning signals:
 - One short horn blast: starboard course change.
 - Two short horn blasts: port course change.
 - Three short horn blasts: astern operation.
 - Five horn blasts: doubt about previous signal or danger.
 - A Five-second horn blast every minute: for fog operation.
- When overtaking, give-way vessel announces intention with horn blast(s) and waits for a response, then completes maneuver.
- When approaching head-on, both boats give way after giving appropriate horn blast(s) (preferably to starboard).
- When crossing, a vessel converging from starboard has the right-of-way. Port vessel gives way (both acknowledge with one short horn blast).
- Know and observe navigational buoys and markers.
- Give way to craft under sail.

Alcohol

Don't drink and drive. If you have been drinking, appoint someone who is an experienced boater and has not been drinking to be the designated driver. Never operate a boat under the influence of drugs or alcohol. Operation of motorized vessels while under the influence is a Federal offense carrying a significant penalty.

Controls

Controls and engine systems vary greatly from one engine manufacturer to another. Please read your engine owner's manual carefully.

Note: If your engine package was **not factory installed**, some components that are normally standard installations may not be included.

Throttle and Shift Controls

Ignition – Binnacle, Forward, Neutral and Reverse Gear Operation

The binnacle is located at the console forward of the helm seat. To ensure that the binnacle is working properly, shift the binnacle forward to put the engine in forward gear. Make sure the engine shifts smoothly into idle with no grinding of the gears. Bring the binnacle back into neutral and repeat the same process while going into reverse. Again, ensure that there are no gears grinding. It is important to check the binnacle at wide-open throttle (WOT) to ensure the binnacle is not stiff and operates smoothly while going into the WOT position.

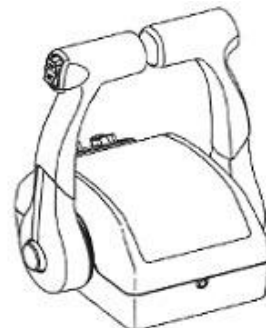

Actual binnacle will vary depending upon the engine package that was selected.

Key Switch Alarm

The key switch alarm is located in the binnacle and sounds when the ignition key is turned on. The key switch alarm is actually a warning alarm that goes off when any overheating problems may occur with the engine. To check the key switch alarm, turn the ignition key to the right but do not start the engine. The alarm will sound ensuring that the engine warning alarm is working properly. When finished, turn the key off.

Lanyard Stop Switch

To ensure the lanyard stop switch (also called the emergency stop feature) on the engine works properly, first turn on the ignition key and start up the engine. While the engine is running, locate the lanyard stop switch. The lanyard stop switch is installed in close proximity to the binnacle or the ignition key. While the engine is running in the neutral position, pull the lanyard stop switch downward until the plastic element at the end of the lanyard pulls the stop switch pin into the off position. This process will automatically stop the engine and will ensure that the emergency lanyard stop switch is working properly.

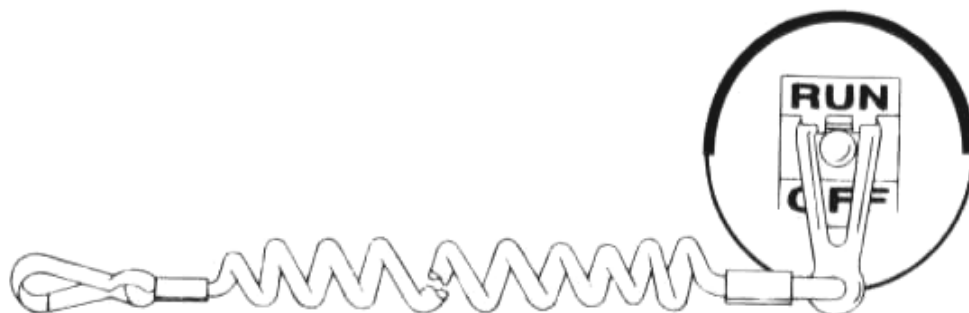

LANYARD STOP SWITCH

Shift / Throttle / Trim

Your vessel can be ordered with different shift/throttle systems based upon motor type. Refer to the owner's packet to find the manual pertaining to your particular installation. Each motor has an individual tilt/trim switch located on the throttle lever. Separate shift and throttle controls are available for each outboard motor.

The throttle lever has three range positions: "Forward", "Neutral", and "Reverse". The shift function occurs in the first portion of the lever travel. After the transmission is shifted into gear, further movement of the lever advances the throttle.

Push the throttle lever ahead to move forward and pull it back for reverse. Centralize the lever to the detent position for neutral. The throttle lever is equipped with a neutral safety switch to prevent the motor from starting in gear. The initial short movement of the lever to engage the transmission should be made firmly to avoid causing gear clash.

CAUTION: Use care in shifting to avoid advancing the throttle more than intended.

Steering

Steering systems will differ depending upon your selection of engine package. Please carefully read the owner's manual provided by the specific manufacturer. Check your particular engine specifications for details specific to your engine package. Always follow the engine manufacturer's recommendations relating to the care and maintenance of their product.

Mechanical – No Feedback

When the steering wheel is turned, the helm pump pumps fluid to the steering cylinder causing it to extend or retract. Periodically, check the fluid level and fill as necessary. Beware of adding too much fluid, especially if the ambient temperature is cold because subsequent expansion could cause leaking or damage to your system. Refer to the owner's manual that was provided by your engine manufacturer.

After every 24 hours of operation check all nuts, caps, and hose fittings for tightness. Make sure the hoses are not chafing or kinking on sharp corners. Also, check that hose ends are not damaged or distorted. The fluid should be changed annually under normal conditions and every six months during times of heavy usage. If your steering does not operate properly, check the following:

- Drive entanglements
- Level of the hydraulic steering fluid (applies with optional Hydraulic steering)
- Hoses and/or fittings for leaks
- Air in the steering system

To properly check the steering system, start by turning the steering wheel port to starboard. If the engine does not respond the same time as the steering wheel is being turned, this means that there is air in the steering system and the steering system needs re-bleeding. When there is air in the steering, the steering wheel will feel "loose". Contact your dealer to have them bleed the steering system.

Hydraulic Steering (Optional)

Check your particular engine specifications for details specific to your engine package. Always follow the engine manufacturer's recommendations relating to the care and maintenance of their product.

Power Trim

The power trim unit is located on the engine and can be operated by using the trim button on the engine or by using the trim toggle switch on the binnacle. To ensure the power trim is working, start by pressing the toggle trim switch in the up position and trim the engine to the full up position. Repeat the same process by pressing the trim toggle switch down and the engine will go into the full down position. See the Trim and Tilt information in the Operations section of this manual.

Steering Wheel

The steering wheel is mounted at the helm along with the binnacle, switch panel and other controls. Please refer to the Care and Maintenance section of this manual for cleaning recommendations.

Systems and Accessories

Electrical System

Circuit Breakers

Circuit breakers and/or fuses protect the wiring. In the event a device stops working, check to see if the circuit breaker is tripped or if the fuse is blown. Breakers are installed in the following locations:

- The main breaker is installed behind the hatch for the starboard battery compartment for all Classic Series models with the exception of the 18 Flats. The main breaker for 18 Flats is installed inside the console.
- The breaker and/or fuse for the aft bilge are located behind the hatch for the starboard battery compartment.
- Additional breaker switches are also located on the switch panel below the individual switches.

A tripped breaker will protrude or move from its set position indicating that the circuit has been overloaded. Turn off the device(s) on the circuit, and then reset the breaker by pushing in once or by returning a breaker switch to the on position. If the breaker does not reset or if it resets and then trips again after the device is turned back on, then a short circuit exists or your device may be damaged, overloaded, or faulty. Correct the problem and then reset the breaker.

If the breaker continues to trip and you are certain the device, switch and wiring are in good repair; either the breaker is faulty or it is too small for the load. Reduce the load or replace the breaker.

Switch and Breaker Panel

The 4 switch panel with circuit breakers is located on the console.

Baitwell Pump - The baitwell pump is located in the bilge area and is plumbed to a seacock (ball valve). For the pump to operate properly you need to make sure the seacock is in the open position. The seacock is wide open when the yellow seacock lever is vertical. When the yellow seacock lever is horizontal, the seacock is closed.

The underside of the seacock thru-hull is equipped with a scoop to allow the water to be picked up even when the boat is on plane. When the boat is not in the water or the baitwell pump is not going to be used for an extended period of time, the seacock valve should be in the closed position. To activate the pump, depress the switch to the up or forward position. To turn the pump off after the baitwell tub is full, depress switch to the down or aft position.

Bilge Pump - Your boat is equipped with an automatic bilge pump and float switch. This pump is located in the bilge and is mounted as far aft as possible. The bilge pump and float switch are accessible via the hatch that is installed in the center of the motor well.

The bilge pump is wired automatic to the battery and has a manual override located at the switch panel on the console. The automatic float switch is wired directly to the **House** battery terminals through breakers or inline fuses. The circuit breaker is located at the helm next to the manual switch. Depressing the bilge pump switch to the up or forward position activates the bilge pump.

Horn - The horn is used to signal, warn, or alert other boats, swimmers or people on shore. Depress the horn switch to the up or forward position to activate the horn. Release the horn switch to deactivate the horn. Using different sequences of horn blasts indicates different and sometimes dangerous situations to you or someone around you. Avoid any horn use without an appropriate purpose. See the Safety Section in this manual and/or take a safe boating course for more information on the proper use of the horn.

Navigation and Anchor Lights - Locate the Navigation light switch on the instrument panel. This is a 3-way switch (forward, middle, back/aft) that functions as follows when you press the switch:

- Forward position - Turns on the bow lights and the anchor light. This position will also activate the red light in your compass.
 - If you have Faria gauges on the dash panel, this function will illuminate the gauge lights.
 - If the gauges were provided by the engine manufacturer (i.e., Mercury, Honda, etc.), this switch will not illuminate the gauge lights. Instead, your gauge lights will be illuminated when the ignition switch is turned on.
- Middle position – All lights are off.
- Back/Aft position – Anchor light is on; the bow lights and gauge lights are off.

Lighting Systems

Navigation and Anchor Lights

The navigation and anchor lights are required to be used for operation at night or under low visibility conditions to indicate your position to other boaters. Visually verify the operation of your navigation and anchor lights and verify that the lights are free from obstructions. You should check your navigation lights monthly during optimum visibility conditions.

- When you are underway in low visibility conditions, you should have the navigation/anchor switch in the up or forward position. This will activate the navigation lights, as well as your Anchor light.
- When you are anchored or in low visibility conditions, you should turn on the Anchor light. Press the Navigation/Anchor switch to the down or aft position to turn on the anchor light.
- The navigation lights consist of a pair of lights that are mounted at the bow of the boat. The red light is installed on the port side and the green light is installed on the starboard side.

The U.S. Coast Guard requires that the anchor light be installed at the highest point on the boat and must be secured in the up position when you are underway. Therefore, this light will be installed as follows based upon the optional top that you may have selected:

- T-Top – Light will be mounted on the center of the T-Top
- Bimini top or no top – Outlet for the removable light will be installed on the forward edge of the motor well.



Instrumentation

Compass (Optional)

The compass is located on the dash on top of the console. To ensure that the compass light is working properly, press the Navigation/Anchor switch in the forward position to turn on the red LED light inside the compass. When finished, turn the Navigation/Anchor switch back to the middle position.

Please refer to the owner's manual provided by the manufacturer of the compass for operational procedures and for information related to the care and maintenance of their product. When in doubt, always defer to the compass manufacturer's instructions and/or recommendations.



Horn - Electric

The horn is used to signal, warn or alert other boats or persons on shore. The horn switch is located on the switch panel. The horn device is located on the starboard side of the console. Depress the horn switch to the up or forward position to activate the horn, and then release the horn switch to deactivate the horn. Using different sequences of horn blasts indicates different and sometimes dangerous situations to you or someone around you.

See the Safety Section in this manual for more information. Avoid any horn use without an appropriate purpose. Additional information regarding audible warning signals should be covered in a safe boating course.

Gauges (Analog)

All gauges are installed on the console but the configuration and specific location of your gauges will vary depending upon the selection of the various optional engine packages. If your engine package includes the standard analog gauges (i.e., Faria), the gauges will light up when the navigation lights are on.

Fuel - The fuel gauge reads the amount of fuel remaining in the tank. To check the fuel gauge, place a known amount of fuel into the fuel fill and fill the tank. Turn the ignition key on and the fuel gauge should read the approximate amount of fuel in the tank.

For example: If the fuel tank holds 40 gallons of fuel and you pumped 10 - 11 gallons of fuel into the tank, the fuel gauge should read approximately $\frac{1}{4}$ of a tank. This ensures that the fuel gauge and the fuel sender are working properly.

If the fuel gauge is not reading correctly, we recommend that you have the fuel sender checked by a qualified professional before considering changing out the gauge. For more information, please refer to the Fuel/Oil Systems section of this manual.

Tachometer - To ensure the tach is working properly, simply turn the ignition key on and start the engine. While the engine is idling, the tach should be reading in the proper RPM range recommended for the engine. Your engine manual will indicate the appropriate RPM range. When you are running at wide-open throttle, the tach should read near the top end of the recommended RPM range.

If the RPM gauge is reading correctly and the engine throttle settings are correct, the tachometer is operating properly. If the tachometer is not reading correctly, refer to the manual provided by the manufacturer of the gauge (included in your owner's package).

Speedometer (Optional) - To ensure that the speedometer (Speedo) is working properly, get the boat on a planing speed and check to see if the gauge is reading at the approximate running speed at which the boat is traveling.

Note: The speed-reading on the Speedo may vary a few mph from the actual speed that the boat is traveling. Either a GPS or a radar gun can check the running speed.

Sea Water System

Baitwell

The baitwell tub is located in the port aft corner of the cockpit. The baitwell switch at the helm controls the baitwell pump.

The baitwell pump and the seacock are mounted in the bilge. Both are easily accessed via the aft bilge hatch.

Raw water for the baitwell tub comes through the seacock, to the pump and then to the baitwell tub.

Baitwell pump is located in the aft bilge area



Seacock is shown in the closed position



Before turning the pump on from the helm, check to be sure that the seacock is open. The seacock is wide open when the yellow seacock lever is vertical. When the yellow seacock lever is horizontal, the seacock is closed. The seacock should remain closed when the pump is not in use.

Note: The round filter attached to the side of the pump should be removed and cleaned often with clean running water.

To operate the baitwell system: Locate the baitwell switch on the console and press the switch to the forward position to turn on the pump. When the baitwell pump is operating, go to the baitwell tub, open the baitwell lid and visually check to see if water is pumping into the tub through the aerator fitting. If water is not entering the baitwell tub, the aerator fitting may not be open. See the photos to the right to make sure that the lever on the aerator fitting is in the open position. To turn the baitwell pump off, press the baitwell switch to the aft position. You should always turn the baitwell switch off at the helm if the pump is not going to be used soon.

Lever on the aerator fitting is closed



Lever on the aerator fitting is open



If you find it necessary to run the baitwell pump while you are underway, you may be forcing more water than necessary up through the seacock. In this instance, adjust the seacock lever to a 45 degree angle so that the seacock is only halfway open. The seacock lever may require additional adjustments to find a setting that works best for you. Even when the baitwell pump is turned off, if the seacock is open, the baitwell tub will continue to fill with water while you are underway.

Bilge Pump

The bilge pump and float switch are installed as far aft as possible in the bilge and both are accessible via the hatch installed in the motor well. There are 2 steps in properly checking the bilge pump. First, turn the bilge pump on at the instrument panel by pressing the bilge pump switch to the on or forward position. When the bilge pump switch is in the on position, the switch light should be illuminated. To check and see if the bilge pump is operating, open the bilge hatch over the bilge pump and listen to hear the bilge pump running.

Second, turn the bilge pump off at the instrument panel and check the bilge pump float switch. The bilge pump is equipped with an automatic float switch (white box) that is mounted in close proximity to the pump. As long as your boat is equipped with an operable battery, the pump will operate automatically when water is present in the area. The float switch is equipped with two plastic knobs located on either side of the switch. Turn either one of the knobs to raise the float to engage the bilge pump. If the pump comes on, the automatic float is operating properly. It is recommended that you check the operation of each automatic float switch monthly.

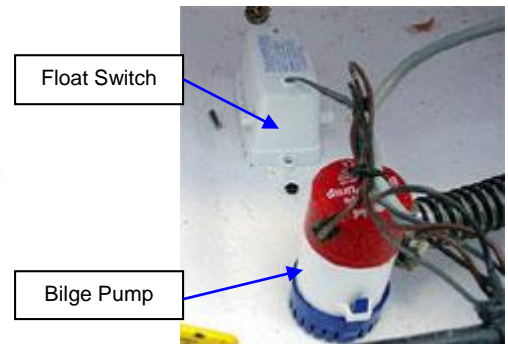

If for some reason the indicator light on your bilge pump switch comes on, check your bilge for water. It is not uncommon for rain water or water from washing your boat to accumulate in the bilge. Standing water will activate the automatic float that is connected to the bilge pump. If you notice your pump running frequently during your day on the water, you should check the thru hull fittings, hose connections, etc. for any possible leaks.

Keep the bilge area clean and free from debris that could clog ports or inhibit float movement. Also, keep the **House** battery that provides power to the bilge pump charged. If the battery is not charged and flooding occurs, the boat could swamp causing damage and possible loss of life or property.

Casting Deck with Storage

Your boat is equipped with a casting deck with a storage box that can be used for your gear. Additionally, it is insulated so it can also be used as a fish box:

Note: The casting deck storage box is plumbed to gravity drain via a thru hull on the side of the boat.

Fish Boxes

Your boat is equipped with one or more fish boxes and they are plumbed to gravity drain via a thru hull on the side of the boat. Please refer to the Specifications section of this owner manual for capacity information.

Fuel/Oil Systems

Fuel Fill Fitting

The vented fuel fill fitting is labeled “Gas” or “Fuel” and is located approximately amidships on the starboard gunwale. Twist the cap to open the fitting. The cap is connected to the fitting by a chain or cable so that it will not fall into the water and/or get lost. Be careful not to pump fuel into any other fitting on the vessel. While you are filling the tank, fuel entering the tank pushes air in the tank out through the fuel vent.

Note: Never pump fuel into any fitting, opening or access on the boat unless it is labeled “Gas” or “Fuel”.

Fuel Sender and Fuel Pick Up

The fuel sender and fuel pick up are accessible via the access pie that is installed aft of the helm seat. The fuel sender is equipped with a float that moves up and down with the fuel level in the tank. The fuel level information is sent to the fuel gauge and keeps you informed of the approximate fuel level in the tank. If you feel that your fuel gauge is reading incorrectly, before considering changing the gauge, have your Pro-Line dealer’s Service Department or a qualified professional remove the fuel sender and check to make sure that the float is able to move up and down freely. We DO NOT recommend that you inspect or change the fuel sender yourself. This should be done by a qualified professional.

Fuel Tank

The fuel tank on your Pro-Line is constructed of flame resistant cross-linked high-density polyethylene. The fuel tank is located under the deck and is secured between the stringers and bulkheads.

Inspect all hose connections on a regular basis. You can access the other end of the fuel fill and fuel vent hoses via the 6" deck plate that is installed just below the fuel fill on the inside the cockpit.

Located below the access pie Installed aft of the helm seat.

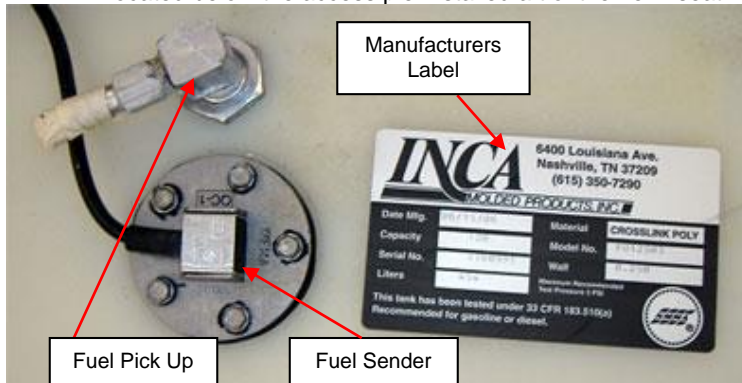

Located below the access pie installed forward of the helm seat and aft of the console.

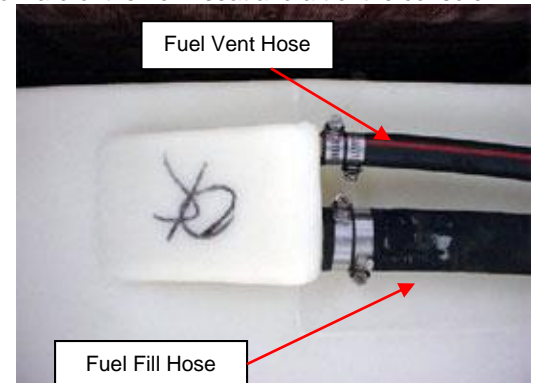

Fuel Water Separator

Depending on your selection of the various optional engine packages, your boat may be equipped with a fuel water separator for the engine. However, some engines come equipped with a built in fuel water separator. Please refer to the owner's manual provided by the manufacturer of your engine package for operational procedures and for information related to the care and maintenance of their product. When in doubt, always defer to the engine manufacturer's instructions and/or recommendations.

If your engine package requires the installation of a fuel water separator, it will be mounted to a stringer or bulkhead in the bilge. The "spin on" filter cartridge should be renewed every season at a minimum. Fuel tanks that are not kept full accumulate water faster due to condensation. Therefore, the filter cartridge may need to be replaced more often depending upon usage and conditions or if motor begins to run rough. When replacing the filter cartridge for the fuel water separator, coat the rubber seal with a film of grease or oil to help prevent sticking.

If water should somehow enter your fuel tank via condensation, your fuel source, etc., it will become trapped in the fuel water separator before it is able to travel through the fuel system and to your engine.

Please refer to the owner's manual provided by your engine manufacturer for proper procedures. Some engines will not have a separate fuel water separator located in the bilge. Instead it will be located on the engine itself. Check engine specs.

Primer Bulb

There may be a primer bulb installed for the engine and it is used to prime the fuel pump in the motor with fuel. Squeeze the primer bulb a few times until resistance is felt in order to prime. If no resistance develops and the fuel pump will not prime, you may be out of fuel, the primer bulb may be defective, or a leak may have developed allowing air into the system. Primer bulbs (if applicable) are located with the rigging tubes where they exit the bilge and are easily accessible at the transom.

Note: Not all engines require a primer bulb. Refer to the engine manual for verification.

Oil Tank and Fill

Depending on your selection of the various optional engine packages (i.e., oil injected outboard engines), your boat may be equipped with a remote oil tank. If your engine package requires the installation of an oil tank, it will be mounted in the bilge and can be accessed via the bilge hatches in the motor well. The oil fill will be installed port side of the transom.

Make sure that the oil tank is well stocked with the type of engine oil that is recommended for your engine. Refer to your engine manual. It is imperative that the oil supply remains clean and uncontaminated by water or dirt. Check to make sure the oil line is free from leaks, kinks and chafing. Some motors use a primer bulb to initiate oil flow. Air may periodically enter the system and require purging. Refer to your engine manual for specific instructions.

If your optional engine package requires the installation of a remote oil tank, please refer to the owner's manual provided by the engine manufacturer for operational procedures and for information related to the care and maintenance of their product. When in doubt, always defer to the engine manufacturer's instructions and/or recommendations.

Fuel / Oil Leaks

The fuel tank is vented via the vented fuel fill fitting and the vent should be inspected for obstructions regularly. Verify that all of the fuel hoses remain properly secured and located according to NMMA standards. Inspect all hose clamps and fittings to ensure they are double clamped where needed and that there are no fuel leaks in any of the hoses. Also, inspect the oil system, if applicable, and ensure that the oil tank and hoses remain properly connected and secured.

If you notice a fuel odor or see fuel in the bilge, there may be a leak somewhere in the fuel system. Correct any fuel leaks before operating the vessel.

Caution: If at all possible, any fuel tank and or fuel system repair should be handled by your Pro-Line dealer's service department or by another qualified professional.

Windows, Storage, Hatches and Latches

Windshield

The Plexiglas windshield assembly is molded to fit the console. DO NOT use commercially available glass cleaners containing harsh chemicals such as ammonia or alcohol as this will permanently damage the windshield. Please refer to the Service and Care section of this manual for cleaning recommendations.

Hatches and Latches

To open the hatches just lift the handle of the latch from the recessed area of the hatch, twist it and lift the hatch open. Make sure that all hatches are closed and secured before you get underway.

In addition to the deck hatches, there are round access pies installed on the boat that provide access to components below the deck.

Storage

Your boat has plenty of storage areas for your tackle and/or gear:

- Rope locker storage at the bow
- Wet/dry storage compartment in the casting deck storage box
- Center console
- Drink holders

Rod Holder Storage – All Classic Series boats include four vertical thru bolted rod holders installed on the console. Some Classic Series models may include an additional pair of gunwale mounted rod holders.

Hardware

Cleats

Cleats are installed to provide areas to permit you to tie off the boat at dockside, tie off to another boat that is anchored, secure bumpers/fenders, and/or tie off the anchor when dropped to prevent the line from pulling on the windlass, etc. You should never use the cleats for towing another boat or skier.

Hand Rails

Bow Handrail - The bow handrail is constructed of stainless steel. The railing, which is through bolted to the gunwale, is provided for safety. Never use the bow rail to tie off to anything heavier than a bumper/fender. Do not use the bow rail for anchoring, or to tie off to the dock or another boat. Do not use the bow rail to tow another boat or skier. Never stand on the bow rail or use it as leverage when pulling up an anchor, a fish or any other objects. Do not use the bow rail to tie off and/or secure a large catch, etc.

Gunwale Trim / Rubrail

Your Classic Series boat is equipped with rigid vinyl rubrail which is installed at the juncture of the deck and hull. This durable trim provides a nice clean look and serves as somewhat of a cushion when you are docking, coming along side another vessel, etc.

See the Service and Care section of this manual for cleaning recommendations.

Thru Hull Fittings

Durable plastic thru hull fittings are installed to provide overboard drainage for the following areas:

- Bilge
- Cockpit
- Casting deck storage
- Baitwell
- Fish box

Drain Plug

Before launching the boat, always make sure that the drain plug has been installed in the fitting on the transom at the keel. If your boat is being transported, remove the drain plug once the boat is secured on the trailer so that any excess water can be drained via the fitting. Never remove the drain plug when the boat is sitting static in the water.

If you live in an area where it snows and you are storing your boat on a lift during the winter, make sure that you remove the drain plug. When the snow melts, if the float switch for the bilge pump happens to fail, it could flood the bilge and damage electrical components in the bilge.

Cockpit / Deck Drains

Cockpit drains are installed in the aft area of the cockpit that allow excess water in the cockpit to drain overboard via thru hulls on each side of the boat. To ensure that there is no blockage in any of the hoses connected to the drains, it is recommended that you occasionally run water through each of the cockpit drains and visually inspect the thru hulls to verify that water flows freely and that there is no blockage. To trouble shoot, check the hoses for leaks and make certain that all hose connections are secure.



Half Dive Platform with Ladder (Optional)

The ladder on the dive platform allows you easy boarding and lets you easily stow away the step.

Bimini Top (Optional)

The frame is made of anodized aluminum and the Bimini canvas top is made of high quality Sunbrella canvas. Please see the Service and Care section of this manual for cleaning and care recommendations.

Canvas T-Top (Optional)

The anodized aluminum frame comes with a canvas top. See the Service and Care section of this manual for cleaning recommendations for the anodized aluminum frame and the canvas top.

Note: Pro-Line installs mounting pads to the frame for additional support when outriggers are factory installed. Before adding after market outriggers, we recommend that you consult your Pro-Line dealer's Service Department or another qualified service professional to add mounting pads to the T-Top frame

Seating

The helm seat is equipped with a combination cooler seat and a flip flop backrest. Both the seat cushion and backrest are cushioned and covered with a durable vinyl.

Vinyl Upholstery

Please see the Service and Care section of this manual for information on how to clean and care for your seat cushions and/or other vinyl covered products.

Operation and Performance

Trim / Tilt

The power trim system allows the operator to raise and lower the motor(s) throughout an infinite number of settings between its upper and lower limits. There is a trim setting that will yield maximum speed, stability or maneuverability for every throttle setting. Refer to your engine manual for specific questions regarding the trim and tilt.

For most conditions, the best all-round performance is obtained when the bow of the boat is slightly out of the water and all motors are trimmed to the same degree.

General trim down (or "in") characteristics are:

- Starting position for best acceleration to plane.
- Lowers the bow, which provides better stability and ride in rough water.
- Reduces boat speed and economy due to increased drag of hull and drive.
- More spray over bow.

General trim up (or "out") characteristics are:

- Raises the bow of the boat out of the water resulting in less hull in the water.
- Greater speed and economy for a given throttle setting.
- Greater maneuverability; provided prop does not ventilate during the maneuver.
- In excess, the reduced stability can lead to bouncing, porpoising and propeller ventilation.

In addition to providing ideal boat performance, the power-trim/tilt enables the motors to be raised (tilted up) for trailering, beaching and launching. Avoid operating the trim switch if travel of the motor is blocked or it has reached the limits of travel.

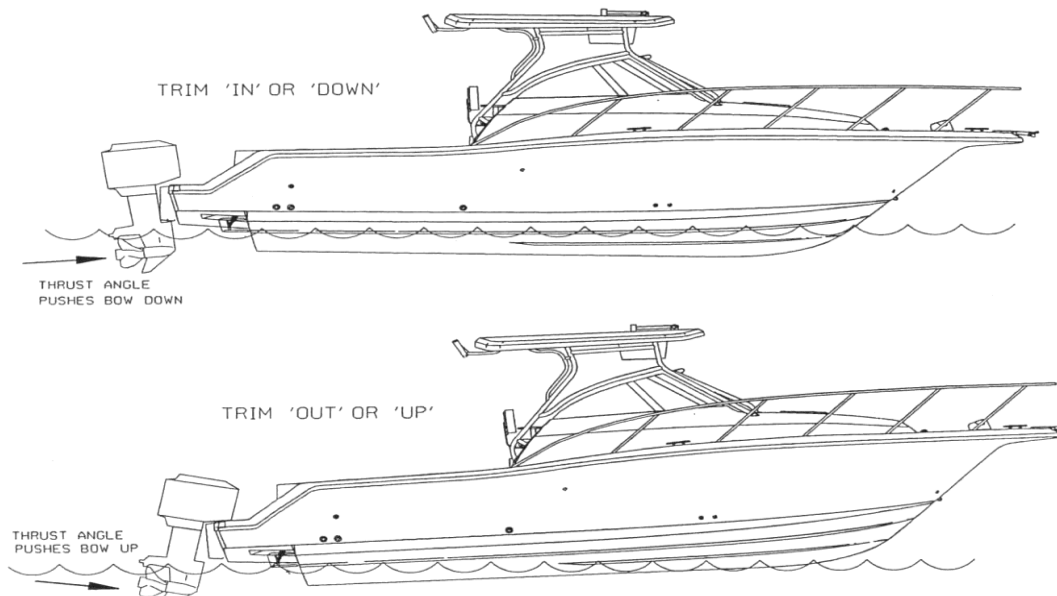

Propellers

If your Pro-Line was ordered with a factory installed engine, it will have a propeller that has been performance tested to provide the best all-round performance for your engine/hull combination at sea level. In some situations, it may be desirable to re-prop your Pro-Line to enhance the desired performance needs for your area. For instance:

- Decreasing the pitch will enhance acceleration and power at high loads.
- Increasing the pitch will increase speed at light loads.
- Decreasing the diameter will compensate for any loss of power at high altitudes.
- Increasing the diameter results in higher efficiency at low speeds at the expense of top end speed and acceleration.

Be sure not to over rev the engine when re-propping or engine damage could result. Operating your engine with a damaged prop will decrease performance, increase fuel consumption, and may introduce undesirable handling characteristics. The vibration caused by running a damaged prop could cause costly damage to your lower drive unit.

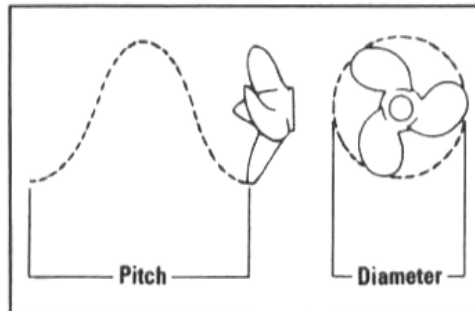

Starting

Follow the information in your engine manual if it deviates from the following instructions.

Before Starting the Engines:

- Ventilate all enclosed spaces.
- Visually inspect the bilge for fuel and check for vapors.
- Visually make sure that the propellers are clear of obstructions or swimmers.
- Make sure that the engine cooling water intakes are submerged.
- Lock the helm seat to face straight forward.
- Attach the safety stop switch lanyard.

Starting the Engines:

Start the engine according to the instructions provided in your engine manual.

After Starting the Engines:

After your engine starts, make sure to observe a few basic rules to insure the engine is functioning properly:

- Verify engine cooling water circulation.
- Check the temperature gauge for the first few minutes to make sure the engine is warming properly and not overheating.
- Check for fuel, oil and water leaks. If any leaks are found, shut down the engines and make the necessary repairs before continuing on with your voyage.
- Follow the break-in procedures as recommended by the engine manufacturer for your engines.

Fueling

Certain precautions must be observed when fueling due to the explosive nature of gasoline.

Before Fueling:

- Secure the boat to the dock with adequate moorings.
- Turn off the engine and any equipment having spark-producing contacts.
- Close doors and hatches so fumes do not enter boat.
- Disembark all persons not necessary for the fueling operation.
- Prohibit all smoking and open flames on board and nearby.
- Have a fire extinguisher close by.

While Fueling:

- Keep the nozzle in contact with the fuel fill opening to minimize the possibility of sparks.
- Do not pump fuel into any opening unless it is marked "Fuel" or "Gas".
- Do not leave the boat unattended.
- Do not spill fuel.
- Do not over fill. Filling a tank until fuel is vented is dangerous.
- Allow room for expansion.

After Fueling:

- Close the fuel fill opening.
- Wipe up any spilled fuel and dispose of the rags on shore.
- Open the doors and hatches to ventilate the boat before starting the engines.
- Check for fumes in the bilge and continue to ventilate if fumes are present.

Loading

The performance of any boat is contingent upon the amount of load carried. Reduce the load to permit safe operation in rough and adverse conditions. Heavy loads reduce the performance and increase fuel consumption. The load positioning greatly affects the performance of your boat. If excessive weight is placed too far aft, the boat may have difficulty getting on plane and may ride rough. If the load is concentrated too far forward, the boat may "bow steer" or veer off to the side when entering a large wave at an angle. There may also be a reduction in the top end speed. The optimum load location is generally near the center of the boat.

When loading your Pro-Line, always:

- Maintain a balance both port to starboard and bow to stern.
- Keep heavy items as low as possible.
- When boarding, step (never jump) into the boat one passenger at a time.
- Pass gear from the dock to someone in the boat. Do not carry gear while boarding.
- Never allow passengers to hang their feet over the side of the boat.
- Do not allow passengers to sit or stand on top of the stern or gunwales.
- Do not overload the boat to the point where water enters the cockpit scuppers.

Trailer and Launching

Selecting A Trailer

Choose the proper trailer for your boat and make sure the trailer you use is certified. Consult your state authority for state regulations pertaining to trailering a boat. More damage can be done to a boat by the stress of road travel than by normal water operation. A boat hull is designed to be evenly supported by water. Pro-Line does not make or recommend the use of any particular trailer. We do, however, recommend using the bunk style trailer in lieu of a roller style trailer. The bunk style provides the hull of the vessel with a much more even distribution of weight.

When transported on a trailer, your boat should be supported structurally, as evenly across the hull as possible. This will allow for even distribution of the weight of the hull, engine and equipment. It should be long enough to support the whole length of the hull but short enough to allow the lower unit of the boat's engine to extend freely.

- Rollers and bolsters must be kept in good condition to prevent scratching and gouging of the hull.
- Tie-downs and lower unit supports must be adjusted properly to prevent the boat from bouncing on the trailer. The bow eye on the boat should be secured either with rope, chain or turnbuckle in addition to the winch cable. Additional straps may be required across the beam of the boat.
- The capacity of the trailer should be greater than the combined weight of the boat, motor, and equipment. Check the certification label on the forward port (left) side of your trailer to insure it has an adequate gross vehicle weight rating (GVWR) for the combined boat and trailer.
- The tow vehicle must be capable of handling the weight of the trailer, boat and motors, as well as the weight of the equipment, which will be carried inside. The boat weight must include the weight of the empty hull, motors, full fuel and fresh water capacities, accessories, equipment, and provisions. This may require that the tow vehicle may need to be specially equipped with:
 - Engine of adequate power.
 - Transmission designed for towing.
 - Larger cooling systems for the engine and transmission.
 - Heavy-duty brakes.
 - Load bearing hitch attached to the frame, not the bumper.

Rollers, if used, should only serve to guide the boat into position while in the water and should not be relied upon to support the weight of the boat. The improper use of rollers voids your warranty and could seriously damage your hull.

Check Before You Go Out On The Highway

- Insure that the hitch on the tow vehicle is rated for the gross total weight (GTW) or greater and that the ball size matches the trailer receiver.
- The tow ball and coupler are the same size and the bolts with washers are tightly secured. (The vibration of road travel can loosen them.)
- The coupler is completely over the ball and the latching mechanism is locked down.
- The trailer is loaded evenly from front to rear as well as side-to-side. Too much weight on the hitch will cause the rear wheels of the tow vehicle to drag and may make steering more difficult.



- Too much weight on the rear of the trailer will cause the trailer to "fishtail" and may reduce traction or even lift the rear wheels of the tow vehicle off the ground.



- The safety chains are attached crisscrossing under the coupler to the frame of the tow vehicle. If the ball were to break, the trailer would follow in a straight line and prevent the coupler from dragging on the road.

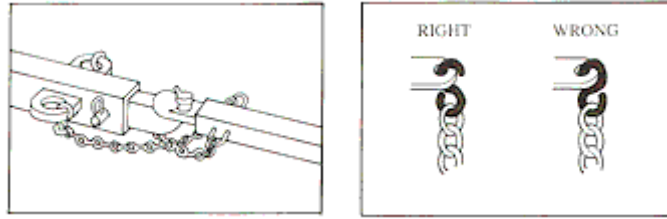

- The lights on the trailer function properly.
- Check the brakes. On a level parking area roll forward and apply the brakes several times at increasing speeds to determine a safe stopping distance.
- The side view mirrors are large enough to provide an unobstructed rear view on both sides of the vehicle.
- Check tires (including spare) and wheel bearings. Improper inflation may cause difficulty in steering. When trailer wheels are immersed in water (especially salt water), the bearings should be inspected and greased after each use.
- Carry a spare tire and tools for changing. Include a spare bearing and race set for long trips.

Towing Precautions

- Allow more time to brake, accelerate, pass and stop.
- Remember, the turning radius is also much greater. Curbs and roadside barriers must be given a wide berth when negotiating corners.
- Prior to operating on the road, practice turning, backing up, etc. on a level, un-congested parking area.

Make certain that water from rain or cleaning has been removed from the boat. Water weighs approximately eight pounds per gallon and can add weight that will shift with the movement of the trailer.

Backing A Trailer

Practice backing with a trailer *before* you get into a confined launch site. Get accustomed to using the trailer in an open area. Take someone with you who knows how to back a trailer. Backing a trailer works the opposite of backing a car. If the trailer needs to travel to the right, turn the steering wheel to the left and vice versa. Do not turn the wheel too far or over steer. Turn the wheel gradually until you get the feel of safe backing.

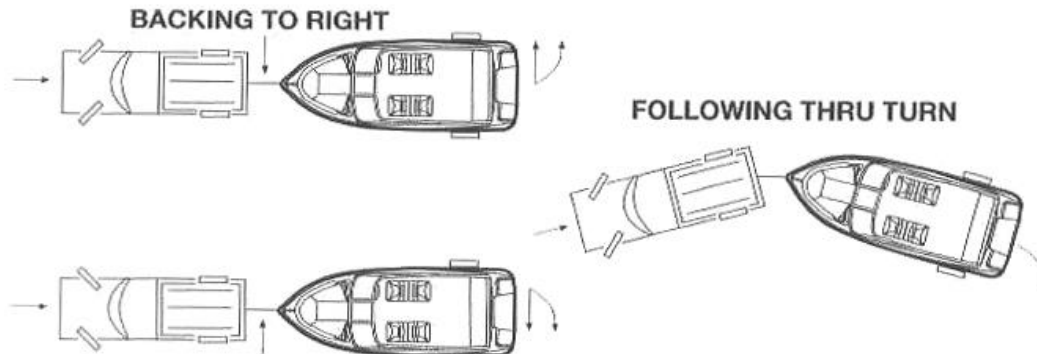

Pre-Launching Preparations

For the courtesy of others and to prevent rushing, prepare your boat for launching away from the ramp.

- Check the boat to ensure that no damage was caused by the trip.
- Remove any covers and tie downs.
- Place lines and fenders, if needed.
- Verify that your safety equipment is aboard.
- Raise the lower unit (remove supports) to the proper height for launching so that it will not hit bottom.

- Remove tie-downs and make sure that the winch is properly attached to the bow eye and locked in position.
- Put the drain plug in securely.
- Disconnect the trailer lights to prevent shorting of the electrical system or burning out a bulb.
- Attach a line to the bow and the stern of the boat so that the boat cannot drift away after launching and it can be easily maneuvered to a docking area.
- Visually inspect the launch ramp for hazards such as a steep drop off, slippery area and sharp objects.

When everything has been double checked, proceed slowly to the ramp remembering that your boat is just resting on the trailer and attached only at the bow. The ideal situation is to have one person in the boat and one observer at the water's edge to help guide the driver of the tow vehicle.

Launching

- Keep the rear wheels of the tow vehicle out of the water. This will generally keep the exhaust pipes out of the water. If the exhaust pipes become immersed in the water, the engine may stall.
- Set the parking brake and place tire chocks behind the rear wheels.
- Make sure someone else on shore is holding the lines attached to the boat.
- Lower the motor and prepare to start the engine (after running blowers and checking for fuel leaks).
- Start the boat motor and make sure that water is passing through the engine cooling system.
- Release the winch and disconnect the winch line from the bow when the boat operator is ready.
-

At this point, the boat should be able to be launched with a light shove or by backing off the trailer under power. Finish loading your boat at a sufficient distance from the ramp so that others may use it.

Retrieval

The steps for removing your boat from the water are basically the reverse of those taken to launch it. However, keep in mind that certain conditions may exist during retrieval that did not exist during launching. As you approach the takeout ramp, take special care to note such factors as the change in wind direction and/or velocity, the change in current and/or tide, any increase in boating traffic, visibility, etc.

- Unload the boat at a dock or mooring if possible.
- Back down the ramp so that the trailer is half submerged.
- Maneuver the boat carefully to the submerged trailer, and raise the lower unit of the engine.
- Carefully line up the boat, slowly maneuvering with short bursts of power.
- When the keel is centered and the boat is just touching the trailer winch, smoothly apply power until the boat eases to the bow rest.
- Winch the boat onto the trailer and secure it.
- Drive the trailer with the boat aboard carefully out of the ramp to a designated parking area for cleanup, reloading, and an equipment safety check.
- Remove the drain plug.
- Rinse off the salt water as soon as fresh water is available.
- Stow the equipment, canvas, etc. and affix the tie downs and covers.
- Hook up the trailer lights and verify their operation.

Practice will make launch and retrieval a simple procedure. The best advice is just, "do it cautiously with safety as your main concern."

Storage

Since your boat may be sitting on its trailer for quite some time before it is used again, it is important that it be stored properly. To avoid damage from sun and weather, cover the boat with a tarp. To remove weight from the wheels, put cinderblocks or wood beams under the tongue and all four corners of the trailer frame.

Service and Care

To enjoy trouble free use of your Pro-Line, follow the recommended procedures and instructions relating to the service and care of your boat. Failure to follow proper maintenance practices will result in shorter life of your equipment and may void your warranty.

Much of the installed equipment on your Pro-Line is warranted separately. Follow the care instructions found in your owner's packet to keep these individual warranties in force.

Your engine manual contains service information relating to your particular engine installation. Follow the engine manufacturer's recommendations for trouble free service and to preserve your warranty rights.

Your new Pro-Line boat is your home away from home. Generally, you should maintain your boat with the same care as you would maintain your home or automobile. Many of the same products used in caring for your home and automobile can be used to maintain your new boat.

Fiberglass and Gelcoat

The gelcoated fiberglass on your Pro-Line provides a smooth, easy to clean and maintain surface. Regular cleaning and waxing will preserve the finish on your boat for many years to come.

Use a mild detergent and plenty of fresh clean water to swab down the exposed gelcoat on your boat. Do not use harsh cleaners containing ammonia, chlorine or abrasives. Do not use acetone or any ketone solvents. Stubborn stains may be removed with alcohol or kerosene provided they are washed off immediately and completely with a mild detergent and water.

Wax all gelcoat surfaces a minimum of twice a year, more often if the boat is stored in the sun. If neglected, the surface will take on a dull appearance that is not restorable by waxing. Hand buff with a rubbing compound such as Dupont No. 7, or power buff with Mirror Glaze No. 1. Then follow up with a good waxing.

Caution: When power buffing, use care not to leave swirl marks or "burn" the surface. You may want to leave power buffing to a professional.

The gelcoat on your Pro-Line is approximately 25-mil thick. Minor scratches and deep stains that do not penetrate the gelcoat can be lightly wet sanded with 600 grit sand paper, buffed and waxed to remove.

If a deep gouge to the surface occurs that goes through the gelcoat and into the fiberglass, it must be repaired promptly to avoid further damage. Your dealer is best equipped to handle this repair and achieve good bonding and color match. There are many different gelcoat repair kits on the market for this use. However, results obtained may not be satisfactory. See your Pro-Line dealer for fiberglass damage deeper than 1/16 inch.

Epoxy Barrier Coat and Bottom Paint

If your boat will be in the water continuously, we recommend sealing the bottom of the hull with a high quality barrier coating. Unsealed gelcoat may form water blisters. Repair of water osmosis blister damage is not covered under the limited warranty.

The phenomenon of osmotic blistering is known to occur in saltwater, brackish water and/or fresh water. Any boat left in the water for any period of time is susceptible. Nearly all the marine bottom paint manufacturers today offer coatings that help protect the hull against blistering. If required, contact your Pro-Line dealer's Service Department or another qualified service professional for further information.

We recommend that your boat be cleaned often to prevent unwanted marine growth on the hull and to maintain ultimate high performance. The bottom of your boat must be kept clean. Any buildup of marine life from water will create drag and affect the boat's performance and efficiency. Never use brushes or scouring pads on the bottom of your boat, as this can cause small scratches that will actually trap dirt.

Antifouling bottom paint is designed to dissolve slowly to prevent marine growth. Therefore, the hull bottom should be repainted at the beginning of each boating season. Factors to take into consideration when selecting a protective bottom paint are water temperature, pollution, salinity, current and organic material in the water.

Important: Consult your Pro-Line dealer's Service Department or another qualified service professional for recommended bottom paints and local laws that may govern your area. Many states regulate the chemical content of bottom paints to meet environmental standards and regulations.

Blisters are unforeseen and unexplained phenomena that are relatively undefined. There is no 100% method of prevention, although barrier coating and bottom painting are the best known deterrents.

We recommend that a professional apply the epoxy barrier coat and bottom paint. The hull should be sanded prior to applying the barrier coat and bottom paint. This is done so that the epoxy coat will properly adhere to the hull, and when done correctly, will not void the hull warranty. Pro-Line Boats does not recommend using an etching primer in lieu of sanding the bottom.

Bottom painting is an annual operation but may require more frequent applications if the bottom becomes scratched, damaged, etc. We recommend strict adherence to the manufacturer's recommendations when barrier coating and bottom painting your vessel. There is a small window of time in which the coats must be applied in order to properly complete the application process; therefore, we recommend that a qualified professional do this process.

While barrier coating and bottom painting are the best preventative to blisters caused by the environment, this is in no way a guarantee that they will not occur.

Graphics

Your graphics may be cleaned with a mild dish cleaning soap and warm water or a good marine grade cleaner that is recommended for cleaning gelcoat. Never use any harsh chemicals, abrasive cleaners or any hard objects, as they will damage the graphics. Be sure to read the manufacturer's directions carefully before using any product on your graphics or gelcoat.

Gunwale Trim/Rubrail

The gunwale trim/rubrail that is installed at the juncture of the deck and hull is made of flexible, semi-rigid vinyl. The rubrail should be cleaned with the same products used to clean the gelcoat.

Baitwell Pump

The round filter attached to the side of the pump should be removed and cleaned often with clear water.

Fuel Water Separator

If fuel water separators are installed on your boat, the "spin on" filter cartridges should be renewed every season at a minimum. Fuel tanks that are not kept full accumulate water faster due to condensation. Therefore, filter cartridges may need to be replaced more often depending upon usage and conditions or if motors begin to run rough. When replacing the filters for the fuel water separators, coat the rubber seal with a film of grease or oil to help prevent sticking.

Compass

During periods of long storage, it is recommended that you remove the compass from the boat and store it in a location providing normal room temperature. At low temperatures, an air bubble may form on the top of the dome. This will in no way affect the reading or accuracy. When restored to normal temperature, the air bubble will disappear.

Clean the Lucite compass dome carefully with a moistened soft cloth to avoid scratching. In saltwater operation, salt crystals from the spray may form on the dome. These crystals should be removed with a moistened soft cloth. A dry cloth and/or harsh rubbing may scratch the compass dome. Any good grade of paste wax can be applied to the dome to retain its luster and optical clarity.

Aluminum

Aluminum is corrosion resistant but not corrosion proof. The grain structure, when modified by welding processes, has increased susceptibility to micro-corrosion (invisible to the unaided eye) and cracking. Proper care will preserve the weld strength and beauty of your aluminum:

- Always clean frequently with a mild non-abrasive soap and lots of fresh water. Most glass cleaners work.
- Always protect with a wax, especially around welds to guard against micro-corrosion, cracking and rust spots.
- Always remove rust and corrosion spots, as they appear, with an aluminum cleaner.
- Thoroughly wash the aluminum with a soft towel or sponge using lots of soap and water. Remove all dried salt crystals and other contaminants. Rinse completely with direct water pressure.
- Clean and rinse it well.
- Wash it often enough to keep contaminants from forming or building up.
- Avoid the use of bleach or chlorides to clean the aluminum and/or nearby components. Chlorides can leach onto the aluminum when nearby.
- Never clean with acids or bleaches.
- Avoid abrasive cleaning products. NEVER use sandpaper, steel wool, brass wool, wire brushes, polishing wheels, or rubbing or polishing compounds. These items will remove anodizing and lead to pitting.
- Never permit contact with iron, carbon steel, or other metals, which could cause rust or corrosion.

Pay particular attention when cleaning the tubing directly beneath the top (i.e., T-top, Bimini top). This area does not receive the natural rinsing action of rainwater and is shielded from the sun. Therefore, it does not dry as completely or quickly as the rest of the frame. The top of the frame is often overlooked when cleaning the boat and should be hand washed and dried often. This area is likely to be the first place that staining or pitting occurs.

Additional information from Taco Metals is included in your owner's package.

Stainless Steel

Stainless steel is not completely free from corrosion attack. It is NOT stain or rust proof. When used in contact with chloride salts, sulfides or other rusting metals, stainless will discolor, rust or even corrode. The degree of surface oxidation is directly affected by local atmosphere and saltwater concentrations. All metals are subject to corrosion in some environments. The grain structure of stainless, when modified by welding processes, has increased susceptibility to micro-corrosion (invisible to the unaided eye) and cracking.

Our most helpful recommendation is that you give your stainless steel hardware the same attention that you would use to maintain other materials on your boat. Regular fresh-water washing with a mild abrasive cleaner will keep your stainless bright and beautiful.

- Always clean stainless frequently with soap and water. Any cleaner safe for glass is usually safe for stainless
- Always remove rust spots as soon as possible with a stainless, brass, silver or chrome cleaner. Irreversible pitting will develop under rust that remains on stainless for any period of time.
- Always use a cleaner, like a good car wax, for added beauty and protection.
- Never use coarse abrasives like sandpaper or steel wool on stainless as these can cause rusting.
- Never clean with acids or bleaches.
- Never leave stainless in contact with iron, steel or other metals, which cause contamination leading to rust or corrosion.
- Always protect with a wax, especially around welds to guard against micro-corrosion, cracking and rust spots.

Additional information from Romac and G. G. Schmitt and Sons is included in your owner's package.

Windshield

The windshield is made of Plexiglass. To clean the windshield:

- Rinse with fresh water to remove as much grime as possible
- Do not grind dirt, soil, saltwater residue, etc. into the windshield, as this will permanently damage the windshield.
- If further cleaning is required, the windshield manufacturer recommends cleaning the windshield with a mild soap (preferably Ivory liquid soap), lukewarm water and a soft cloth. Make sure that there is no cross contamination on the cloth. Allow the windshield to air dry. If you feel that you must dry the windshield, use only a very very soft cloth.
Note: Do not clean the windshield with any window cleaner designed specifically for glass windows or any cleaner containing harsh chemicals such as ammonia or alcohol as this will permanently damage the windshield.

Never use any harsh chemicals, abrasive cleaners or any hard objects, as they will permanently damage the windshield.

Bimini Top and T-Top Canvas

Canvas

One of the best ways to keep Sunbrella brand fabrics looking good and to delay the need for deep or vigorous cleanings is to hose fabrics off on a monthly basis with clear water. This practice will help prevent dirt from becoming deeply imbedded in the fabric and eliminate the need for more frequent vigorous cleanings. In most environments, a thorough cleaning will be needed every two to three years. When it's time for a thorough cleaning, Sunbrella fabrics can be cleaned while still installed on your boat. It is important to observe the following:

- Brush off loose dirt.
- Hose down.
- Prepare a cleaning mixture of water and mild soap (Ivory Snow, Dreft or Woolite - no detergents). Water should be cold to lukewarm. Never more than 100 degrees.
- Use a soft bristle brush to clean.
- Allow soap to soak in.
- Rinse thoroughly.
- Air dry. Never apply heat to Sunbrella fabrics.

If stubborn stains persist, you can use a *diluted chlorine bleach/soap mixture* for spot cleaning of mildew, roof run-off or other similar stains. Prepare a special cleaning mixture:

- Four ounces (half cup) of chlorine bleach.
- Two ounces (one-fourth cup) of mild soap.
- One gallon of water.
- Clean with soft bristle brush.
- Allow mixture to soak for up to 20 minutes.
- Rinse thoroughly.
- Air dry.
- Repeat if necessary.

Re-treating the Fabric - Sunbrella fabrics are treated with a fluorocarbon finish to enhance water repellency. This finish is designed to last for several years, but must be replenished after a thorough cleaning. Based on test results, Glen Raven recommends [303 High Tech Fabric Guard™](#) as the preferred re-treatment product for Sunbrella fabrics. Fabrics should be retreated after thorough cleaning or after five years of use. Check with your local Sunbrella dealer or distributor for additional information.

For more information, visit the Sunbrella website at www.sunbrella.com for specific recommendations.

Vinyl

Exterior Vinyl – Upholstered Seats and/or Cushions

Vinyl requires periodic cleaning to maintain its neat appearance and to prevent the build-up of dirt and contaminants that may permanently stain and reduce the life of the vinyl if they are not removed. The frequency of cleaning depends on the amount of use and on environmental conditions to which the vinyl is subjected. The procedures used for cleaning are dependent upon the end use circumstances.

For normal cleaning, most stains can be cleaned using warm soapy water and a clear water rinse. Moderate scrubbing with a medium bristle brush will help to loosen soiling material from the depressions of embossed surfaces. For stubborn stains, use either Fantastic or Mr. Clean, which are commercially available mild detergents, in accordance with manufacturer's instructions.

For additional information regarding the care and maintenance of this product, please refer to the Morbern brochure provided in your owner's package for recommended methods to clean specific types of stains.

Corrosion Protection

Spray all electrical connections with a good quality corrosion guard annually and whenever an electrical connection is repaired or replaced.

If you moor your Pro-Line in salt water for extended periods, be sure to check the transom mounted anti-corrosion anode often for operation. Check the electrical connections (green wire) on all metallic fittings with anode for conductivity with an ohmmeter. Make sure the anode surface is exposed and not caked with corrosion and scale. Renew the anode if it is more than 50% eroded. Your motor and/or drive unit have a sacrificial zinc anode to mitigate the effects of electrolysis which causes corrosion. Maintain this anode in accordance with the maintenance schedule in your engine manual.

Winterizing and Storage

Your new Pro-Line was winterized before it left the factory. If you launch the boat prior to storing it for the winter, please complete and/or comply with the following check list in order to ensure an easy "fitting out" in the spring:

Pre-Storage Check List:

- Remove drain plugs, keeping the bow high to drain any water accumulation.
- Run a pint of RV antifreeze through the bilge pump.
- Drain all water systems, including the head, and pump an approved antifreeze through all pumps, valves, drains and lines.
- Fill fuel tank (3/4 – 7/8 full) and add a stabilizer/conditioner such as "STA-BIL" to the gasoline.
- Prepare engine in accordance with the engine manufacturer's recommendations found in your engine manual.
- Treat metal parts with a rust inhibitor.
- To prevent mold and mildew, use an absorbing product such as DampRid according to the manufacturer's directions. An alternative and inexpensive option is to fill egg cartons with charcoal briquettes that have not been pre-treated with lighter fluid.
- Remove batteries and protect them from freezing. Trickle charge overnight once a month.
- Place under cover. If the boat is stored on a trailer, loosen tie-down straps and place blocks beneath axles to relieve the load on the tires.

For inboard/outboard engines only, to protect your boat during transport, the following procedures were affected at the factory prior to shipping and will need to be rectified prior to launch:

- Drain plugs on engine block removed.
- Petcocks on engine removed.
- Large hose on re-circulating pump removed.
- Power steering cooler hose removed.
- All other water hoses disconnected (left in place with hose clamps tightened to prevent their loss).

Fitting Out After Storage

- Check entire fuel system for loose fittings, leaks and damage.
- Clean battery terminals; install battery(s), and coat terminals with a deoxidizing agent.
- Check all thru hull fittings and hoses for obstructions, water tightness and condition.
- Test all lights for proper operation.
- Check wiring, terminal blocks and plugs for loose connections and corrosion.
- Verify switch and equipment operation.
- Check line condition. Inspect anchor and rope.
- Clean out any debris from bilge and cockpit.
- Flush water systems.
- Install hull drain plug.
- Verify operation of equipment before leaving dock.

Resealing

In the heat and sun, silicone and sealant can degrade over time. We recommend that you reseal around everything that comes in contact with the deck or hull with a high quality silicone such as 3M 5200 sealant annually. This includes but is not limited to the following:

- Clam shell at the anchor locker
- T-top stanchions and supports
- Access and other hatches
- Bow and transom eyes
- Bimini top hardware
- Bow rail stanchions
- Thru hull fittings
- Windshield
- Motor mounts
- Grab rails
- Rubrail
- Ladder
- Cleats

Additional Cleaning and Maintenance Products

Flitz

For use on brass, copper, stainless steel, chrome, silver, gold, pewter, nickel, factory gun bluing, bronze, platinum, tin, aluminum, magnesium, anodized aluminum, painted surfaces, fiberglass, Plexiglas and plastics. Flitz is available at many marine supply stores, marinas and at Home Depot. For more information on this product, contact the manufacturer at:

Flitz International Ltd., Waterford, WI 53185, 800-558-8611

Woody Wax –Can be used on a variety of surfaces such as:

- Aluminum and Metals – T-tops, tuna towers, anodized aluminum, aluminum, stainless, chrome, boat trailers, fishing gear, etc.
- Fiberglass and Non-Skid – Fiberglass, non-skid decks and colored gelcoat.
- Electrical and Engines – Electrical equipment, electrical connections, wiring harnesses, outboards, engines.
- Plastics – Plastic, vinyl seats, Plexiglas.

Be sure to read the manufacturer's information carefully before using Woody Wax products on any component on your boat. For more information regarding this product, visit their website at www.woody-wax.com.

Tef-Gel - Bed all SS fasteners that come in contact with aluminum with Tef-Gel to prevent the galvanic corrosion between these two dissimilar metals. Log onto the Tef-Gel website at (<http://www.wolfwire.com/tefgel/frameset.htm>) for more information,

Ivory Soap and clean warm water – no cross contamination

Lysol Foaming Cleaner – Works well for cleaning gelcoat, vinyl and Formica.

Appendix

Helpful Checklists

Print and use these checklists, and do not operate your boat without doing the following:

Each Time You Go On A Boat Trip

- Make sure you know where CO exhaust outlets are located on your vessel.
- Educate all passengers about the symptoms of CO poisoning and where CO may accumulate.
- When docked or rafted with another boat, be aware of exhaust emissions from the other boat.
- Confirm that water flows from the exhaust outlets when the engines and generator are started.
- Listen for any change in exhaust sound that could indicate an exhaust component failure.
- Test the operation of each CO alarm by pressing the test button.

Once A Month

- Make sure all exhaust clamps are in place and secure.
- Look for exhaust leaking from exhaust system components. Signs include rust and/or black streaking, water leaks, or corroded or cracked fittings.
- Inspect rubber exhaust hoses for burned, cracked or deteriorated sections. All rubber hoses should be pliable and free of kinks.
- Clean the bilge and all bilge components with a mixture of bleach and water. Then, follow up by misting the bilge and components with WD-40. This includes but is not limited to the hoses, seacocks, pumps, connections, clamps, air conditioner pumps, generator, etc.

Once A Year

Have a qualified marine technician:

- Replace exhaust hoses if cracking, charring or deterioration is found.
- Ensure that your engines, generator and air conditioner are properly tuned and well maintained.
- Inspect each water pump impeller and the water pump housing. Replace if worn. Make sure cooling systems are in working condition.
- Inspect all metallic exhaust components for cracking, rusting, leaking or loosening. Be sure to check the cylinder head, exhaust manifold, water injection elbow and the threaded adapter nipple between the manifold and the elbow.
- Clean, inspect and confirm proper operation of the generator cooling water anti-siphon valve (if equipped).
- Spray CRC on all of the connections behind the console.

Trouble Shooting Chart

PROBLEM:	POSSIBLE CAUSE
Poor speed or fuel economy:	Wrong propeller for load or conditions. Trim is in too far. Load is too far forward or too heavy. Boat has taken on water. Marine growth on hull. Line or anchor is dragging. Fuel is stale or partially blocked. Engine is worn, out of tune or underpowered. Improper rigging. Air intake or exhaust is partially blocked.
Engine cranks but will not start:	Out of fuel. Filter is clogged. Fuel line kinked or fuel vent plugged. Water in fuel. Engine problem (electrical, fuel pump, blockage, etc.). Safety stop switch lanyard not installed.
Engine will not crank:	Drive is in gear (check operation of the throttle release). Battery is weak. Terminals corroded or loose. Engine or drive is damaged.
Engine runs but boat will not go:	Throttle release is engaged. Disconnected shift linkage. Damaged prop, or lower drive unit. Entangled in lines or weeds. Anchor is down.
Prop cavitates:	Trim out too far. Motor is too high. Weeds on prop. Bow heavy, damage to hull. Prop is damaged.
Excessive vibration:	Propeller, engine, or drive unit damaged. Hull damaged.
Boat will not turn:	Steering unit needs fluid or has trapped air. Tiller is disconnected (helm turns). Steering trunion or mechanism jammed (helm won't turn).
Electrical problems:	Corroded wires, terminals or plugs. Broken, loose or short circuited wires. Circuit breaker tripped. Defective switch, device or breaker. In-line fuse blown. Overloaded circuit.
Handling problems like:	
Porpoises	Trimmed out too far, damaged hull (rocker), trim tabs up, stern heavy.
Runs wet	Trimmed in too far, bow heavy, trim tabs down, overloaded for conditions.
Hard ride	Stern heavy, trimmed out too far, going too fast for conditions.
Lists	Loaded to one side, trim tabs set wrong, trimmed too far in, fuel tanks uneven.
Over bank in turn	Trimmed in too far, improperly located load, throttle advanced too far.
Catches in turns	Damaged hull (hook), stern heavy, trim tabs down.

Boat Identification Information

Owner: _____

Home Port: _____

Dealer: _____

Boat Name: _____

Registration Number: _____

Hull ID Number: _____

Boat Model: _____ LOA: _____ Beam: _____ Draft: _____

Vertical Clearance: _____ Hull: _____ Deck: _____ Interior: _____

Warranty Registration Date: _____

Fuel Capacity (Gallons): _____

Ignition Key #: _____

Other Key #: _____ Other Key #: _____

Radio Call Letters: _____ Bat.: _____

Engine Make: _____ Model: _____ HP: _____

Port Engine S/N: _____ Port Drive S/N: _____

Center Engine S/N: _____ Center Drive S/N: _____

Stbd Engine S/N: _____ Stbd Drive S/N: _____

Prop: Diam: _____ Pitch: _____ P/N: _____

Trailer Make & Model: _____

Trailer S/N: _____ GVWR: _____

Insurance Company: _____

Agent: _____

Policy #: _____ Phone #: _____