

# PRO•LINE

## BOATS

# 2009 Owner's Manual

# 29

## Express



Specifications subject to change without notice. Actual boats may vary from drawings and/or photos.  
Copyright 2005 Pro-Line Boats Inc., PO Box 1348, Crystal River, FL 34423  
All rights reserved. April 2, 2008



# Table of Contents

	Page
<b>Introduction</b>	
Specifications .....	1
Dealer Responsibilities.....	1
Customer Responsibilities .....	2
Owner's Package .....	2
Yacht Certification .....	2
Insurance and Registration .....	2
Warranty .....	2
<b>Safety</b>	
Carbon Monoxide.....	5
Emergency Treatment for CO Poisoning.....	5
Where CO May Accumulate .....	6
How To Protect Others and Yourself .....	6
Fire.....	7
Equipment .....	7
Flooding.....	8
Hazardous Conditions.....	8
Passenger Safety .....	8
Regulations .....	8
Rules of the Road .....	8
Alcohol.....	9
<b>Controls</b>	
Throttle and Shift Controls (Twin) .....	10
Ignition – Binnacle, Forward, Neutral and Reverse Gear Operation .....	10
Key Switch Alarm .....	10
Lanyard Stop Switch .....	10
Electronic Throttle and Shift Controls (Optional).....	10
Shift / Throttle / Trim.....	11
Steering - Hydraulic with Tilt .....	11
Hydraulic Steering (Verado – Power) .....	11
Steering – Power Assist (Optional).....	11
Power Trim .....	12
Steering Wheel.....	12
Trim Tabs .....	12
Trim Tab Indicators .....	13
Windlass with Rode and Chain (Optional).....	13
Windlass Foot Switch (Optional).....	13
Bow Thruster .....	13
<b>Systems and Accessories</b>	
Electrical System.....	15
110 Volt Outlets - GFI Protected.....	15
12-Volt Receptacle.....	15
Switch and Breaker Panel.....	15

	<b>Page</b>
Circuit Breakers.....	17
Battery Charger.....	17
Battery Switch for Dual Batteries.....	18
Alternating Current and Direct Current Panels (AC/DC Panel).....	18
Alternating Current (AC).....	18
Direct Current (DC).....	19
Generator – 5.0 kw Gas (Optional).....	19
Blower.....	21
Shore Power with Cord.....	22
Lighting Systems.....	22
Baitwell Light.....	22
Bilge Lights.....	22
Cabin Lights.....	22
Courtesy Light - Cabin.....	23
Cockpit Lights.....	23
Navigation and Anchor Lights.....	23
Underwater Lights (Optional).....	23
Spreader Lights and Courtesy Light (Optional).....	24
Remote Spot Light (Optional).....	24
Air Conditioning System with Heater (Optional).....	24
Instrumentation.....	26
Horn.....	26
Compass.....	27
Full Instrumentation / Gauges (Digital).....	27
Fuel / Oil Systems.....	28
Fuel Fill and Vent.....	28
Fuel Tank.....	28
Fuel Sender and Fuel Pick Ups.....	28
Fuel Water Separators.....	29
Primer Bulbs.....	29
Oil Tank and Fill.....	29
Fuel / Oil Leaks.....	30
Sea Water System.....	30
Baitwell Pump.....	30
Washdown Pump and Raw Water Washdown.....	31
Bilge Pumps.....	31
Fish Boxes with Macerator Pumps.....	32
Fresh Water System.....	32
Fresh Water Stations.....	32
Fresh Water Pump.....	33
City Water Hook-Up / Inlet.....	33
Fresh Water Tank Fill.....	33
Fresh Water Tank.....	33
Water Heater (Optional).....	34
Shower System and Shower Sump Pump.....	34
Head Waste System.....	34
What is the Law?.....	34
Dockside Discharge Waste Outlet.....	34
Vacuum Flush Head System with Holding Tank.....	34
Overboard Discharge (Optional).....	35

	<b>Page</b>
Cabin Appliances and Accessories .....	35
Alcohol / Electric Stove .....	36
Refrigerator .....	37
Microwave (Optional) .....	37
AM/FM Stereo with CD Player, Speakers and Remote (Optional) .....	37
XM Stereo Upgrade (Optional) .....	37
Upgraded Stereo Package (Optional) .....	38
Flat Screen Television with DVD Player and Cable Outlet (Optional) .....	38
Windows, Storage, Hatches and Doors.....	38
Windshield – Tempered Glass with Vent.....	38
Windshield Wipers .....	38
Windows .....	39
Storage .....	39
Hatches and Latches .....	40
Transom Door .....	41
Cabin / Companionway Door .....	41
Hardware .....	41
Cleats .....	41
Bow Pulpit with Anchor Roller and Rope Locker Storage .....	41
Bow Rail .....	41
Thru Hull Fittings .....	42
Grab Rails.....	42
Gunwale Trim / Rubrail .....	43
Drain Plug.....	43
Cockpit / Deck Drains.....	43
Dive Platform - Integrated with Ladder .....	43
Seating .....	43
Hard Top with Storage Box (Optional).....	44
Hard Top with Storage Box and Outriggers (Optional) .....	44
Cabin Interior.....	44
Cabin Floors .....	44
Upholstery .....	44
Countertops.....	46
Wood Grain Cabinetry and Cabin Table.....	47
Electronics (Optional).....	47
Galvanic Isolator.....	47
Bonding System .....	47

## **Operation and Performance**

Trim / Tilt.....	48
Propellers .....	48
Starting .....	49
Before Starting the Engines .....	49
Starting the Engines.....	49
After Starting the Engines .....	49
Fueling.....	49
Before Fueling .....	49
While Fueling.....	50
After Fueling .....	50
Loading.....	50

**Service and Care**

Fiberglass and Gelcoat .....	51
Epoxy Barrier Coat and Bottom Paint.....	51
Graphics .....	52
Gunwale Trim / Rubrail .....	52
Fuel Water Separators .....	52
Water Pumps .....	52
Compass .....	52
Aluminum.....	53
Stainless Steel.....	53
Corrosion Protection .....	54
Cabin / Companionway and Transom Doors.....	54
Tackle Box.....	54
Windows .....	54
Windshield.....	55
Curtain Package and Windscreen .....	55
Canvas .....	55
Isinglass.....	56
Vinyl.....	56
Interior .....	56
Exterior .....	56
Cloth .....	57
Cabin Cushions, Pillows and Curtains.....	57
Appliances.....	57
Refrigerator .....	57
Microwave .....	57
Stove .....	57
Flooring.....	57
Laminated Wood Grain Flooring.....	57
Teak and Holly .....	57
Countertops.....	58
Formica.....	58
Winterizing and Storage.....	58
Resealing.....	59
Additional Cleaning and Maintenance Products.....	59

**Appendix**

Helpful Check Lists .....	60
Each Time You Go On a Boat Trip .....	60
Once a Month.....	60
Once a Year .....	60
Boat Identification Information .....	61
Trouble Shooting Chart.....	62

While we endeavor to be as accurate as possible, certain changes in standard equipment, options and the like may have occurred which would not be included in the Owner's Manual. All weights and fuel capacities are estimates and could/will vary with each vessel and with each application. In all cases, consult your local Pro-Line dealer for the most current information.

# Introduction

Congratulations on the purchase of your new Pro-Line Boats 29 Express sport fishing boat. Welcome into the proud family of satisfied Pro-Line owners. Every expedition lets you enjoy the outstanding features designed into every boat we construct. Your new Pro-Line is more than just a boat, it's a whole new lifestyle.

Pro-Line's commitment to the needs and wishes of the sport fishing family has resulted in a superior fishing craft providing you with comfort, performance, security, and outstanding fishability. All of our boats comply with U.S. Coast Guard (USCG) safety regulations and are designed and crafted in accordance with the National Marine Manufacturers Association (NMMA), the American Boat and Yacht Council (ABYC) standards, and the Common European directive (CE).

This manual (to be kept onboard your Pro-Line) is designed to provide you with information necessary for the safe, efficient operation and care of your new Pro-Line. Take the time now to carefully review the owner's manual and the additional information in your owner's package to maximize your enjoyment and safety as well as familiarize yourself with your new boat.

We have prepared this manual to help you fully enjoy each voyage while operating your boat safely. While the information in the manual cannot and does not cover every boating situation, we urge you to read this manual carefully and familiarize yourself with the boat before using it. If a specific method or procedure is not recommended, you must make sure that whatever action you take is safe for you, your passengers and others on the water. Always use common sense when boating.

## Specifications

Length Overall (LOA)	29' 4"	Bridge Clearance	8' 3"
Beam	9' 8"	w/ Hard Top	10' 0"
Draft (Hull)	22"	Fuel Capacity	200 gallons
Deadrise	22 degrees	Baitwell Capacity	35 gallons
Weight		Fishbox Capacity (2)	125 gallons
Hull – w/o Engines	7,500 lbs.	Freshwater Capacity	39 gallons
Trailerable	10,000 lbs.	Water Heater Capacity (optional)	6 gallons
Cockpit Area	63 sq. ft.	VacuFlush Holding Tank Capacity	
Cockpit Depth	28"	w/ Dockside Discharge (Std)	9.5 gallons
Maximum Horsepower	600 hp	w/ Overboard Discharge (Opt)	10 gallons

## Dealer Responsibilities

Your dealer's responsibilities include but are not limited to:

- Pre-delivery verification of proper rigging and operation. Deliver the boat in water ready condition unless you and your dealer have agreed upon other arrangements.
- Complete the pre-delivery checklist with the customer at the time of delivery.
- Provide adequate orientation in the general operation of your Pro-Line including an explanation of the specific safety considerations regarding the use of the systems and components.
- Provide an explanation of the owner's package and literature, including the warranty registration cards for the vessel, engines and all of the separately warranted equipment and accessories.
- Discuss the terms of all warranties and emphasize the importance of registering each warranty with the specific manufacturers.
- Repair any damages that may have occurred to the boat while the boat has been in the dealer's possession.
- Provide service to Pro-Line boat owners within the locality of the dealership.
- Explain local and out of area service procedures during and after the warranty periods.

## Customer Responsibilities

- Review and sign the Pre-Delivery Inspection (PDI) report for the boat and motors with your dealer to ensure that your boat is in top condition when you take delivery.
- Examine the boat at time of delivery to insure that all systems and components are functioning safely and properly. Report any outstanding issues (i.e., scratches, missing items, etc.) to your dealer before or during the delivery of the boat.
- Read all literature and instructions to ensure proper usage and operation of the equipment as well as how to use and maintain all equipment as directed.
- Read and understand the limited warranty. Sign the warranty registration card and mail it to Pro-Line Boats.
- Contact your local Pro-Line dealer for assistance with any warrantable repairs.
- Transportation of your boat to and from your dealer or repair facility for warrantable repairs.
- Schedule your 20-hour boat and engine check up with your dealer.
- Know your boat and the rules of the road before you use your boat.
- Be proficient in boat handling and safety. This manual is not intended to provide complete training on all aspects of general boat operations. We at Pro-Line urge all boat owners and operators to attend a boating safety course before operating a boat.

## Owner's Package

Each Pro-Line boat comes with an Owner's Package that contains this Owner's Manual along with materials supplied by various manufacturers whose products have been installed on your boat. Manufacturers of certain products (i.e., Stereo, TV, Stove, Refrigerator, Microwave, Engines, Electronics, etc.) provide their own limited warranty and owner's manuals. While we have endeavored to be as accurate as possible in this manual, if you should notice a discrepancy between the information in this manual and that of the individual supplier's manual, *always follow the instructions in the supplier's manual.*

Make sure that you complete the individual warranty cards for these products and forward them on to the respective manufacturers to register for your warranty with them. Retain all materials in your Pro-Line Owner's Package for easy reference.

## Yacht Certification

In accordance with the National Marine Manufacturers Association (NMMA) and the American Boat and Yacht Council (ABYC), all boats larger than 26 feet in length are required to be Yacht Certified. Therefore, a per person and/or pound capacity is not assigned to vessels over 26 feet in length. It is up to the operator's discretion to determine a safe load. These yacht standards are based on Standards and Recommended Practices for Small Craft published by the ABYC, 3069 Solomons Island Road, Edgewater, MD 21037 (410-956-1050).

## Insurance and Registration

As the owner of the boat, you are legally responsible for all liabilities of operation. Secure **insurance protection** with a reputable insurance company through your local insurance agent.

Learn about and operate your boat in accordance with local, state, and federal laws, regulations, and **registration** requirements.

## Warranty

The Pro-Line Boats Limited Warranty is attached to the warranty card. After signing the warranty card, your dealer will provide you with your copy of the warranty and mail the warranty card to Pro-Line Boats, Inc. A copy of the Pro-Line Boats Limited Warranty is also included in this chapter.





The Pro-Line Boats Limited Warranty extends only to parts that were factory installed. Dealer installed items are the responsibility of the dealer. All warrantable repairs are to be completed by an authorized Pro-Line dealer. Your dealer should be able to assist you with any service or warranty related issues.

If for any reason you are dissatisfied with the services performed by your dealer, we suggest that you discuss the matter with the service manager. The service manager is responsible for the quality of service being performed and has a direct interest in resolving your issues to your satisfaction. If the matter is complicated and cannot be resolved to your satisfaction by the service manager, we suggest that you talk to the general manager or owner. In most cases a compromise can be reached.

If the matter cannot be resolved by the dealership to your satisfaction, contact the Pro-Line Boats Customer Service Department by calling 352-795-4111 or by writing to:

Pro-Line Boats, Customer Service Dept.  
PO Box 1348  
Crystal River, FL 34423-1348  
FAX: 352-795-9373

So that your dealer and we can provide you with the best possible service, please have the following information available when calling or writing:

- HIN (Hull Identification Number)
- Selling dealer's name and location
- Servicing dealer (if different from selling dealer)
- Nature of problem
- Names of dealership personnel involved with the situation
- Record of service performed and approximate dates

**When contacting Pro-Line Boats, please keep in mind that your issue will most likely be resolved at the dealership, using their facilities, equipment, personnel and/or sublet repair facilities.**

Note: There are items that are **not covered** by the Pro-Line Boats Limited Warranty, including but not limited to the following:

- Incidental and consequential damages (i.e., storage charges, telephone or rental charges of any type, inconvenience or loss of time or income).
- Damage caused by neglect, lack of maintenance, accident, abnormal operation, improper installation or service.
- Haul-out, launch and towing charges.
- Transportation charges, service call charges and/or travel time to and from a repair facility, customer's home or marina.
- Service requested by customer other than that which is necessary to satisfy the warranty obligation.
- Oils, lubricants or fluids used in normal maintenance.
- Air freight, next-day or second-day air, or any special delivery fees unless pre-approved.
- Gelcoat cracking, chalking, crazing, discoloration, yellowing or blistering.
- Hull blisters that form below the water line: Osmosis blistering is not covered by our limited warranty. The phenomenon of osmotic blistering is known to occur in salt water, brackish water and/or fresh water. Any boat left in the water for any period of time is susceptible. Most marine bottom paint manufacturers offer coatings that help protect the hull against osmosis blistering. We highly recommend that you add a protective coating to your hull. Find out which type of bottom paint is recommended for your area and have an epoxy barrier coat and bottom paint applied by a professional.
- Parts not installed by the factory

The Ten Year Limited Hull Structural Warranty is transferable to subsequent owners for a nominal fee. Please contact your dealer or Pro-Line Boats to obtain the applicable transfer form so that the new owner will have piece of mind knowing that their pre-owned boat comes with the same structural hull warranty protection that was afforded to the original owner.

#### PRO-LINE BOATS LIMITED WARRANTY – 2009 MODEL YEAR

**Ten Year Limited Hull Warranty.** Pro-Line warrants to the original retail purchaser ("Purchaser") that for ten (10) years after the date of delivery to its original retail purchaser, each new fiberglass hull manufactured by Pro-Line shall be free from structural defects due to material or workmanship under normal non-commercial use. Hull structural defects are defined as the separation or delamination of the stringers or delamination of the one-piece fiberglass shell below the hull and deck flange.

**One Year components warranty.** Pro-Line warrants to Purchaser that for one (1) year after the date of delivery to its original retail purchaser, all boat components manufactured by Pro-Line shall be free from defects due to material or workmanship under normal non-commercial use.

**Exclusions.** This limited warranty does not cover and does not extend to any of the following:

- (a) Hull or component failure caused by normal wear and tear, climatic conditions, misuse, neglect, lack of proper maintenance, accident, fire or other casualty damage, racing, overloading, negligence, modification, or commercial use;
- (b) Windshield leakage or breakage; (c) components or equipment not originally installed by Pro-Line; (d) components repaired or replaced unless repaired or replaced in accordance with this warranty; (e) fading, chalking, blistering or cracking of any varnish, gel-coat, paint, anti-fouling coating, or metallic finish; (f) tears, cracking, fading, discoloration or mildewing of curtains, cushions, tops, headliners, or other fabric or upholstered items; (g) cost of removal or reinstallation of any component (including components manufactured by Pro-Line), or disassembly and reassembly of the unit containing the component; (h) speed, weight, fuel consumption, and other performance characteristics of the boat. **ANY ORAL STATEMENT OR PRINTED ADVERTISING REGARDING ANY PERFORMANCE CHARACTERISTIC OF THE BOAT OR ITS COMPONENTS SHALL BE CONSIDERED AN ESTIMATE ONLY AND SHALL NOT BE RELIED UPON AS EXPRESS WARRANTY OR AS A BASIS OF THE BARGAIN FOR THE BOAT OR ITS COMPONENTS;** (i) electrolysis, galvanic corrosion, crevice corrosion, or any deterioration of underwater components; (j) components not manufactured by Pro-Line, whether or not warranted by the other manufacturer, even if installed by Pro-Line, including but not limited to engines, propellers, generator sets, controls, electronics, batteries, appliances, and air conditioning. Warranties provided to Pro-Line by component manufacturers shall be passed on to purchaser to the extent that such transfer is permitted by the manufacturer, Pro-Line's selling dealer will identify the authorized service dealer for any such components upon request.

**Limitations.** THE REPAIR OR REPLACEMENT OF DEFECTIVE PARTS SHALL BE THE PURCHASER'S SOLE AND EXCLUSIVE REMEDY AND PRO-LINE'S SOLE AND EXCLUSIVE LIABILITY UNDER THIS WARRANTY. Pro-Line's obligation under this warranty is limited to the repair or replacement (at Pro-Line's sole election) of any covered item found to be defective, when delivered by Purchaser pursuant to written authorization and instructions from Pro-Line, round-trip transportation prepaid, to Pro-Line's manufacturing plant or other designated repair facility. Repaired or replaced items are warranted as provided herein for the unexpired portion of the applicable warranty period.

THIS WARRANTY, AND THE RIGHTS AND REMEDIES UNDER IT, IS EXCLUSIVE AND IS GIVEN IN PLACE OF ALL OTHER WARRANTIES, WHETHER EXPRESSED OR IMPLIED, INCLUDING ANY IMPLIED WARRANTY OF MERCHANTABILITY OR FITNESS FOR PARTICULAR PURPOSE, WHETHER ARISING BY LAW, CUSTOM, CONDUCT, OR USAGE OF TRADE. PURCHASER'S REMEDIES SHALL BE LIMITED AS STATED HERE-IN AND PRO-LINE SHALL NOT BE LIABLE FOR ANY INCIDENTAL, CONSEQUENTIAL, OR INDIRECT DAMAGES OR LOSSES RESULTING FROM DEFECTS.

THIS LIMITED WARRANTY GIVES PURCHASER SPECIFIC LEGAL RIGHTS. PURCHASER MAY HAVE OTHER RIGHTS WHICH MAY VARY FROM STATE TO STATE. IN THE EVENT THAT IMPLIED WARRANTIES ARE FOUND TO EXIST UNDER THE LAW OF A PARTICULAR STATE NOTWITHSTANDING THE EXCLUSION CONTAINED HEREIN, THE DURATION OF ANY SUCH WARRANTY SHALL BE LIMITED TO THE DURATION OF THE APPLICABLE LIMITED WARRANTY STATED HEREIN.

THE SELLING DEALER IS NOT AN AGENT OF PRO-LINE OR A CO-WARRANTOR AND IS NOT AUTHORIZED BY PRO-LINE TO AMEND, MODIFY THIS LIMITED WARRANTY IN ANY MANNER.

**Pre-delivery Examination.** Purchaser represents to Pro-Line that Purchaser has examined the boat and all its component parts, accessories and equipment, to Purchaser's full satisfaction prior to accepting delivery of the boat from Pro-Line, or in the alternative, has been given full opportunity to do so and has declined.

**Transferability of Warranty.** This limited warranty may be transferred to subsequent purchasers of the boat during the warranty period, provided that such subsequent purchaser pays the required transfer fee to Pro-Line and registers his ownership with Pro-Line within thirty (30) days of such purchase.

**Miscellaneous.** Pro-Line Boats is a division of American Marine Holdings, LLC. Pro-Line reserves the right to make changes in the design and construction of its products at any time, without notice and without any obligation to incorporate such changes into products of prior manufacture. This limited warranty applies to new boats manufactured by Pro-Line, except as such limited warranty may be transferred to a subsequent purchaser as provided herein. The term "new boats" shall include boats that may have been repaired during the manufacturing process as part of Pro-Line's quality assurance program. This limited warranty contains the entire agreement between both Pro-Line and Purchaser and supercedes all other prior agreements, discussions, negotiations, commitments, and representations, whether oral or written, between them regarding Pro-Line's warranty. If any provision of this limited warranty, or the application of it, is determined to be invalid or unenforceable for any reason, the remainder of this limited warranty and the application of it shall not be affected.

All communications and notices from Purchaser regarding this limited warranty should be sent to: PRO-LINE BOATS, Customer Service Dept., PO Box 1348, Crystal River, Florida 34423-1348. Telephone: (352)-795-4111.

**Acknowledgement of Limited Warranty.** By signing the accompanying warranty card, Purchaser, (or each Purchaser, if more than one) agrees that he or she has read a copy of this limited warranty in its entirety and understands its terms and conditions. Purchaser (or each of them) acknowledges receipt of a copy of this limited warranty at the time of sale.

# Safety

Your Pro-Line boat has been constructed with safety in mind. But, remember, boating safety and the safety of your passengers is YOUR ultimate responsibility. You should fully understand the operations of your vessel as well as the basics in boating safety.

Your local U.S. Coast Guard Auxiliary (USCGA) and the U.S. Power Squadrons (USPS) offer excellent safe boating classes several times a year. If you have not already passed a boating safety course, we recommend that you do so at your earliest convenience.

Plan your trips carefully. Insure ample fuel supply and a reserve. Tell someone where you are going and when you expect to return. Keep current charts onboard. Read USCG boating safety circulars and follow the safety guidelines.

## Carbon Monoxide

Be aware of and avoid conditions that can cause Carbon Monoxide poisoning (see USCG boating safety circular 77). Sources of Carbon Monoxide (CO) include any gas or diesel engine and any flame from items such as a charcoal grill, stove or heater. Carbon Monoxide can accumulate to deadly levels in enclosed spaces. Always ventilate occupied areas of the vessel with fresh clean air.

In high concentrations, CO can be fatal within minutes. The effects of CO in lower concentrations are cumulative and can be just as lethal over long periods of time. CO poisoning is often confused with seasickness. So be aware of the following CO symptoms: Itchy and watery eyes, flushed appearance, throbbing temples, inability to think coherently, ringing in the ears, tightness across the chest, headaches, drowsiness, nausea, dizziness, fatigue, vomiting, collapse and convulsions.

Do not stand or swim near the motor when the engine is idling.

### **Carbon monoxide can harm and even kill you inside or outside your boat!**

Did you also know:

- CO symptoms are similar to seasickness or alcohol intoxication?
- CO can affect you whether you're underway, moored or anchored?
- You cannot see, smell or taste CO?
- CO can make you sick in seconds? In high enough concentrations, even a few breaths can be fatal.

Most important of all, did you know CO poisonings are **preventable**? Every boater should be aware of the risks associated with CO - what it is; where it may accumulate; and the symptoms of CO poisoning. To protect yourself, your passengers and those around you, learn all you can about CO.

### **Emergency Treatment for CO Poisoning**

CO poisoning or toxicity is a life-threatening emergency that requires immediate action. The following is a list of things that should be done if CO poisoning is suspected. Proceed with caution. The victim may be in an area of high CO concentration, which means you or others could also be in danger from exposure to CO.

- Evaluate the situation and ventilate the area, if possible.
- Evacuate the area and move affected person(s) to a fresh air environment.
- Observe the victim(s).
- Administer oxygen, if available.
- Contact medical help. If the victim is not breathing, perform rescue breathing or approved cardiopulmonary resuscitation (CPR), as appropriate, until medical help arrives. Prompt action can mean the difference between life and death.

- Shut off potential sources of CO, if possible. Correct ventilation problems and/or repair exhaust problems as appropriate. Investigate the source of CO and take corrective action, such as evacuating and ventilating the area, or shutting off the source of the CO, while at the same time evacuating and ventilating the area.

**Where CO May Accumulate** - Carbon Monoxide can accumulate anywhere in or around your boat as shown in the following pictures:



Inadequately ventilated canvas enclosures.



Exhaust gas trapped in enclosed places.



Blocked exhaust outlets.



Another vessel's exhaust. CO from the boat docked next to you can be just as deadly.



"Station wagon effect" or back drafting.

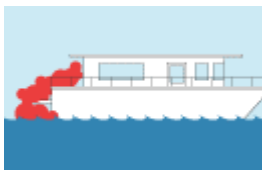

At slow speeds, while idling, or stopped. Be aware that CO can remain in or around your boat at dangerous levels, even if your engine or the other boat's engine is no longer running!

### How to Protect Others and Yourself

You are in command of your boating safety. Follow these simple steps to help keep Carbon Monoxide from poisoning you, your passengers or others around you.

- Know where and how CO may accumulate in and around your boat.
- Maintain fresh air circulation throughout the boat at all times. Run exhaust blowers whenever the generator is operating.
- Know where your engine and generator exhaust outlets are located and keep everyone away from these areas.

- Never sit, teak surf or hang on the back deck or swim platform while the engines are running. (Teak Surfing is a new and dangerous boating fad that involves an individual holding on to the “teak” swim platform of a vessel while a wake builds up then lets go to body surf on the wave created by the boat; hence the term - Teak Surfing.) Teak surfing is never a safe activity.
- Never enter areas under swim platforms where exhaust outlets are located unless the area has been properly ventilated.
- Although CO can be present without the smell of exhaust fumes, if you smell exhaust fumes, CO is also present. Take immediate action to dissipate these fumes.
- Treat symptoms of seasickness as possible CO poisoning. Get the person into fresh air immediately. Seek medical attention unless you are sure it is not CO.
- Install and maintain CO alarms inside your boat. Do not ignore any alarm. Replace alarms as recommended by the alarm manufacturer.
- Get a Vessel Safety Check. A VSC is a free bow-to-stern safety examination.

## Fire

- Be aware of and avoid conditions that can lead to accidental fire.
- Guard against and watch for fuel spills and leaks.
- Inspect wiring for damage or exposure that could lead to short circuits or arcing.
- Make sure those who smoke are careful to avoid accidental fire ignition.
- Do not allow smoking while fueling.
- Keep a USCG approved fire extinguisher on board at all times.
- Inspect the fire extinguisher regularly, learn how to use it properly and instruct others as well.
- Use water to fight a fire as a last resort after making arrangements to abandon the boat if a fire should get out of control.
- Keep the following in mind if a fire is burning out of control and you must abandon the boat:
  - Abandon the boat into the wind to minimize burn risk from floating fuel.
  - Wear a PFD unless you must swim under burning fuel.
  - If swimming under burning fuel, throw a PFD outside of the burning area and swim under the burning fuel to it.

## Equipment

USCG regulations require that you have the following Coast Guard approved equipment onboard while operating your boat:

- Fire extinguisher(s)
- Personal Flotation Device (PFD) for each occupant
- One throwable PFD
- Sound signal device
- Navigational lights if operated at night
- Sight signal device approved for day and night use when in coastal waters or the great lakes

In addition, here is a list of suggested equipment you should have aboard your Pro-Line:

- |                                     |  |
|-------------------------------------|--|
| • First aid kit and blankets        | • Anchor and sea anchor with sufficient line |
| • Mooring lines and fenders         | • Bailing device                             |
| • Combination oar/boat hook         | • Tool kit and lubricant                     |
| • Spare prop and hardware           | • Spare fasteners, hose clamps and plugs     |
| • Spare fuses and bulbs             | • Binoculars                                 |
| • Local charts and compass          | • Waterproof flashlight and spare batteries  |
| • 2 way radio                       | • EPIRB (emergency beacon)                   |
| • Floating key chain and spare keys | • Navigation device                          |
| • Emergency food and water          | • Waterproof matches or lighter              |

## Flooding

Be aware of and avoid conditions that can cause your boat to flood with water. Possible causes of flooding include:

- Damage to the hull or thru-hull fitting
- Waves washing into the boat
- Water entering cockpit due to improper loading
- Failure to properly install the drain plug.

The boat will become flooded and may swamp, capsize or sink if water enters the boat faster than the bilge pump can expel it.

## Hazardous Conditions

Keep track of weather developments and avoid hazardous conditions whenever possible. When forced to operate your Pro-Line in storm conditions:

- Wear PFD's.
- Stow loose gear and equipment.
- Place heavy items as low as possible.
- Head for the easiest port to reach a safe location.
- Reduce speed. You are moving too fast if the boat leaves the water.
- If power fails, anchor or rig a sea anchor off the bow (an empty ice chest in a pinch).
- Stay with the boat if it capsizes, unless it is burning out of control.

## Passenger Safety

You are responsible for the safety and conduct of your passengers. Make sure that:

- You instruct your passengers on the proper use and location of PFD's. Children and non-swimmers should wear one at all times.
- Each passenger is in a safe location when underway and knows to keep the boat balanced.
- At least one other person knows how to operate the boat in case of an emergency.
- Your passengers are aware of propeller dangers and the possibility of sudden maneuvers and jolts.
- The **engine is turned off and the key is removed** when swimmers are near the prop or using the dive platform.
- All passengers keep away from lines under stress in case they break and recoil.

## Regulations

The USCG is the authority of all waterways. Local authorities enforce State Boating Regulations. You are subject to marine traffic laws and "Rules of the Road" for both federal and state waterways. Therefore, you must submit to boarding if requested by the proper authority. There are many publications available from the Coast Guard concerning regulations. Call the United States Coast Guard Info Line at (800)-368-5647 for additional information.

## Rules of the Road

Know and use the "Rules of the Road". Your boat is subject to U.S. Coast Guard enforced marine traffic laws known as "Rules of the Road." There are two sets of rules: the US Inland Navigation Rules and the International Rules. The latter rules are applicable to all vessels inside the demarcation lines separating inland and international waters. You may obtain a copy of the rules from any of the following and by requesting the publication titled "Navigational Rules, International - Inland."

- Your local USGC
- The United States Coast Guard Info Line (800)-368-5647
- The USCG Headquarters by logging on to uscg.mil

The information here is only a “**brief**” overview. **Please** contact the USCG for detailed information.

- Audible warning signals:
  - One short horn blast: starboard course change.
  - Two short horn blasts: port course change.
  - Three short horn blasts: astern operation.
  - Five horn blasts: doubt about previous signal or danger.
  - A Five-second horn blast every minute: for fog operation.
- When overtaking, give-way vessel announces intention with horn blast(s) and waits for a response, then completes maneuver.
- When approaching head-on, both boats give way after giving appropriate horn blast(s) (preferably to starboard).
- When crossing, a vessel converging from starboard has the right-of-way. Port vessel gives way (both acknowledge with one short horn blast).
- Know and observe navigational buoys and markers.
- Give way to craft under sail.

## Alcohol

Don't drink and drive. If you have been drinking, appoint someone who is an experienced boater and has not been drinking to be the designated driver. Never operate a boat under the influence of drugs or alcohol. Operation of motorized vessels while under the influence is a Federal offense carrying a significant penalty.

# Controls

Controls and engine systems vary greatly from one engine manufacturer to another. Please read your engine owner's manual carefully.

Note: If your engine package was **not factory installed**, some components that are normally standard installations may not be included.

## Throttle and Shift Controls for Twin Engines

### Ignition – Binnacle, Forward, Neutral and Reverse Gear Operation

The binnacle is located at the console forward of the helm seat. To ensure that the binnacle is working properly, shift the binnacle forward to put the engine in forward gear. Make sure the engine shifts smoothly into idle with no grinding of the gears. Bring the binnacle back into neutral and repeat the same process while going into reverse. Again, ensure that there are no gears grinding. It is important to check the binnacle at wide-open throttle (WOT) to ensure the binnacle is not stiff and operates smoothly while going into the WOT position.

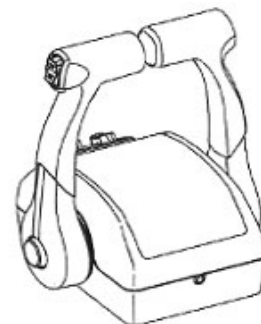

Actual binnacle will vary depending upon the engine package that was selected.

### Key Switch Alarm

The key switch alarm is located in the binnacle and sounds when the ignition key is turned on. The key switch alarm is actually a warning alarm that will go off in the unlikely event that an overheating problem occurs with the engine. To check the key switch alarm, turn the ignition key to the right but do not start the engine. The alarm will sound ensuring that the engine warning alarm is working properly. When finished, turn the key off.

### Lanyard Stop Switch

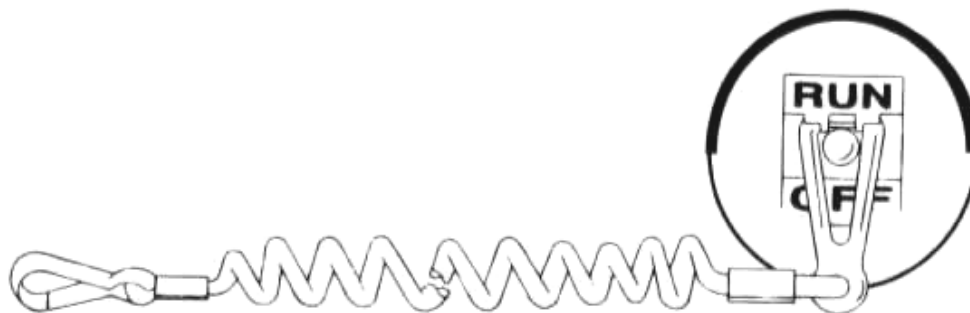

**LANYARD STOP SWITCH**

To ensure the lanyard stop switch (also called the emergency stop feature) on the engine works properly, first turn on the ignition key and start up the engine. While the engine is running, locate the lanyard stop switch. The lanyard stop switch is installed in close proximity to the binnacle or the ignition. While the engine is running in the neutral position, pull the lanyard stop switch downward until the plastic element at the end of the lanyard pulls the stop switch pin into the off position. This process will automatically stop the engine and will ensure that the emergency lanyard stop switch is working properly.

## Electronic Throttle and Shift Controls (Optional)

Some engine packages (i.e., Mercury Verado, Mercury Opti Max DTS, etc.) include electronic throttle and shift controls. This feature is also available as an option for all other engine packages. The electronic throttle and shift



controls provide easier shift and throttle functions and little or no resistance. You may occasionally feel some friction at the binnacle but this can be adjusted at the binnacle per the instructions provided by the engine manufacturer.

## Shift / Throttle / Trim

Your Pro-Line can be ordered with different shift/throttle systems based upon motor type. Refer to the owner's packet to find the manual pertaining to your particular installation. Each motor has an individual tilt/trim switch located on the port throttle lever. Separate shift and throttle controls are available for each outboard motor.

The throttle lever has three range positions: "Forward", "Neutral", and "Reverse". The shift function occurs in the first portion of the lever travel. After the transmission is shifted into gear, further movement of the lever advances the throttle.

Push the throttle lever ahead to move forward and pull it back for reverse. Centralize the lever to the detent position for neutral. The throttle lever is equipped with a neutral safety switch to prevent the motor from starting in gear. The initial short movement of the lever to engage the transmission should be made firmly to avoid causing gear clash.

**CAUTION: Use care in shifting to avoid advancing the throttle more than intended.**

## Steering - Hydraulic with Tilt

Steering systems will differ depending upon your selection of engine package. Please carefully read the owner's manual provided by the specific manufacturer. Tilt steering is included with all factory installed engine packages.

### Hydraulic Steering (Verado – Power)

Your Pro-Line is equipped with a self-contained hydraulic steering system when your engine package is factory installed. When the steering wheel is turned, the helm pump pumps fluid to the steering cylinder causing it to extend or retract. Periodically, check the fluid level and fill as necessary. Beware of adding too much fluid, especially if the ambient temperature is cold because subsequent expansion could cause leaking or damage to your system. Refer to the owner's manual that was provided by your engine manufacturer.

After every 24 hours of operation check all nuts, caps, and hose fittings for tightness. Make sure the hoses are not chafing or kinking on sharp corners. Also, check that hose ends are not damaged or distorted. The fluid should be changed annually under normal conditions and every six months during times of heavy usage. If your steering does not operate properly, check the following:

- Drive entanglements
- Level of the hydraulic steering fluid
- Hoses and/or fittings for leaks
- Air in the steering system

To properly check the steering system, start by turning the steering wheel port to starboard. If the engine does not respond the same time as the steering wheel is being turned, this means that there is air in the steering system and the steering system needs re-bleeding. When there is air in the steering, the steering wheel will feel "loose". Contact your dealer to have them bleed the steering system.

### Steering – Power Assist (Optional – Standard with Verado)

Experience the automotive style comfort hydraulic steering can achieve with power assist. It's the perfect addition for boats equipped with standard hydraulic steering. Power assist increases steering comfort with reduced wheel effort. This system is available for 150HP+ single outboards, heavy 4 stroke outboards and twin or triple outboards.



## Power Trim

The power trim unit is located on the engine and can be operated by using the trim button on the engine or by using the trim toggle switch on the binnacle. To ensure the power trim is working, start by pressing the toggle trim switch in the up position and trim the engine to the full up position. Repeat the same process by pressing the trim toggle switch down and the engine will go into the full down position. See the Trim and Tilt information in the Operations section of this manual.

## Steering Wheel

The stainless steel steering wheel is mounted at the helm along with the binnacle, switch panel and other controls. Please refer to the Care and Maintenance section of this manual for cleaning recommendations.



## Trim Tabs

The trim tabs come equipped with auto retract. The planing tabs are located on each side of the transom on the bottom of the hull. The trim tabs operate independently, up or down, to correct for differing conditions of wind or load. Refer to the owner's packet for specific information.

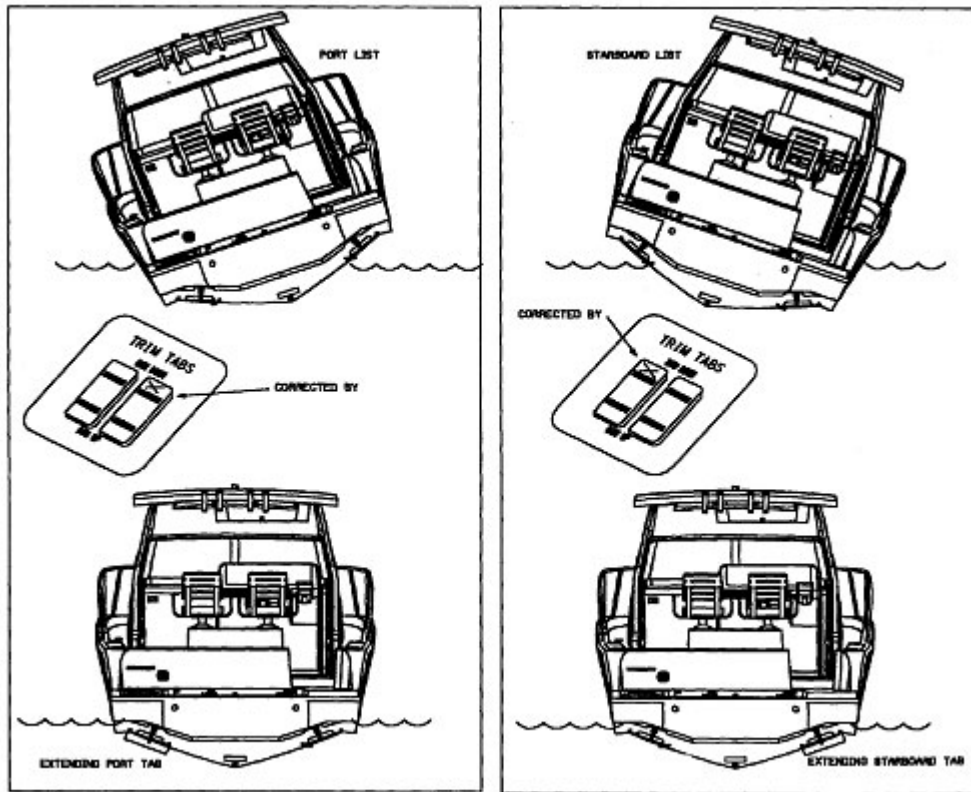

Check the operations of your trim tabs before getting underway. To operate the trim tabs locate the trim tab rocker switches on the console. Press both switches forward and hold them down. This will engage both trim tabs and will ensure they are working properly while in the full down position.

The switch on the port side operates the starboard trim tab. The switch on the starboard side operates the port trim tab. To check each trim tab individually, press one of the trim tab rocker switches forward and check to see if the opposite trim tab goes down. For example if the starboard trim tab switch is being pressed down, the port trim tab should be going down. Repeat the same process for the opposite side.

While underway and in open water, clear of other boaters, depress the top half of the switches in half-second increments to achieve the desired degree of trim. To correct a starboard list, depress the top half of the port switch in small increments until the list is corrected. To avoid over trim, allow a few seconds between tab adjustments to allow the boat to respond. If you over trim, simply give the over trimmed tab an adjustment in the opposite direction. Push the top half of both rocker switches in half-second increments to trim the bow down.

Warning: Trim tabs can cause a dramatic change in the attitude and heading of your boat. Adjust them in small increments when in open water and clear of any obstructions.

**Trim Tab Indicators (Optional)**

This trim tab indicator may be added to the factory installed standard trim tab package. The waterproof indicator and switch lights up to let you know exactly where your trim tabs are.



**Windlass with Rode and Chain (Optional)**

The optional windlass anchor system is located on the bow. It is an electric hands free anchor system that allows the driver to raise or lower the anchor while staying at the helm. The windlass comes with 200 feet of 1/2 inch line and 6 feet of 1/4 inch rode.

The windlass is operated by a separate switch and is protected by a 50-amp breaker. The switch is located at the helm. The breaker is located on port bulkhead in the bilge.



To operate the windlass, press the windlass toggle switch to the down position to release the anchor and line. After dropping the anchor, be sure to tie the line off at one of the cleats. If you do not tie off at a cleat, the constant pull against the line could cause the windlass motor to fail. To retrieve the anchor, press the windlass switch to the up position and carefully raise the anchor up but not allowing it to hit the boat.

Refer to the owner’s manual that was provided by the manufacturer of the windlass for operational procedures and information related to the care and maintenance of their product. When in doubt, always defer to the windlass manufacturer’s instructions and/or recommendations.

**Windlass Foot Switch (Optional)**

The windlass foot switch requires the installation of the windlass with rode and chain. This feature, which includes two (2) foot switches that are installed on the bow of the boat next to the windlass, lets you raise or lower the anchor simply by depressing either the up or down switch.

Refer to the owner’s manual that was provided by the manufacturer of the windlass foot switch for operational procedures and information related to the care and maintenance of their product. When in doubt, always defer to the component manufacturer’s instructions and/or recommendations.



**Bow Thruster (Optional)**

When it comes to docking in tight spaces, a bow thruster can be a true godsend – but its benefits don’t end there. As a growing number of anglers are discovering, a bow thruster can also prove useful in many fishing situations.

The increased maneuverability is a great asset when working a fish. The performance of a single- or multi-engine outboard can be enhanced when a thruster is installed, not only in terms of dockside maneuvering, but also when fighting fish. The bow thruster package includes either a joystick control or a touch pad control.

To engage the thruster, press the on/off switch; the LED light will glow. To move the boat to port, turn the joystick to the left and press the left arrow button. To move the boat to starboard, turn the joystick to the right and press the right arrow button. When the thruster is engaged, the LED light in the switch will glow.

When the thruster is not in use, make sure to disengage the thruster by pressing the on/off switch on the joystick panel; the LED light not glow.

The bow thruster is powered by its own dedicated battery (not included or factory installed), which is installed under the cabin V berth. It is wired to a battery switch that is installed in the storage compartment below the dinette seat. The battery charger charges this battery.

Refer to the owner's manual that was provided by the manufacturer of the bow thruster for operational procedures and information related to the care and maintenance of their product. When in doubt, always defer to the bow thruster manufacturer's instructions and/or recommendations.

# Systems and Accessories

## Electrical System

### 110 Volt Outlets - GFI Protected

There are 2 (two) 110 volt/ground fault interrupter (GFI) outlets installed in the cabin. One is located in the galley. The other is located on the starboard wall of the head and is protected by a plastic cover that lifts up for easy access. On the AC/DC panel, the switches for these 2 outlets are labeled Cabin Outlet 1 and Cabin Outlet 2.

### 12 Volt Receptacle

A 12-volt receptacle is installed on the console. It is easily accessible and can be used to charge your cell phone, operate a hand held remote spotlight, etc.

### Switch and Breaker Panel

The switch and breaker panel is located on the console. The numbers shown above or below each switch in the photo below correspond with the descriptions provided for each switch. Note: Actual switch locations may change due changes in selected options, etc.



- 1 Accessory - This 5 amp switch can be used for the optional flat screen television or an additional dealer installed accessory. Please check the amp rating of any new component and/or additional accessory before installation. If you have selected the optional flat screen television, see additional information on this component in the Cabin Appliances and Accessories section of this manual.
- 2 Cockpit Lights - Your boat is equipped with cockpit/courtesy lights. The lights have LED (light emitting diode) bulbs with a lifespan of approximately 10,000 hours. To activate the lights, depress the switch to the up or forward position. The lights give off a soft warm light which should not affect your night vision, but will still provide you with enough light to move around your cockpit safely in low visibility conditions.
- 3 Cabin Light (Accessory) – This switch can be used for additional dealer installed accessory. Please check the amp rating of any new component and/or additional accessory before installation. This switch is rated for 5 amps.

- 4 Baitwell Light - To activate the baitwell light, depress the switch to the up or forward position. This will activate the LED (light emitting diode) light inside your baitwell tub. It is a soft white light that will keep your bait moving and lively. It will also help you locate your bait on those early morning or late night fishing trips. To turn the light off, simply depress the switch to the down or aft position.
- 5 Windshield Vent (Accessory) – This switch can be used for additional dealer installed accessory. Please check the amp rating of any new component and/or additional accessory before installation. This switch is rated for 5 amps.
- 6 Windshield Wipers – This 3 position switch activates the port and starboard wipers. Depressing the switch to the up or forward position activates the starboard wiper. Depressing the switch to the down or aft position activates both wipers. The center position on the switch is the off position for both wipers. See additional information on this component in the Windows, Hatches and Doors section of this manual.
- 7 Navigation and Anchor Lights - Locate the Nav. Light switch on the instrument panel. This 3-way switch (forward, middle, back/aft) functions as follows when you press the switch:
  - Forward position - Turns on the bow lights and the anchor light. This position will also activate the red light in your compass.
    - If you have Faria gauges on the dash panel, this function will illuminate the gauge lights.
    - If the gauges were provided by the engine manufacturer (i.e., Mercury, Honda, etc.), your gauge lights will be illuminated when the ignition switch is turned on.
  - Middle position – All lights are off.
  - Back/Aft position – Anchor light is on; bow and gauge lights are off.
- 8 Horn - The horn is used to signal, warn, or alert other boats, swimmers or people on shore. Depress the horn switch to the up or forward position to activate the horn. Release the horn switch to deactivate the horn. Using different sequences of horn blasts indicates different and sometimes dangerous situations to you or someone around you. Avoid any horn use without an appropriate purpose. See the Safety Section in this manual and/or take a safe boating course for more information on the proper use of the horn.
- 9 Courtesy Light - To activate the cabin courtesy light, which is located at the top of the cabin stairs, depress the switch to the up or forward position. This is a LED (light emitting diode) light with an approximate life span of 10,000 hours. This light should be left on when using the vessel in low visibility conditions and should have no effect on your night vision. It can also be left on during the night as you would a night-light.
- 10 Washdown - To activate the washdown pump, which is located on top of the starboard aft stringer, depress the switch to the up or forward position. The washdown pump draws its water from the same seacock that the baitwell pump draws its water. To turn the pump off, depress the switch in the down position. Keep the washdown switch in the off position if the pump is not going to be used soon.
- 11 Baitwell Pump - The baitwell pump is located in the bilge is mounted on a seacock (ball valve). For the baitwell pump to operate properly you need to make sure the seacock is in the open position. The seacock is wide open when the yellow seacock lever is vertical. When the yellow seacock lever is horizontal, the seacock is closed.

The underside of the seacock thru-hull is equipped with a scoop to allow the water to be picked up even when the boat is on plane. When the boat is not in the water or the baitwell pump is not going to be used for an extended period of time, the seacock valve should be in the closed position. To activate the pump, depress the switch to the up or forward position. To turn the pump off after the baitwell tub is full, depress switch to the down or aft position.

- 12 Fishbox Pump Outs- This 3-position switch operates the fishbox macerator pumps that allow you to drain the water and debris from the fishboxes. The macerator pumps, which are mounted on the outside of the port and starboard aft stringers, allow you to pump all the water, ice and scales out of the boxes by grinding up the debris and discharging it overboard.

To activate either one of the pumps, depress the switch to the up or down position to activate the applicable pump. This action will drain the applicable fishbox of water and/or debris, grind up any debris and then discharge the water and/or debris overboard. When not in use, the switch should be left in the off or center position.

- 13 Bilge Lights – Two bilge lights are mounted on the port and starboard stringers to illuminate the bilge area when you are working on your boat in low visibility conditions. To activate the lights, depress the switch to the up or forward position. Make sure to leave switch in the off or down position when the bilge lights are not in use.
- 14 Bilge Pumps (Bilge 1, Bilge 2, Fwd) - Your boat is equipped with 3 automatic bilge pumps.
- 15     • Bilge 1 – This 1100 gph pump is located in the aft bilge. If your vessel is equipped with a  
16     generator, the pump is located just forward of the generator. The automatic float switch is mounted next to the pump.
- Bilge 2 - This 1500 gph pump is the high water bilge pump and it is located in the aft bilge, in close proximity to bilge pump 1. The automatic float switch for this high water pump is mounted further aft in the bilge, on the port side.
- Fwd Bilge - This 1100 gph pump is located and is accessible via the panel under the mattress in the mid berth.

All bilge pumps are wired automatic to the battery and have a manual override located at the switch panel on the console. The automatic float switches are wired directly to the **Starboard** battery terminals through breakers or inline fuses. Circuit breakers for the main and forward pumps are located at the helm next to the manual switches.

Depressing the applicable bilge pump switch (Bilge 1, Bilge 2 or Fwd) to the up or forward position activates the corresponding bilge pump. When not in use, the switches should be left in the off or down position.

### **Circuit Breakers**

Circuit breakers and/or fuses protect the wiring. In the event a device stops working, check to see if the circuit breaker is tripped or if the fuse is blown. Breakers are installed in the following locations:

- The helm main and DC main breakers are located above the dual battery switches and is accessible via the battery switch hatch located below the transom sink.
- Additional breakers and/or fuses for the bilge pumps, trim tabs, stereo memory and spare are located next to the main breaker.
- Additional breaker switches are also located on the switch panel above the individual switches.

A tripped breaker will protrude or move from its set position indicating that the circuit has been overloaded. Turn off the device(s) on the circuit, then reset the breaker by pushing in once or by returning a breaker switch to the on position. If the breaker does not reset or if it resets and then trips again after the device is turned back on, then a short circuit exists or your device may be damaged, overloaded, or faulty. Correct the problem and then reset the breaker.

### **Battery Charger – 20 amp**

The battery charger is installed in the bilge on the aft side of the forward bulkhead. It is designed to recharge your batteries and extend the life of your batteries in applications where the batteries may be stored for long periods of time. This battery charger:

- Automatically senses and distributes 100% of available charging amps to any one bank or combination of all banks
- Charges and conditions batteries with a built in safe maintenance mode for long and short term storage
- Was saltwater tested by the vendor for coastal sport fishing and boating
- Has LED power and charge Indicators



- Dynamic Thermal Output Control - Provides appropriate charging amps to your batteries while maintaining recommended charger temperature
- Has built-in protection for reverse polarity, ignition and temperature protection

### Battery Switch for Dual Batteries

The battery switches are installed behind the hatch located below the transom sink at the port aft corner of the cockpit and are installed in close proximity to the circuit breakers.

The preferred switch position is port engine to position one (1) on the port battery switch and starboard engine to position two (2) on the starboard battery switch.

To test the operations of the battery switch, place the switch in the off position and try to start up the engine(s). When the switch is off, you should not be able to start the engine(s). If you have selected the twin-engine application, a dual battery switch for each engine is included as standard equipment.



**Caution:** To avoid possible alternator/battery damage on twin-engine installations, make sure that the dual battery switches are never left so both engines are connected together, (i.e., never leave a switch on “BOTH” or “ALL”). Never switch battery positions while the engines are running.

### Alternating and Direct Current Panels (AC/DC Panel)

DC Panel

The AC/DC panel (electrical distribution panel) is located inside the cabin, on the port wall of the main salon. The bottom half of the panel controls your AC accessories and runs off of shore power (standard equipment) or the diesel generator (optional equipment). The top half of the panel controls your DC accessories and runs off of the dealer installed batteries.

AC Panel



### Alternating Current (AC)

Power to your AC accessories is provided either by shore power (standard equipment) or by one of the optional generators. There is a slide mechanism on the AC panel that will need to be positioned either up or down depending upon which power source you select. When using your shore power to provide power to the alternating current system, the slide mechanism needs to be in the down position in order to switch the AC main breaker to the on position. When using your optional generator to provide power to the alternating current system, the slide mechanism needs to be in the up position in order to switch the generator breaker to the on position.



If the Polarity Light (red) comes on, you may have a problem with the shore power cable or your power source. Unplug the shore power immediately and do not use it until a qualified technician corrects this potentially dangerous situation.

The AC volts and the AC amperes gauges allow you to monitor the AC power usage. The system is designed to pull up to 30 amps. If you are pulling more than 30 amps, you should turn off one or more of the breakers for the accessories that you are not using. Pulling more than 30 amps will cause the AC system to trip one or more of the breakers. To avoid tripping breakers, if an accessory is not in use, the breaker should be in the off position. The AC panel provides power to the following:

- Cabin Outlets 1
- Cabin Outlets 2
- Stove
- Battery Charger
- Air Conditioner
- Microwave
- Water Heater (Optional)
- Spare (Optional)

### **Direct Current (DC)**

The 12-volt power system is run off your dealer installed batteries. When selecting DC power, switch the DC main breaker to the on position. The DC panel provides power to the following:

- Cabin Lights
- Fresh Water
- Refrigerator
- Sump Pump
- Head
- Macerator (Optional)
- Spare 1 (Optional)
- Spare 2 (Optional)

Additional DC switches and breakers are located on the console. There is also a DC terminal buss panel located behind the helm. To access this panel, remove the two (2) stainless steel bolts forward of the helm and tilt the helm aft towards the helm seat. The 12-volt direct current provides electrical power for all lighting, pumps, electronics and DC devices.

The DC volt gauge indicates the maximum number of volts that are available at the DC panel. We recommend that you keep an eye on the volt gauge to make sure that you have enough DC volts available to continue operating the DC equipment that you are currently using. Pulling more than the maximum available volts (12 volts) will cause breakers to trip and will turn off your DC accessories.

### **Generator (Gas) 5.0 kw with Carbon Monoxide Detector and Auto Shut Off (Optional)**

If you have selected the optional gas generator, your vessel will come equipped with a remote start/stop for the generator, an hour meter, blower switch and 2 carbon monoxide detectors (one is installed in the V-berth of the main salon and another in the mid berth).

**WARNING:** The switch for the blower is installed next to the AC/DC panel and should be turned on for four (4) minutes prior to starting your engines or the generator to ensure that the bilge is free from any gas fumes. The blower vents are located on the inside wings of the euro transom/dive platform.

The generator is installed in the aft area of the bilge and can be started either direct from the generator or remotely from the AC panel in the cabin.

Before attempting to operate the generator, the boat must be in the water or have some type of water flushing system going into the generator water pick up. The generator seacock is mounted below the port side hatch in the berth of the mid cabin. Inspect the seacock and ensure that it is open and that the hoses are all connected. The seacock is open when the lever is in the vertical position. Then,

- At the remote control panel for the battery management system (installed on the console), press the house battery switch forward to the on position
- Go into the cabin, locate the AC/DC panel and move the generator toggle switch to the on position.
- Locate the blower switch (installed next to the AC/DC panel) and turn it on. After allowing the blower to run for a few minutes and circulate fresh air throughout the bilge, the generator can be started up.

Starting the Generator from the Main Unit - You can start the unit directly from the generator using the manufacturer's instructions below:

**GENERATOR CONTROL PANEL**

**Starting the Generator**

To start the generator, hold the momentary ON switch in the up (on) position, then hold the momentary START/STOP switch in the up (start) position (both switches are held up together). After approximately one second, the starter will engage and the engine will crank. Once the engine is running, the starter will disengage, and the START/STOP switch may then be released to return to its center (run mode) position. Continue holding the ON switch until the engine has sufficient oil pressure, then release it to its center position.

**NOTE:** Should the engine fail to start, release both switches, wait 20 seconds, and try again. Never run the starter more than 20 seconds at a time.

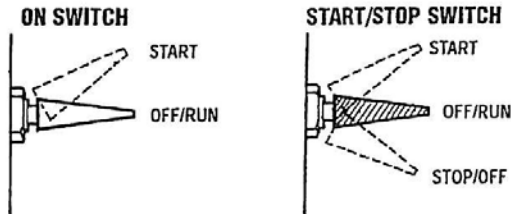

**Starting Under Cold Conditions**

Make certain the lubricating oil conforms with the ratings for the prevailing temperature. Check the table under *ENGINE LUBRICATING OIL*. The battery should be fully charged to minimize voltage drop.

**Stopping the Generator**

To stop the generator, move the momentary START/STOP switch to the down (stop) position then release it to the center (off/run mode) position. This will de-energize the K2 run relay in the generators control panel and stop the generator.

**EMERGENCY STOPPING**

If the generator does not stop using the START/STOP switch, remove the F1 fuse or disconnect the battery.

**CAUTION:** Prolonged cranking intervals without the engine starting can result in the engine exhaust system filling with raw water. This may happen because the pump is pumping raw water through the raw water cooling system during cranking. This raw water can enter the engine's cylinders by way of the exhaust manifold once the exhaust system fills. Prevent this from happening by closing the raw water supply through-hull shutoff, draining the exhaust muffler, and correcting the cause of the excessive engine cranking. Engine damage resulting from raw water entry is not a warrantable issue; the owner/operator should keep this in mind.

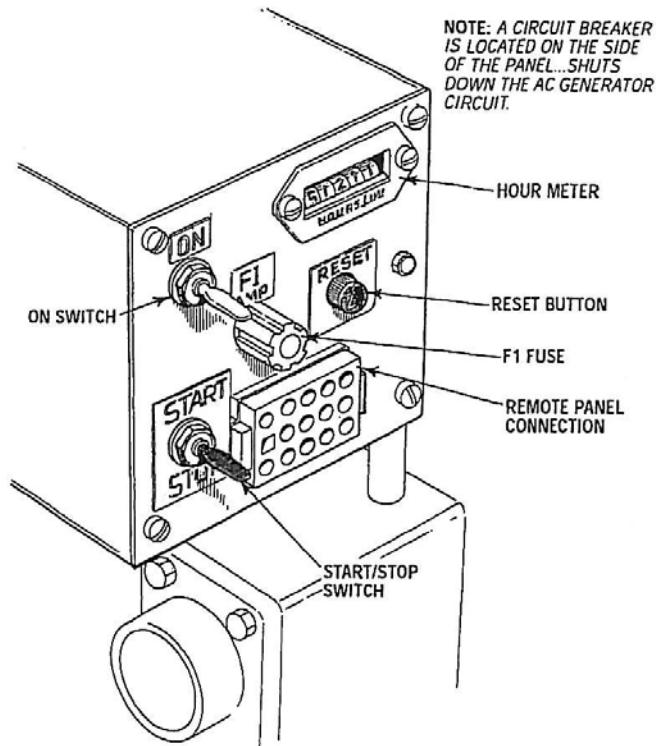

**Abnormal Stop**

An abnormal stop is one in which the generator ceases to run and comes to a stop as a result of an operating fault which may cause damage to the engine, the generator, or create an unsafe operating condition. The fault stop conditions are:

1. Over speed condition.
2. High engine temperature.
3. Low oil pressure.
4. High exhaust temperature.

Should a fault condition occur, the engine will shutdown. On the remote panel, the green LED light will turn off indicating an engine shutdown. Once detected, the fault should be located and corrected (see *ENGINE TROUBLESHOOTING*).

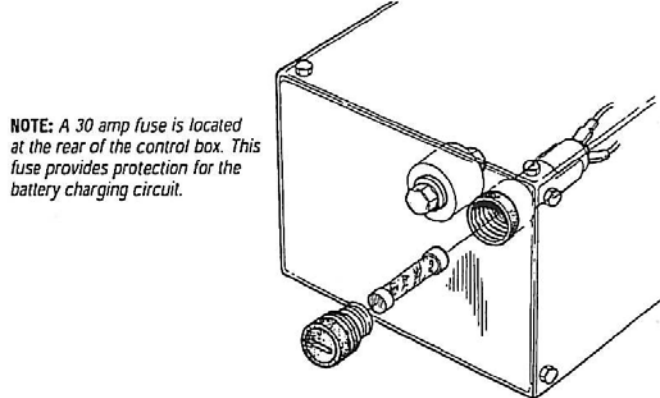

Starting the Generator Remotely from the AC Panel - You can start the unit directly from the generator using the manufacturer's instructions below:

## REMOTE PANEL

### Starting the Generator

To start the generator, hold the momentary ON switch in the up (*on*) position (the green light will come on), then hold the momentary START/STOP switch in the up (*start*) position (both switches are held up together). After approximately one second, the starter will engage and the engine will crank (the green light will dim). Once the engine is running (the green light will brighten), the starter will disengage, and the START/STOP switch may then be released to return to its center (*run mode*) position. Continue holding the ON switch until the engine has sufficient oil pressure, then release it to its center position.

**NOTE:** Should the engine fail to start, release both switches, wait 20 seconds, and try again. Never run the starter more than 20 seconds at a time.



REMOTE PANEL

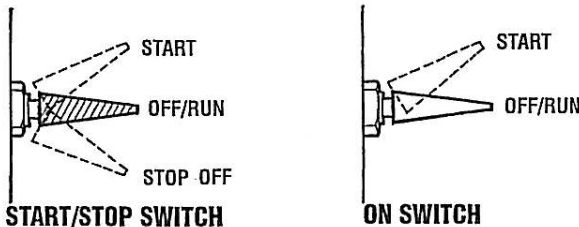

### Stopping the Generator

To stop the generator, move the momentary START/STOP switch to the down (*stop*) position then release it to the center (*off/run mode*) position. This will de-energize the K2 run relay in the generator's control panel and stop the generator.

When you have finished using the generator, be sure to turn off the blower.

Note: The manufacturer of the generator provides the limited warranty for the generator and most associated parts. Please refer to their owner's manual and follow their recommendations for scheduled maintenance and service. To be in accordance with the terms and conditions of their limited warranty, all service and/or warranty repairs must be performed by a repair facility that is authorized to work on their equipment.

Please refer to the owner's manual provided by the manufacturer of the generator for operational procedures and for information related to the care and maintenance of their product. When in doubt, always defer to the generator manufacturer's instructions and/or recommendations.

## Blower

The blower (standard with the optional gas generator) is located inside the bilge and helps keep fresh air circulating in the bilge area. You should periodically check to make sure that the blower is working properly. First, confirm that the blower hoses are connected and the blower itself is secured. Second, locate the blower switch inside the cabin, installed in close proximity to the AC/DC panel, and press the switch to the on position. Then, go back to the bilge area and listen to hear if the blower is running. The exhaust vents are located on the outside of the transom on the port and starboard sides. Check to ensure that air is blowing out of the vents. When finished, go back into the cabin and turn the blower switch off.

Blower



Blower Switch



Blower Exhaust Vent



### Shore Power with Cord

Shore power is used for the operation of AC devices such as your air conditioner, battery charger, and 110 Volt outlets for other appliances. The shore power package includes a 25-foot long yellow shore power cord.

The shore power outlet is located on the port wing, aft of the port light and next to the optional cable outlet. To connect your shore power system:



- Turn the shore power outlet fitting and lift it up.
- Plug the shore power cord into the outlet on the boat.
- Connect the shore power cord to the receptacle at your marina or dock.
- Only then should you switch the AC main breaker to on.
- If the polarity light (red) is on, unplug the shore power (first at the shore outlet, then at the shore power outlet on the boat) and do not use it, until a qualified technician corrects this potentially dangerous situation.

Note: Before attempting to connect to shore power, take precautions to minimize contact arcing by making sure that the AC main breaker switch is in the off position prior to plugging into shore power. The AC main breaker is located on the AC panel on the port aft cabin wall.

Please refer to the owner's manual provided by the manufacturer of the shore power unit for operational procedures and for information related to the care and maintenance of their product. When in doubt, always defer to the shore power manufacturer's instructions and/or recommendations.

## Lighting Systems

### Baitwell Light

The baitwell light switch is located on the switch panel and is labeled baitwell with a light symbol below. To turn on the baitwell light, press the switch forward and open the baitwell lid to see if the baitwell light is on. Press the baitwell light switch to the down or aft position to turn off the baitwell light.

### Bilge Lights

The bilge light switch is located on the switch panel and is labeled bilge with a light symbol on the switch. The 2 bilge lights are installed on the port and starboard stringers. Press the switch forward to turn on the bilge lights. Press the bilge light switch to the down or aft position to turn off the bilge lights.

### Cabin Lights

Cabin lights are installed in the main cabin, the mid berth and the head area. The cabin light switch is located on the AC/DC panel inside the cabin, on the port wall of the main salon. See the section under Electrical System earlier in this chapter for more information on the AC/DC panel.

Switch the DC main and the cabin light switches to the on position to turn on the cabin lights. Each of these lights can then be turned on or off individually. When you are finished using the lights, press the cabin light and DC main switches to the off position.

- Bullet lights (3) are located in the main cabin. Each light can be turned on individually by turning the small switch located on the base of the light.
- A florescent light is located in the head area and can be turned on by pressing the small switch located at the end of the light assembly.
- A dome light is located in the mid berth and can be turned on by flipping the small toggle switch on the base of the light assembly.

### Courtesy Light - Cabin

A small courtesy light is installed at the top of the cabin steps. This light can be turned on at the console by pressing the courtesy light switch in the forward position. The switches on the AC/DC panel do not control this light.



### Cockpit Lights

The cockpit lights are small circular lights located around the forward and aft cockpit area. Locate the 2-way cockpit light switch on the switch panel and press the switch in the forward position to turn on the cockpit lights. Press the cockpit light switch in the aft position to turn the lights off.

### Navigation and Anchor Lights

The navigation and anchor lights are required to be used for operation at night or under low visibility conditions to indicate your position to other boaters. Visually check the operation of your navigation and anchor lights and verify that the lights are free from obstructions. You should check your navigation lights monthly during optimum visibility conditions.

- When you are underway in low visibility conditions, you should have the Nav. Lts. switch in the up or forward position. This will activate the navigation lights, as well as your anchor light.
- When you are anchored or in low visibility conditions, you should turn on the anchor light. Press the Nav. Lts. switch to the down or aft position to turn on the anchor light.

The navigation lights consist of a pair of stainless steel lights that are mounted at the bow of the boat. The red light is installed on the port side and the green light is installed on the starboard side.



If you have selected the optional hard top, the anchor light will be mounted on the center of the fiberglass top. If you have not selected the optional hard top, the anchor light will be mounted on the windshield frame. This light must be secured in the up position when you are underway.



### Underwater Lights (Optional)

A pair of underwater lights can be installed on the hull just below the water line. The lights have LED (light emitting diode) bulbs with a lifespan of approximately 20,000 hours. The lights give off a soft warm light that attracts baitfish, which in turn attracts larger fish. They also provide a little ambiance for those romantic evenings.

A separate light switch panel is installed on the console. Just set the switch in the on position to turn the lights on and set the switch in the off position to turn the lights off.



## Spreader Lights and Courtesy Light (Optional)

The installation of the spreader lights and the dome shaped courtesy light requires the optional hard top. The spreader lights are mounted to the aft side of the hard top frame, along the top edge. The courtesy light is mounted to the bottom of the hard top electronics box.



Two push in switches for the spreader lights and courtesy light are located on the base of the courtesy light.

- To operate the courtesy light - Press the switch labeled courtesy once to turn on the white courtesy light. When you press the same switch a 2<sup>nd</sup> time, the white courtesy light will be turned off and the red courtesy light (for night vision) will turn on. Press the same switch a 3<sup>rd</sup> time to turn off the red courtesy light.
- To operate the spreader lights - The spreader light switch operates in the same manor as the courtesy light but only needs to be pressed in once to be turned on and once again to be turned off.

## Remote Spot Light (Optional)

The installation of the remote spot light requires the optional hard top. The remote spot light is mounted to the forward area of the fiberglass top. To operate the remote spot light, locate the remote spot light panel that is installed on the console.



The switch on the right side of the panel allows you to turn the light on and off. The red LED light located in the center of the panel will be lit when the spot light is turned on. Once the spot light is turned on, the all around toggle lever (on the left side of the panel) can be moved in an up, down, left or right position to rotate the light assembly in the desired direction.

## Air Conditioner with Heater (Optional)

The air conditioner unit is installed under the V berth in the main salon of the cabin and comes equipped with 3 types of vents that are located in the main salon, the mid berth and the head. The air conditioner return is installed on the aft wall of the center V berth storage area. The air conditioner runs off shore power (standard equipment) or the generator (optional equipment), not the battery.

The breaker switch for the air conditioner is located on the AC/DC panel in the cabin. Turn the switch to the on position.



Then, turn on the blower switch, which is located next to the AC/DC panel. Once both switches have been set, go to the air conditioner thermostat control panel. This panel is installed on the port wall of the cabin in close proximity to the AC/DC panel.

Press the on/off button on the air conditioner thermostat panel once to activate the system. Press the fan button to navigate between the various fan speeds. The up (warmer) and down (cooler) arrow buttons allow you to control the temperature which is also displayed at the top of the air conditioner thermostat panel (refer to the

manufacturer's owners manual). The air conditioning thru hull on the side of the boat will be releasing water to ensure that the air conditioner is running cool.

Air conditioner return on face of the V berth storage area



Air conditioning vent in the main salon



Air conditioning vents in the mid berth cabin and head



Blower Switch



Locate one of your air conditioner vents and feel the air flow to see if the air is cooling. Check to make sure raw water is being discharged from the boat via the thru hull. To maintain proper water flow to the air conditioner, check and clean the seawater strainer by unscrewing the bottom clear container.

To turn off the air conditioner, press the on/off button. Once the air conditioner is turned off, you may also turn off the blower switch (if applicable) and the breaker switches for the air conditioner and generator.

On/Off button

Control indicators for A/C, fan and heat

Temperature display

Press to set the fan speed (ranges from 1 to 6)

Press the up or down arrow button to raise or lower the temperature

Air conditioner seacock lever (in photo below) is shown in the closed position

Note: The air conditioner seacock is located inside the cabin beneath the mid berth. This seacock must be in the open position to operate the generator.

The optional air conditioner uses seawater for cooling. The air conditioner seacock is located inside the cabin beneath the mid berth and a strainer is located between the seacock and the cooling (sea water) pump. Do not operate the unit if cooling water is not flowing or the pump will be damaged. If the unit fails to cool, inspect the intake and strainer for blockage. Make sure the seacock is open when in use and closed when not in use.

Raw water pump

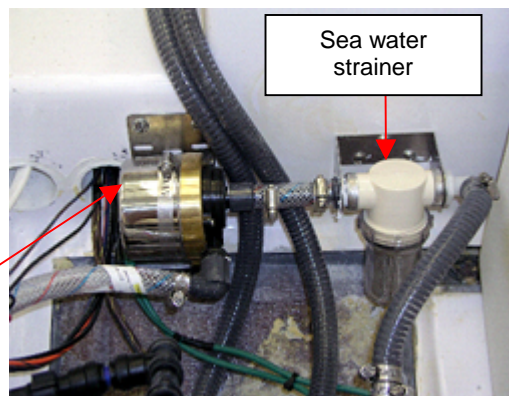

The seawater cooling system may develop an air lock at high speed or if the boat is removed from the water. An air lock will cause cooling water to fail to flow through the system. Open the strainer to purge air from the system and eliminate the air lock. This should be done each time the boat is put in the water.

The following is a typical air conditioner installation. Some installations may vary.

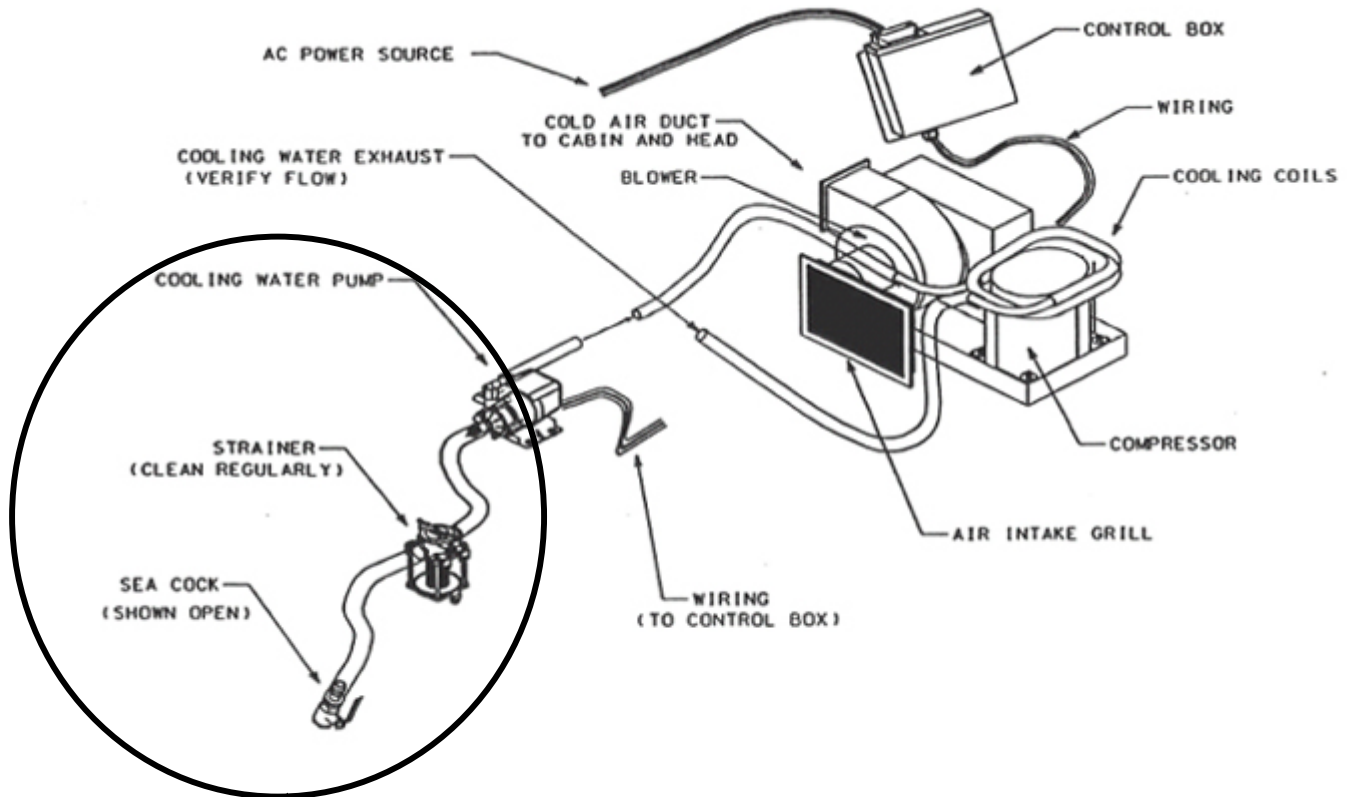

Located under the access panel beneath the mid-berth cushion.

Note: The manufacturer of the air conditioner provides the limited warranty for the air conditioner and most associated parts. Please refer to their owner's manual and follow their recommendations for scheduled maintenance and service. All service and/or warranty repairs **must** be performed by a repair facility that is authorized to work on their equipment.

Please refer to the owner's manual provided by the manufacturer of the air conditioning unit for operational procedures and for information related to the care and maintenance of their product. When in doubt, always defer to the air conditioner manufacturer's instructions and/or recommendations.

## Instrumentation

### Horn - Electric

The horn switch is located on the switch panel and the horn device is located on starboard gunwale just aft of the starboard navigation light.

Depress the horn switch to the up or forward position to activate the horn, then release the horn switch to deactivate the horn. The horn is used to signal, warn or alert other boats or persons on shore. Using different sequences of horn blasts indicates different and sometimes dangerous situations to you or someone around you.



See the Safety section in this manual for more information. Avoid any horn use without an appropriate purpose. Additional information regarding audible warning signals should be covered in a safe boating course.

## Compass

The compass is located on the dash on top of the console. To ensure that the compass light is working properly, press the Nav. lights switch in the forward position to turn on the red LED light inside the compass. When finished, turn the Nav. lights switch back to the middle position.

Please refer to the owner's manual provided by the manufacturer of the compass for operational procedures and for information related to the care and maintenance of their product. When in doubt, always defer to the compass manufacturer's instructions and/or recommendations.



## Full Instrumentation / Gauges (Digital)

All gauges are installed on the console but the configuration and specific location of your gauges will vary depending upon the selection of the various optional engine packages. If your engine package includes analog gauges (i.e., Faria), the gauges will light up when the navigation lights are on. If your engine package includes digital gauges provided by the engine manufacturer (i.e., Mercury SmartCraft, Honda, etc.), the gauges will light up only when the engine is on.

**Note:** For boats rigged with analog gauges (i.e., Faria), the gauge configuration may include individual gauges for temperature, trim, volts and fuel gauges or a multifunction gauge that includes these 4 gauge functions. For boats rigged with digital gauges, the temperature, trim, volts and fuel gauges are incorporated into the tachometer gauge.

**Tachometer** - To ensure the tachometer (tach) is working properly, simply turn the ignition key on and start the engine. While the engine is idling, the tach should be reading in the proper RPM range recommended for the engine. Your engine manual will indicate the appropriate RPM range. When you are running at wide-open throttle, the tach should read near the top end of the recommended RPM range.

If the RPM gauge is reading correctly and the engine throttle settings are correct, the tachometer is operating properly. If the tachometer is not reading correctly, refer to the manual provided by the manufacturer of the gauge (included in your owner's package).

**Speedometer** - To ensure that the speedometer (Speedo) is working properly, get the boat on a planing speed and check to see if the gauge is reading at the approximate running speed at which the boat is traveling.

**Note:** The speed-reading on the Speedo may vary a few mph from the actual speed that the boat is traveling. Either a GPS or a radar gun can check the running speed.

**Trim** - To ensure the trim gauges/indicators are working properly, start by making sure the engine is trimmed all the way down. Locate the trim gauge on the instrument panel and check to see if the level on the trim gauge is in the full down position. As you trim the engine up, watch the trim gauge and ensure that it coincides with the actual trim of the engine. When finished trimming the engine all the way up, the level on the trim gauge should read in the full up position.

**Volts** - To system check the volt gauge, turn the ignition key on and turn on the engine. With the engine running, check the reading on the volt gauge. It should be reading between 12 and 14.5 volts. This reading ensures that the charging system and the volt gauge are working properly.

**Fuel** - The fuel gauge reads the amount of fuel remaining in the tank. To check the fuel gauge, place a known amount of fuel into the fuel fill and fill the tank. Turn the ignition key on and the fuel gauge should read the approximate amount of fuel in the tank.

For example: If the fuel tank holds 200 gallons of fuel and you pumped 50 gallons of fuel into the tank, the fuel gauge should read approximately  $\frac{1}{4}$  of a tank. This ensures that the fuel tank gauge and the fuel sender are working properly.

If the fuel gauge is not reading correctly, we recommend that you have the fuel sender checked by your Pro-Line dealer's Service Department or a qualified professional before considering changing out the gauge. For more information, please refer to the Fuel/Oil Systems section of this manual.

For specific information related to your gauges, refer to the material in your owner's package that was provided by the gauge manufacturer.

## Fuel / Oil Systems

### Fuel Fill and Vent

The fuel fill is a stainless steel fitting labeled "Gas" or "Fuel" and is located approximately amidships on the starboard gunwale. Twist the cap to open the fitting. The cap is connected to the fitting by a chain or cable so that it will not fall into the water and/or get lost. Be careful not to pump fuel into any other fitting on the vessel.

The external fuel fill vent is located just below the fuel fill fitting on the outside of the hull, and the gas tank is vented overboard. While you are filling the tank, fuel entering the tank pushes air in the tank out through the fuel vent.

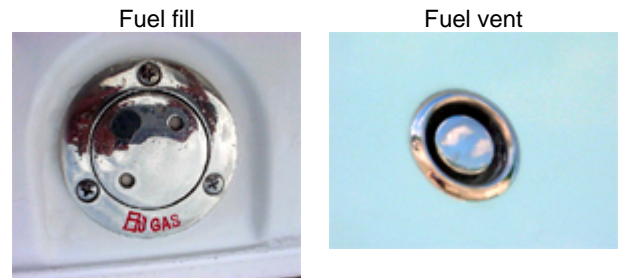

Note: Never pump fuel into any fitting, opening or access port on the boat unless it is labeled "Gas" or "Fuel".

### Fuel Tank

The 200-gallon fuel tank on your Pro-Line is constructed of heavy gauge aluminum with internal baffling to minimize sloshing. The fuel tank is located under the deck and is secured between the stringers and bulkheads.

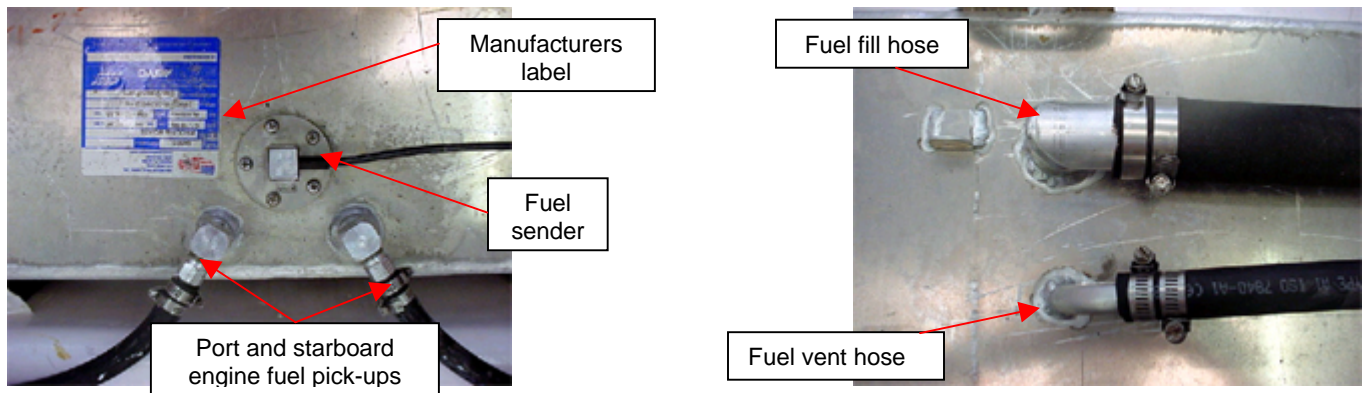

Inspect the hose connections on a regular basis. To access the fuel fill and fuel vent hoses at the tank, go into the mid berth and remove the round access pie located on the right side of the window opening. The other end of these two hoses can be accessed via the deck plate that is installed just below the fuel fill on the inside the cockpit.

### Fuel Sender and Fuel Pick Ups

To access the fuel sender and fuel pick-up, lift the bilge hatch. At the forward edge of the hatch opening, there is a rectangular panel that is held in place with 6 screws. When you remove the panel, you will see the fuel sender and fuel pick-ups.

The fuel sender is equipped with a float that moves up and down with the fuel level in the tank. The fuel level information is sent to the fuel gauge and keeps you informed of the approximate fuel level in the tank. If you feel that your fuel gauge is reading incorrectly, before considering changing the gauge, have your Pro-Line dealer's Service Department or a qualified service professional remove the fuel sender and check to make sure that the float is able to move up and down freely.

### **Fuel Water Separators**

Depending on your selection of the various optional engine packages, your boat may be equipped with a fuel water separator for each engine. However, some engines come equipped with a built in fuel water separator. Please refer to the owner's manual provided by the manufacturer of your engine package for operational procedures and for information related to the care and maintenance of their product. When in doubt, always defer to the engine manufacturer's instructions and/or recommendations.

If your engine package requires the installation of fuel water separators, they will be mounted in the bilge on the inside of the port and starboard stringers. There is one unit for each motor. The "spin on" filter cartridges should be renewed every season at a minimum. Fuel tanks that are not kept full accumulate water faster due to condensation. Therefore, the filter cartridges may need to be replaced more often depending upon usage and conditions or if motors begin to run rough. If water should somehow enter your fuel tank via condensation, your fuel source, etc., it will become trapped in the fuel water separator before it is able to travel through the fuel system and to your engine. When replacing the filter cartridges for the fuel water separators, coat the rubber seal with a film of grease or oil to help prevent sticking.

Please refer to the owner's manual provided by your engine manufacturer for proper procedures. Some engines will not have a separate fuel water separator located in the bilge. Instead it will be located on the engine itself. Check engine specs.

If you have selected the optional air conditioner system, a designated fuel water separator will be installed on the inside of the port stringer specifically for this optional installation.

### **Primer Bulbs**

Depending on your selection of the various optional engine packages, your boat may be equipped with primer bulbs. If required, a primer bulb will be installed for each engine. Primer bulbs are used to prime the fuel pump in the motor with fuel. Squeeze the primer bulb a few times until resistance is felt. If no resistance develops and the fuel pump will not prime, you may be out of fuel, the primer bulb may be defective, or a leak may have developed allowing air into the system. Primer bulbs (if applicable) are located with the rigging tubes where they exit the bilge and are easy to get to by standing on the dive platform.

Note: Not all engines require primer bulbs. Refer to the engine manual for verification.

### **Oil Tank and Fill**

Depending on your selection of the various optional engine packages (i.e., oil injected outboard engines), your boat may be equipped with remote oil tanks. If your engine package requires the installation of an oil tank, it will be mounted in the bilge beneath the transom sink and can be accessed by removing the battery switch panel. The oil fill will be installed on the port gunwale in close proximity to the transom sink.

Make sure that the oil tanks are well stocked with the type of engine oil that is recommended by your engine manufacturer for your engines; refer to your engine manual. It is imperative that the oil supply remains clean and uncontaminated by water or dirt. Check to make sure the oil lines are free from leaks, kinks and chafing. Some motors use a primer bulb to initiate oil flow. Air may periodically enter the system and require purging. Refer to your engine manual for specific instructions.



If your optional engine package requires the installation of remote oil tanks, please refer to the owner's manual provided by the engine manufacturer for operational procedures and for information related to the care and

maintenance of their product. When in doubt, always defer to the engine manufacturer's instructions and/or recommendations.

### Fuel / Oil Leaks

The fuel tank is vented overboard and the vent should be inspected for obstructions regularly. Ensure all of the fuel hoses remain properly secured and located according to NMMA standards. Inspect all hose clamps and fittings to ensure they are double clamped where needed and that there are no fuel leaks in any of the hoses. Also, inspect the oil system, if applicable, and ensure that the oil tank and hoses remain properly connected and secured.

If you notice a fuel odor or see fuel in the bilge, there may be a leak somewhere in the fuel system. Correct any fuel leaks before operating the vessel.

**Caution: If at all possible**, any fuel tank and or fuel system repair should be handled by your Pro-Line dealer's Service Department or by another qualified service professional.

## Sea Water System

### Baitwell Pump

The baitwell switch at the helm controls the baitwell pump (1100 gph), which is mounted on a seacock in the bilge area. The baitwell pump and seacock are accessible through the bilge hatch. Raw water for the baitwell tub comes through the seacock, to the baitwell pump and then to the baitwell tub. The hose on the lower port feeds raw water to the washdown pump.

Before turning the pump on from the helm, check to be sure that the seacock is open. The seacock is wide open when the yellow seacock lever is vertical as shown in the photo to the right. When the yellow seacock lever is horizontal, the seacock is closed. The seacock should remain closed when the baitwell pump is not in use.



To operate the baitwell pump, locate the baitwell switch on the console and press the switch to the forward position to turn on the pump. When the baitwell pump is operating, go to the baitwell tub, open the baitwell lid and visually check to see if water is pumping into the tub through the aerator fitting. To turn the baitwell pump off, press the baitwell switch to the aft position. You should always turn the baitwell switch off at the helm if the pump is not going to be used soon.



The 35 gallon capacity baitwell tub is located aft of the helm seat. It comes equipped with an aerator head, 2 overflow drains that allow circulation to keep bait alive, a plug for the drain and a baitwell light. The bait station is also equipped with a clear lid, drink holder, bar soap holder, knife and pliers holder, and a grab rail.

If you find it necessary to run the baitwell pump while you are underway, you may be forcing more water than necessary up through the seacock. In this instance, adjust the seacock lever to a 45 degree angle so that the seacock is only halfway open. The seacock lever may require additional adjustments to find a setting that works best for you.

Even when the baitwell pump is turned off, if the seacock is open, the baitwell tub will continue to fill with water while you are underway.

**Note:** Boats that are equipped with an optional generator and/or air conditioner will have additional brass seacocks and a strainer installed in the aft (generator) and amidships (air conditioner) bilges to filter seawater. These seacocks should be closed when the generator and/or air conditioner are not in use.

## Washdown Pump and Raw Water Washdown

The washdown pump is mounted on the starboard aft stringer and is equipped with a pressure switch. This pump shares the same seacock with the baitwell pump and is accessible via the bilge hatch. The washdown fitting is mounted in the starboard aft corner of the cockpit. Just attach a garden hose to the fitting and the washdown system is ready for use.



To turn on the washdown pump, locate the washdown switch on the instrument panel and press the switch to the forward position. If you do not feel pressure after pressing the washdown pump switch, the seacock may not be open. Verify that the seacock is open and depress the switch again. When not in use, the washdown switch should be left in the off (down or aft) position. The round filter attached to the side of the washdown pump should be removed and cleaned often with running water.

Note: Before operating the washdown pump, make sure that the seacock at the baitwell pump is in the open position before turning on the pump. The seacock is wide open when the seacock lever is in the vertical position. When the seacock lever is in the horizontal position, the seacock is closed. The seacock should remain closed when the baitwell or washdown pumps are not in use.

## Bilge Pumps

The boat is equipped with three (3) bilge pumps that are installed as standard equipment. Since there are 3 bilge pumps, there are 3 bilge pump switches to choose from on the switch panel. The locations of the 3 bilge pumps and the labeling of the bilge pump switches are as follows:

- Bilge 1 - This 1100 gph bilge pump is located in the aft bilge. If your vessel is equipped with an optional generator, this pump will be located just forward of the generator.
- Bilge 2 - This 1500 gph bilge pump is your high water bilge pump. This pump is located just aft of the 1100 gph bilge pump.
- Fwd Bilge - This 1100 gph bilge pump can be accessed via the panel under the mattress in the mid berth.

There are 2 steps in properly checking the bilge pumps. First, turn on one of the bilge pumps at the instrument panel by pressing the applicable bilge pump switch to the on or forward position. This action should illuminate the light on the switch. To check and see if the bilge pump is operating, open the hatch over the applicable bilge pump and listen to hear the bilge pump running.

Second, turn the bilge pump off at the instrument panel and check the bilge pump float switch. Each pump is equipped with an automatic float switch (white box) that is mounted next to or in close proximity to the bilge pump. As long as your boat is equipped with an operable battery, each pump will operate independently when water is present in the area. Each float switch is equipped with two plastic knobs located on either side of the switch. Turn either one of the knobs to raise the float to engage the bilge pump. If the pump comes on, the automatic float is operating properly. It is recommended that you check the operation of each automatic float switch monthly.

Bilge Pump 2 is a high water bilge pump. The float switch for this pump is located aft of the port battery trays. The high water alarm panel is installed on the console.

If for some reason the indicator light on your bilge pump switch comes on, check your bilge for water. It is not uncommon for rain water or water from washing your boat to accumulate in the bilge. Standing water will activate the automatic float that is connected to the bilge pump. If you notice your pump running frequently during your day on the water, you should check the thru hull fittings, hose connections, etc. for any possible leaks.

Keep the bilge area clean and free from debris that could clog ports or inhibit float movement. Also, keep the battery (starboard) that provides power to the bilge pumps charged. If the battery is not charged and flooding occurs, the boat could swamp causing damage and possible loss of life or property.



Bilge pump 2  
(high water pump)  
  
Float switch is  
mounted aft of the  
port battery tray

Forward bilge  
pump with  
float switch

Bilge pump 1 with  
float switch

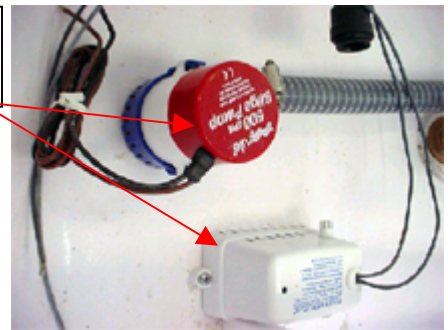

### Fish Boxes with Macerator Pumps

Your boat is equipped with port and starboard fish boxes with a total capacity of 125 gallons. Two macerator pumps drain the fish boxes and/or macerate any fish particles. The pumps are mounted to the outside of the port and starboard aft stringers. They are easily accessible via the hatches installed on the dive platform.

As the fish boxes drain, water and/or debris travels to the pump where any debris is macerated and then pumped overboard.



The fish box macerator pumps operate on a 3-position rocker switch located on the switch panel labeled fishbox. To properly operate the fish box macerator pump, fill one of the fish boxes with water. Then, press the fishbox switch forward or down to turn on the applicable fish box pump. The water and fish particles will be pumped out of the tub and will be routed through the macerator pump and then overboard via the applicable fish box thru hull on the side of the boat. When you are finished emptying the fish box, place the fish box switch in the center position to turn off the fish box macerator pump. Repeat this process for the other fish box.

### Fresh Water System

Note: There must be fresh water in the fresh water tank in order for the fresh water and shower sump pumps to operate. Operating the pumps with an empty tank could cause serious damage to the pumps.

#### Fresh Water Stations

The boat is equipped with 3 fresh water stations: (1) main cabin sink in the galley, (2) head sink and/or shower and (3) transom sink. Turn on the fresh water switch located on the AC/DC panel to blow out any air that may be trapped in the water lines. When you turn on any of the faucets, you will hear the pump run.

- Fresh Water Faucet in Main Cabin (Hot and Cold) - The fresh water faucet for the main cabin is located at the galley sink.
- Fresh Water Faucet with Pull Out Shower in Head (Hot and Cold) - The fresh water faucet with pull out shower is located at the head sink. When doubling as a showerhead, pull the faucet/nozzle from the sink and place it in the fitting on the forward head wall.
- Fresh Water Faucet at Transom Sink (Cold) - The fresh water system hose is located in the transom sink behind a white rubber cap/cover. Pull open the cap and pull out the faucet/shower nozzle and hose. Press the button on the nozzle to ensure proper operation (water spraying). When you are finished, stow away the transom fresh water hose and cover the outlet with the white rubber cap.



Note: See the section titled Fresh Water Pump for operating instructions before using any of the fresh water stations.

## Fresh Water Pump

The 5.0 fresh water pump is accessible via the hatch under the mattress in the mid berth. Locate the fresh water pump switch (labeled fresh water) and the DC main switch on the AC/DC panel and move both switches to the on position. Next go into the head area and turn on the sink faucet/nozzle to verify that water is coming out of the faucet/nozzle. Then, turn off the head sink faucet/nozzle and repeat the same process for the faucet/nozzle at the cabin sink in the galley.

Fresh water pump and filter

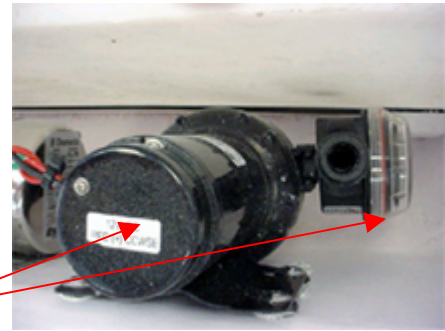

If the fresh water system is not in going to be in use, return to the AC/DC panel in the cabin and turn the cabin water system switch to the off position.

Note: If you should hear a sucking sound, you may have a leak on the inlet side of the fresh water tank. The tank can be accessed via the panel located under the mattress in the mid berth. There are 2 hoses connected to the front of the tank. The larger diameter hose is the water fill hose and the smaller diameter hose is the water vent hose. Inspect the hoses for leaks and make certain that the hose connections are secure.

When you close all of the faucets, the pump will run briefly. If the pump continues to run with all faucets closed, check the system for leaks or have the pump tested.

## City Water Hook-Up / Inlet

This fitting is located on the outside of the transom on the port side. Twist the cap to open the fitting and then connect to your marina's water supply outlet. Fill the fresh water system with **potable** water only.

## Fresh Water Tank Fill

This is a stainless steel fitting located amidships on the port gunwale. Twist the cap to open the fitting. The cap is connected to the fitting by a chain or cable so that it will not fall into the water and/or get lost. Use a garden hose to fill the fresh water tank through this fitting. Fill the tank with **potable** water only.

## Fresh Water Tank

The 39 gallon capacity fresh water tank can be filled via the stainless steel fresh water tank fill located on the amidships port gunwale or via the city water hook-up/inlet on the outside of the transom. See the Fresh Water Tank Fill and/or the City Water Hook-Up/Inlet sections for filling procedures.

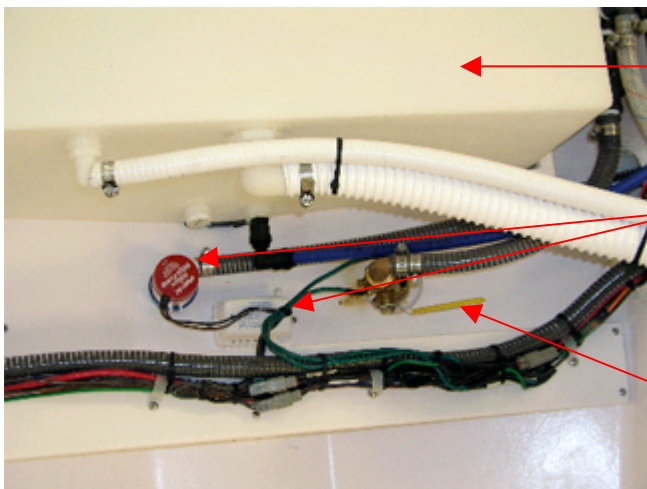

39-Gallon fresh water tank

Forward bilge pump and automatic float switch

Air conditioner seacock

The fresh water tank can be accessed via the hatch located under the mattress in the mid-berth. The fresh water pump (not shown in this photo) is located on the port side of the fresh water tank.

Important: Fill the tank with potable water only. Refilling the tank often will help to keep it a source of clean fresh drinking water. Never fill the fresh water tank with anything other than fresh water.

### **Water Heater (Optional)**

The optional 6-gallon capacity water heater is located in the cabin behind the galley area. It is best accessible by removing the refrigerator.

To operate the water heater, locate the water heater and the AC main switches on the AC/DC panel and turn them both to the on position. Allow the water heater pump to operate for a couple of minutes then turn on the hot water faucet either in the galley or in the head to check the water temperature. When finished, turn off all the water faucets along with the water heater and DC main switches on the AC/DC panel.



### **Shower System and Shower Sump Pump**

The shower sump pump is used to pump out any gray water (used water) from the system. The pump is located inside the cabin and is accessible through the mid-berth access hatch under the mattress. Water from the sink and floor drains, in the head area, is pumped out via this system. Under normal operations, as water drains through the sink and shower drains, the float switch activates the pump and allows the gray/used water to be pumped overboard.

To operate the shower system and the sump pump, go to the AC/DC panel in the cabin, locate the DC main, sump pump and fresh water switches and move them all to the on position. Visually inspect the sump pump to ensure it is properly secured and listen to hear the pump running. When you have finished using the sump pump system, turn all switches (DC main, sump pump and fresh water) back to the off position

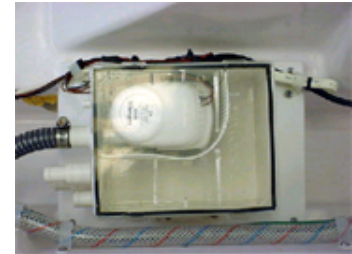

## **Head Waste System**

**WHAT IS THE LAW?** Congress enacted the Clean Water Act of 1972 (amended in 1987). This law addresses a wide spectrum of water pollution problems, including marine sewage from boats in navigable U.S. waters including coastal waters up to three miles offshore. The law further provides for "no discharge" by boats operated in enclosed lakes and reservoirs or in rivers not capable of interstate navigation. States may apply to the EPA to have certain other waters declared "no discharge zones" if discharge of treated sewage would be harmful. In short, boats with installed toilets must have an operable Coast Guard approved Marine Sanitation Device (MSD) designed to either hold sewage for pump out ashore or for discharge in the ocean beyond the three mile limit, or to treat the sewage to Federal standards prior to discharge.

All boats built since 1977 with installed toilets must have an operable approved type I, II or III MSD. Since 1980, all boats (including those built before 1977) with installed toilets must have an operable MSD. Both the U.S. Coast Guard and the Natural Resources Police can enforce MSD requirements.

Check with your local authorities, Coast Guard, local marina or your dealer for the rules and/or laws that may apply specifically in your area.

### **Dockside Discharge Waste Outlet**

This stainless steel fitting labeled waste is located amidships on the port gunwale. Twist the cap to open the fitting and connect to your marina's dockside service facilities.

### **Vacuum Flush Head System with Holding Tank**

Your Pro-Line is equipped with a VacuFlush head system and dockside discharge. The overboard discharge system is available as an optional installation.

Note: There must be fresh water in the fresh water holding tank in order for the head macerator pump to operate and properly flush the system. Operating the pump with an empty tank could cause serious damage to the pump.



To operate or test the VacuFlush head system, make sure that your fresh water tank is full of water. Make sure that the DC main, fresh water, and head switches on the AC/DC panel are all in the on position. To flush the VacuFlush head system, use your foot to depress the pedal at the base of the head. This action will pump fresh water into the stool, empty the head and transfer all waste into the waste tank. When you release the pedal, water will stop entering the stool and the flushing action will cease.

Dockside Discharge – When at a marina that offers dockside discharge, the marina will provide the facilities needed to perform this operation. You will not need to use the Tank Watch system (optional equipment with overboard discharge). The stainless steel fitting labeled waste is located amidships on the port gunwale. Twist the cap to open the fitting and insert the hose provided by the marina into the dockside discharge waste outlet to connect to your marina’s dockside discharge service facilities. Follow the instructions provided by the marina to operate their equipment.

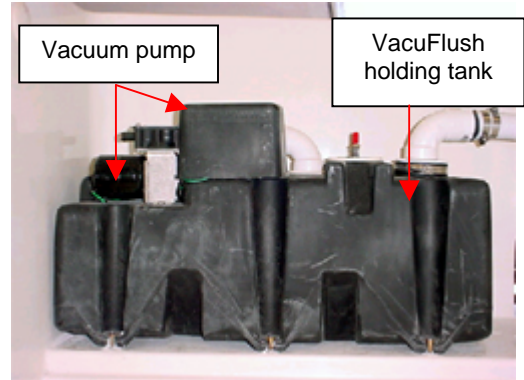

**Overboard Discharge (Optional)**

If you have selected this optional system, your boat is equipped to offer you the option of using either dockside or overboard discharge to pump out the waste tank. Before using the overboard discharge system, be sure to check with your local authorities, Coast Guard, local marina or your dealer for the rules and/or laws that may apply specifically in your area.

You can check the waste level in the waste tank by monitoring the lights on the Tank Watch 4 panel, which is located in the head area. As waste enters the tank, the lights will change to indicate the waste level (i.e., green for empty, yellow for low, orange for mid level or red for full).

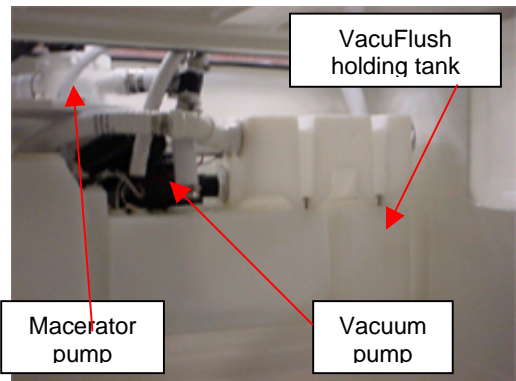

To operate the overboard discharge system, first make sure that the DC main, fresh water, macerator and head switches on the AC/DC panel are all in the on position. Then, turn the key on the Tank Master 4 panel to the automatic position. The green light will come on indicating that the system is working and waste will begin pumping overboard via one of the thru hulls located amidships on the side of the hull.



Once the tank level reaches the low level in the tank, the green light will go out and the system will turn off. You will need to turn the key to the manual position to complete the pump out process.

If the system does not seem to be pumping properly (water should shoot out approx. 10 feet via the thru hull), check for leaks, loose clamps, etc. Remove the starboard wall panel in the mid berth cabin to access the holding tank. Then, check the hose connection to be sure that there is no leak.

Refer to the manual in your owner's packet supplied by the manufacturer of the VacuFlush system for specific operating instructions.

Warning: Waste in the holding tank can form methane, an explosive gas. Use suitable precautions when any maintenance is done to the sanitary system.

**Cabin Appliances and Accessories**

As standard equipment, your galley comes equipped with a direct current refrigerator and an alcohol/electric stove. The following optional equipment is also available for installation in the main cabin:

- Microwave
- Stereo - AM/FM CD with 4 speakers and remote
- Stereo - AM/FM CD with upgraded (4) speakers, woofer and amplifier
- Stereo - XM upgrade
- Television (flat screen) with DVD player and cable outlet
- Cabin floor – Teak and holly
- Cabin floor – Woodgrain (laminated)

Please refer to the owner's manuals provided by the manufacturers of the components listed in this section for operational procedures and for information related to the care and maintenance of their products. When in doubt, always defer to the component manufacturer's instructions and/or recommendations.

Note: The individual manufacturers of most of the optional products listed in this section provide the limited warranties for their equipment and most associated parts. These manufacturers provide recommendations regarding service and warranty related issues. In many cases, service and/or warranty repairs **must** be performed by a repair facility that is authorized to work on their equipment.

### Alcohol / Electric Stove

Before attempting to use the alcohol/electric stove, please refer to the owner's manual provided by the manufacturer of the stove for operational procedures and information related to the care and maintenance of their product. When in doubt, always defer to stove manufacturer's instructions and/or recommendations.

Do Not attempt to cook on top of the glass lid.

Do Not close the glass lid until the stove has cooled completely.

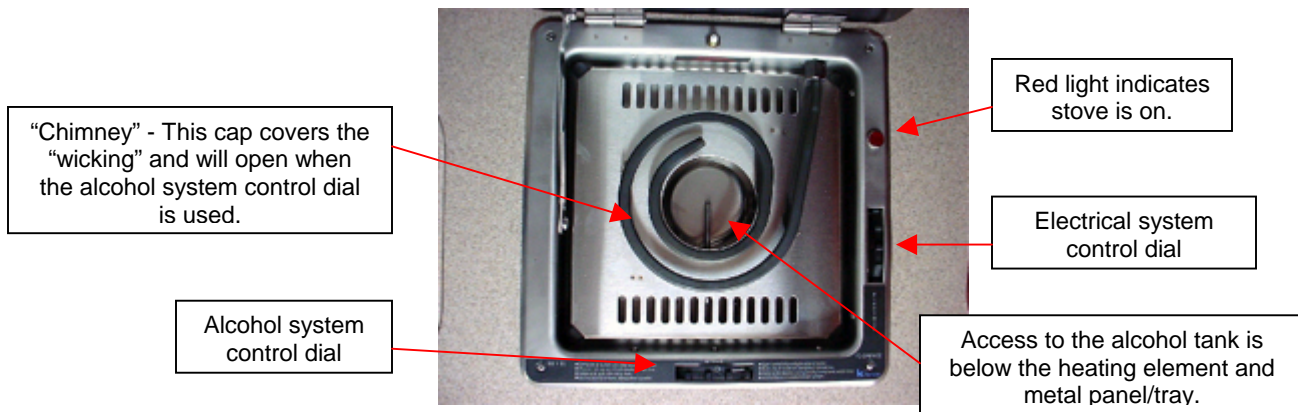

#### To Operate the Stove Using the Electrical System

- Locate the stove switch and AC main switch on the AC/DC panel in the cabin and turn both of these switches to the on position.
- Locate the stove dial on the side of the stove and rotate the dial to the desired heating level. The red led light will come on indicating that the stove is working.
- When finished, rotate the dial back to "O" to turn the stove off.

#### To Operate the Stove Using the Alcohol System

- Lift and rotate the heating element to the right until it is in a vertical position.
- Remove the metal panel/tray that is installed under the heating element.
- Turn the quarter size metal knob on the top of the stove counter clockwise to access the alcohol tank.
- Add a maximum of 6 ounces of fuel; just enough to cover the wicking. Use alcohol stove fuel only (denatured ethyl alcohol).
- Replace the quarter size metal knob turning it clockwise.
- Replace the metal panel/tray.
- Rotate and lower the heating element and press to snap it back into place.

- Locate the alcohol dial on the front of the stove and turn it to the left to its highest setting. This also opens the chimney in the center of the stove.
- Apply a match or lighter to the chimney to light the stove. Then, adjust the dial to the desired setting.
- When finished, rotate the dial to the right (back to “O”) to turn the stove off.

### Refrigerator

The DC refrigerator, located in the galley, has a latch on the left side of the door that secures the door when it is closed. To open the refrigerator door, slide the latch to the left. When the door is closed, slide the latch back to the right to hold the door securely in place.

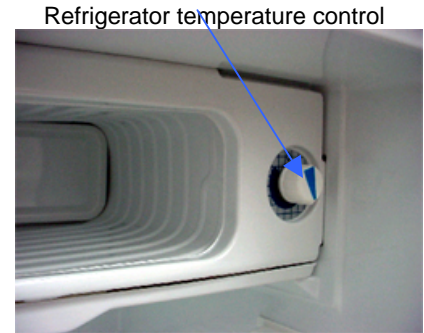

### Microwave (Optional)

Please refer to the owner’s manual provided by the manufacturer of the microwave for operational procedures and for information related to the care and maintenance of their product. When in doubt, always defer to the microwave manufacturer’s instructions and/or recommendations.

Note: The microwave receptacle is located behind the refrigerator.

### AM/FM Stereo with CD Player, Speakers and Remote (Optional)

The AM/FM stereo comes equipped with a CD player, remote and 4 speakers. The stereo can be operated from within the cabin or remotely from the console and is powered by the dealer-installed batteries. The installation locations are as follows:



- AM/FM Stereo with CD player – Installed on the galley wall
- Remote - On the console
- Speakers - Two speakers at the forward V berth and two in the cockpit.
  - If you have selected the optional hard top, the cockpit speakers will be installed on the face of the built in storage box.
  - If you have not selected the optional hard top, the cockpit speakers will be installed in the aft cockpit but the installation location will vary depending upon which additional optional accessories you may have selected.

Based upon availability from our vendors, stereo equipment changes from time to time. Therefore, we request that you refer to the owner’s manual provided by the manufacturer of the stereo equipment for operational procedures and for information related to the care and maintenance of their product.

### XM Stereo Upgrade (Optional)

The controller head unit (XM box) is located behind the AC/DC panel in the cabin. When activating your satellite service, your service provider will request that you provide them with the radio ID #. You will find this 8 character ID # (alpha numeric) on the face of the XM box.

Based upon availability from our vendors, this equipment changes from time to time. Therefore, we request that you refer to the owner’s manual provided by the manufacturer of the XM unit for operational procedures and for information related to the care and maintenance of their product.

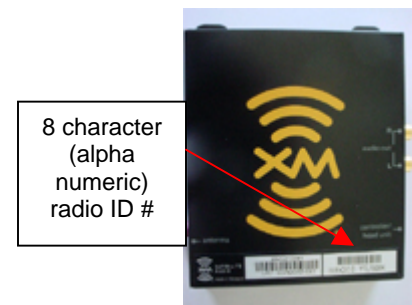

### Upgraded Stereo Package (Optional)

This upgraded stereo package adds the following electronics to the optional AM/FM stereo with CD player and remote: upgraded speakers, woofer and amplifier. This package also includes the upgraded satellite box shown at the right. This equipment is installed on the aft wall of the mid cabin.



### Flat Screen Television with DVD Player and Cable Outlet (Optional)



The combined flat screen television and DVD player is mounted over the V berth on the forward cabin wall. When this option is factory installed, a cable outlet is also included and is installed next to the outlet for shore power. Twist the cap on the fitting and lift the cap to gain access to the outlet. Then, plug the cable source from shore into the outlet.

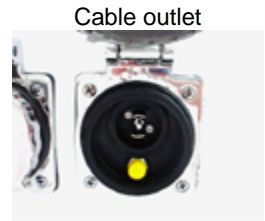

Please refer to the owner's manual provided by the manufacturer of the television for operational procedures and for information related to the care and maintenance of their product. When in doubt, always defer to the television manufacturer's instructions and/or recommendations.

## Windows, Storage, Hatches and Doors

### Windshield - Tempered Glass with Vent

The windshield assembly is constructed of white powder coated aluminum and tempered glass. The windshield vent in the center of the windshield assembly can be opened and closed manually to allow air circulation at the helm.

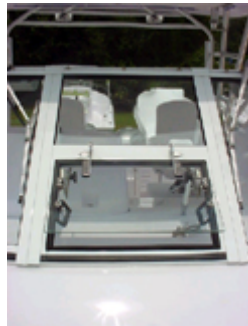

To open the windshield vent, turn the 2 black latches to release the vent window. Then, loosen the 2 black knobs, open the vent window to the desired position and secure the knobs to hold the vent window in place. Just reverse the process to close the vent window.

### Windshield Wipers – Port and Starboard Side

A 3-position switch controls the port and starboard wipers. Depressing the wiper switch on the console in the up or forward position activates the starboard wiper. Depressing the switch to the down or aft position will activate both the port and starboard wipers. The center position on the switch is the off position for both wipers. If at all possible you should never operate the wipers on a dry windshield. This will dramatically reduce the life of your wiper blades.

## Windows

To allow for proper ventilation, 3 styles of windows have been installed throughout the cabin.

Cabin Hatches - A cabin hatch complete with screen is installed in the ceiling of the main cabin. To open the window, remove the screen, turn both levers forward and push the hatch open to the desired position. To hold the hatch in place, tighten the black plastic cylinders on both of the mounting arms. Then replace the screen. DO NOT allow passengers to sit or stand on the hatch as they could break the hatch. The hatch should be in the closed and latched position when the vessel is underway.

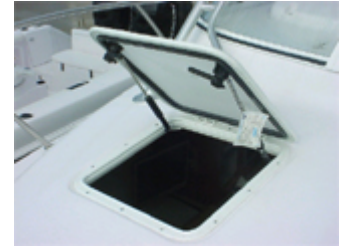

Mid Cabin Window with Screen - A window is installed in the mid berth cabin and is hinged at the top. To open the window, turn the latches to the horizontal position and lift the window open. To close the window, rotate the hinged window back into the closed position and turn the latches back to the vertical position to secure the window.



Cabin Portholes - Two portholes complete with screens are installed in the main cabin; one in the galley and one in the head area. To open the porthole window, loosen the 3 star nuts by turning them in a counter clockwise direction. Then, rotate each of the star nuts down and away from the plastic window; the window is hinged at the top. Once the star nuts are out of the way, lift the window open and away from the frame by carefully pulling on the phalanges at the bottom of the window. When finished, close the window, rotate each of the star nuts back into place and turn the star nuts in a clockwise direction to secure the window.

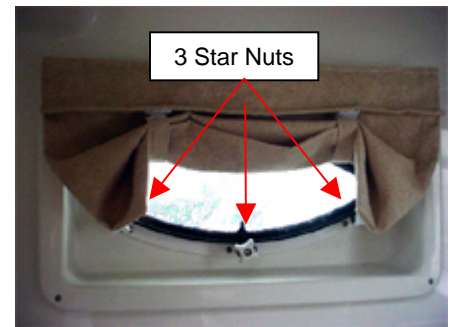

## Storage

Your boats come with plenty of storage areas:

- Drink holders
- Below the Forward V berth
- Tub below the rear facing aft jump seat
- Cabinets, storage compartments and shelves are located throughout the cabin

Rod Holder Storage - In addition to the rod holders installed on the optional hard top frame, the following rod holder storage is available:

- Rod Holders with Inserts - Two pair of flush mounted stainless steel rod holders with PVC inserts to protect your rods
- Rod Racks - A pair of rod racks is installed in the port and starboard freeboard of the aft cockpit. Combined, they can accommodate up to 4 fishing rods.
- Vertical rod holders (4) on the optional hard top frame

Fire Extinguisher Holder – This boat comes equipped with a fire extinguisher holder installed on the starboard side of the steps located inside the cabin.

Tackle Box - The tackle box is located in the cockpit behind the aft facing jump seat. The box is equipped with 4 trays for storing your small fishing tackle equipment.

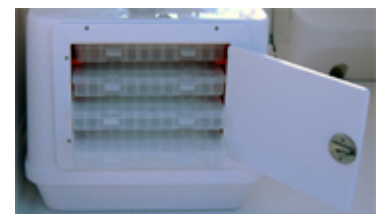

## Hatches and Latches

**Deck Hatches** - The fiberglass deck hatches for the anchor locker, bilge and the 2 fish boxes can easily withstand the weight of passengers and gear; just like the rest of the deck surfaces. The hatches for the bilge and fish boxes are each equipped with gas shocks. The gas shocks allow you to easily open and close the hatches. The gas shocks also hold the hatches in place when they are open.

The twist latches that are installed on the fiberglass deck hatches are made of stainless steel. Just lift the handle of the latch from the recessed area of the hatch, twist it and lift the hatch open. Make sure that all hatches are closed and secured before you get underway. Lift the handle of the latch, turn it 180 degrees so that the latch catches and return the handle to the recessed area of the hatch.

**Access Hatches** - The following photo identifies the locations of the components that can be accessed via the access hatches.

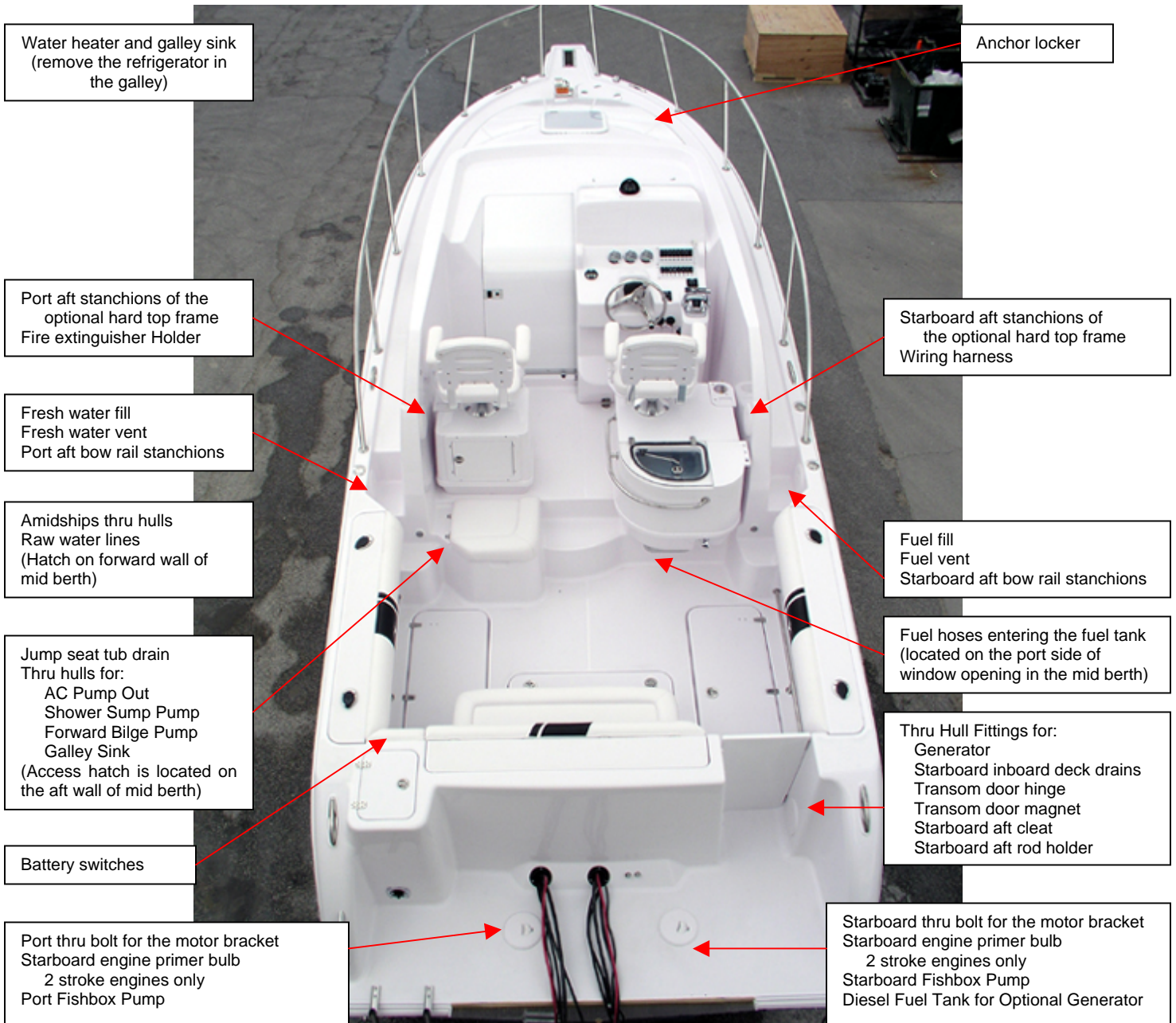

## Transom Door

The transom door is located on the starboard aft corner of the boat. The sliding bolt style latch secures the door in the closed position. To open the door, slide the latch starboard (to the left from inside the cockpit).

The transom door should always remain closed while underway. When the boat is anchored, the transom door can be held open by the magnetic locking mechanism mounted on the starboard aft freeboard. To close the door, pull the door firmly to release the magnet and move the door to the closed position. The door latch will automatically engage. See the Service and Care section of this manual for cleaning recommendations.



## Cabin Door / Companionway Door

The acrylic cabin door is equipped with a locking latch, doorstop and a slide mechanism. To open the door, just press the latch on the latch assembly to the right and slide the cabin door to the starboard side. To close the door, slide the door back to the port side and the latch will engage itself.

The stainless steel doorstop at the bottom of the doorframe can be utilized to keep the door from sliding shut when you are anchored. When using the doorstop, take notice of the prevailing seas. The door should never remain open when you are underway or when conditions might cause a passenger to lose their balance and accidentally fall through the doorway.

The lock comes with a set of two numbered keys. We recommend that you make note of the key number and keep it in a safe place. In the event that you need to replace the keys, you will not need to replace the entire lock assembly. See the Service and Care section of this manual for cleaning recommendations.

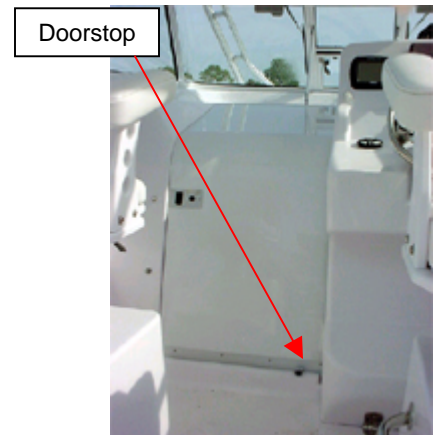

## Hardware

### Cleats

Your boat is equipped with 7 cleats that are installed to provide areas to permit you to tie off the boat at dockside, tie off to another boat that is anchored, secure bumpers/fenders, and/or tie off the anchor (when dropped) to prevent the line from pulling on the optional windlass, etc. You should never use the cleats for towing another boat or skier.

### Bow Pulpit with Anchor Roller and Rope Locker Storage

We have installed an aluminum anchor roller with built in bow protector at the bow pulpit. If you have selected the optional windlass, the anchor line will be secured inside the anchor locker and then routed through the windlass and anchor roller. The anchor (not included as standard equipment) can be held on the line beneath the bow pulpit. This allows you to move about the bow area safely without tripping over the line or anchor.

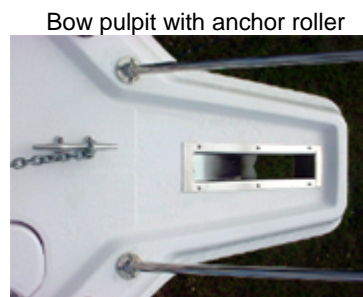

Bow pulpit with anchor roller

Rope locker storage and optional Windlass



### Bow Rail

The bow rail is constructed of stainless steel. The railing, which is through bolted to the gunwale, is provided for safety. Never use the bow rail to tie off to anything heavier than a bumper/fender. Do not use the bow rail for anchoring, or to tie off to the dock or another boat. Do not use the bow rail to tow another boat or skier. Never

stand on the bow rail or use it as leverage when pulling up an anchor, a fish or any other objects. Do not use the bow rail to tie off and/or secure a large catch, etc.

**Thru Hull Fittings**

Thru hull fittings provide overboard drainage. The following photos indicate the source of drainage for each of the thru hulls:

**Port Side**



**Starboard Side**

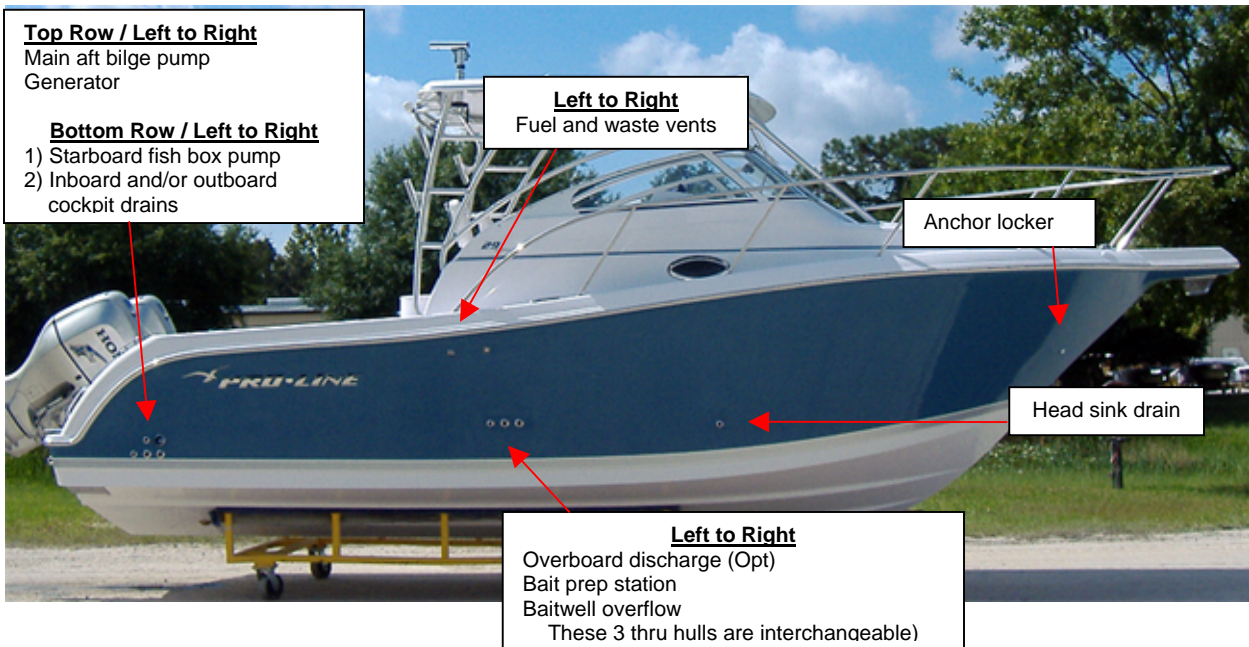

**Grab Rails**

A set of stainless steel grab rails has been installed to provide safe boarding and navigation on the boat. They are located at the starboard transom ladder, around the baitwell station and in the galley



## Gunwale Trim / Rubrail

A white rigid vinyl gunwale trim with a stainless steel insert is installed at the juncture of the deck and hull. This durable trim provides a nice clean look and serves as somewhat of a cushion when you are docking, coming along side another vessel, etc.

See the Service and Care section of this manual for cleaning recommendations.

## Drain Plug

Before launching the boat, always make sure that the drain plug has been installed in the fitting on the transom at the keel. If your boat is being transported, remove the drain plug once the boat is secured on the trailer so that any excess water can be drained via the fitting. Never remove the drain plug when the boat is sitting static in the water.

If you live in an area where it snows and you are storing your boat on a lift during the winter, make sure that you remove the drain plug. When the snow melts, if the float switch for the bilge pump happens to fail, it could flood the bilge and damage electrical components in the bilge.

## Cockpit / Deck Drains

There are four (4) cockpit/deck drains in the aft area of the cockpit that allow excess water in the cockpit to drain overboard via thru hulls on each side of the boat. To ensure that there is no blockage in any of the hoses connected to the drains, it is recommended that you occasionally run water through each of the cockpit drains and visually inspect the thru hulls to verify that water flows freely and that there is no blockage. To trouble shoot, check the hoses for leaks and make certain that all hose connections are secure.



## Dive Platform - Integrated with Ladder

An integrated Euro style dive platform is built into the fiberglass construction of the deck and hull and includes a stainless steel dive ladder on the starboard side of the transom. With the engines tilted down, passengers can move easily through the transom door and across the large dive platform.

An optional dive ladder can be installed on the port side of the dive platform for additional boarding capability. When factory installed, this option includes the installation of an additional grab rail on the port transom. With the engines tilted down, passengers can move easily through the transom door and across the large dive platform to the optional ladder.



## Seating

The following seating comes standard on the 29 Express:

Adjustable helm and port side seats



Aft facing jump seat



Transom (Foldaway)

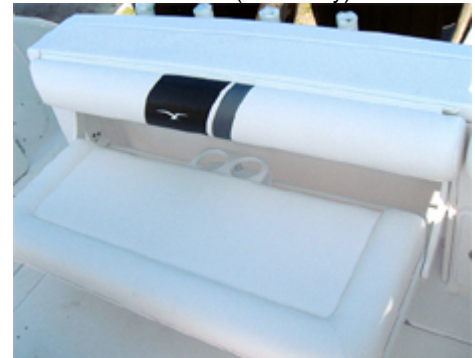

In addition to the standard seating, an optional port lounge seat with storage is available for installation.

## Hard Top with Storage Box (Optional)

The anodized aluminum frame comes with a fiberglass hard top and built in storage box. A set of 4 rod holders is permanently mounted to the aft legs of the frame; providing you with additional rod holder capacity. See the Service and Care section of this manual for cleaning recommendations for the anodized aluminum frame and fiberglass hard top.

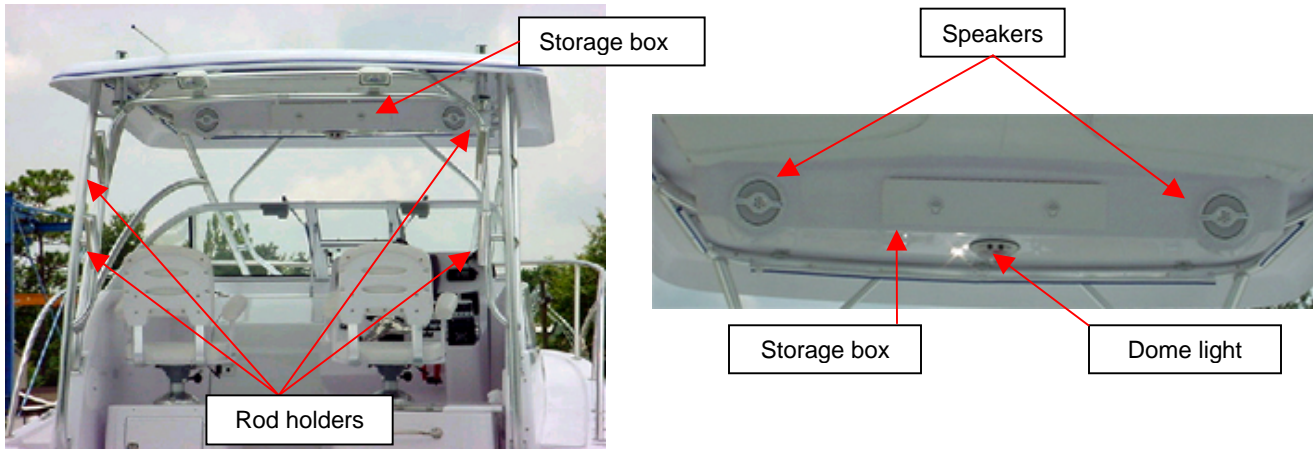

Note: Pro-Line installs mounting pads to the frame for additional support when outriggers are factory installed. Before adding after market outriggers, we recommend that you consult your Pro-Line dealer's Service Department or another qualified service professional to add mounting pads to the hard top frame.

## Hard-Top with Storage Box and Outriggers (Optional)

When factory installed, this option includes the same frame and storage box as above. However, with the installation of the outriggers, we have included mounting pads for additional support.

When this option is selected and factory installed, the outrigger installation includes a pair of outrigger bases, poles and lines. The bases are constructed of anodized aluminum and are installed on the port and starboard sides of the hard top. Turn the handle at the bottom of the outrigger base to rotate the outriggers 90 degrees (from the side to the aft end of the boat).

## Cabin Interior

### Cabin Floors

The fiberglass cabin floor is covered with the same high quality white gelcoat that is used throughout the rest of the boat. The following upgraded floor packages are the perfect compliment to the wood grain cabinetry.

- Laminated Wood Grain Flooring (Optional) – In the main cabin, this flooring is covered with laminated wood grain flooring in cherry and mahogany.
- Teak and Holly (Optional) – In the main cabin, the optional teak and holly flooring is coated with a lacquer finish.

See the Service and Care section of this manual for cleaning recommendations for the flooring products.

### Upholstery

Cabin interiors are outfitted in your choice of patterns and the rest of the cabin is decorated with coordinating pillows, curtains and bolsters.

Patterns available for boats built in early model year 2009 are outfitted in your choice of Geometric Spice or Cosmic Caribbean.

Cabin interiors for boats built later in the 2009 model year are outfitted in your choice of Kioske, Milky Way or Riddle.

**2007 CABIN INTERIOR GEOMETRIC SPICE**



**GEOMETRIC SPICE - DELUXE**  
**28 & 32 Cabins**  
 Invite Spice:  
 V-Berth cushions  
 Welt in berth bolsters and dinette seat back  
 2 pillows  
 Shadow Box Antique:  
 Draperies & Privacy curtains  
 Shadow Box Copperleaf:  
 2 pillows  
 Shadow Box Palomino:  
 1 pillow  
 Madison Cream:  
 Shower Curtain (28E & 32E)  
 Alante Cream (Vynil):  
 Berth Bolsters (fore & aft)  
 Dinette Seating & Backrest

**2007 CABIN INTERIOR COSMIC CARIBBEAN**



**COSMIC CARIBBEAN - DELUXE**  
**28 & 32 Express Cabin**  
 Venadium Caribbean:  
 V-Berth cushions  
 Welt in berth bolsters and dinette seat back  
 Cosmic Bic:  
 2 Pillows  
 Cosmic Lime:  
 1 pillows  
 Surround Cayman:  
 Draperies, Privacy Curtain & 2 Pillows  
 Madison Cream:  
 Shower Curtain (28-35 Express)  
 Alante Cream (Vynil):  
 Berth Bolsters (fore & aft)  
 Dinette Seating & Backrest

**KIOSKE INTERIOR**  
 20E THRU 35E



KIOSKE/BLUE - BERTH 1



REPLICA/BLUE - BERTH 2



CLAIBORNE/IVORY - DRAPERY (WIDE)



HERITAGE/BEACH - BOLSTERS/DINETTE



DELIA/NAVY - PILLOW (WIDE)



DELIA/BUFF - PILLOW (WIDE)



RHONE/DUNE - PILLOW (WIDE)



RIVERVIEW/LT. CAMEL - HEADLINER

**MILKY WAY INTERIOR**  
 20E THRU 35E



MILKY WAY SUNSET - BERTH 1



MILKY WAY SUNSET - BERTH 2



GILMORE/CAFÉ - DRAPERY (WIDE)



HERITAGE/BEACH - BOLSTERS/DINETTE



MILKY WAY/SUNSET - PILLOW (WIDE)



SAHARA CINNAMON - PILLOW (WIDE)



PATINA MULTI - PILLOW (WIDE)



RIVERVIEW/LT. CAMEL - HEADLINER

**RIDDLE INTERIOR**  
20E THRU 35E



KIDSKE/BLUE - BERTH 1



PLACID BERRY - BERTH 2



GILMORE/CAFÉ - DRAPERY (WIDE)



HERITAGE/BEACH - BOLSTERS/DINETTE



DIXIE SALSA - PILLOW (WIDE)



RIVERVIEW/CAMEO - HEADLINER



DIXIE GINSING - PILLOW (WIDE)



PLACID BERRY - PILLOW (WIDE)

**SURFIN SEAGLASS INTERIOR**  
29E / 32E / 35E ONLY



SURFIN SEAGLASS - BERTH 1



RAFFIA CELADON - BERTH 2



RAFFIA CELADON - DRAPERY



HERITAGE/BEACH - BOLSTERS/DINETTE



RAFFIA CELADON - PILLOW



SOLEIL LAGUNA - PILLOW



INCLINE AQUAMARINE - PILLOW



RIVERVIEW/LT. CAMEO - HEADLINER

Please see the Service and Care section of this manual for information on how to clean and care for your cabin cushions, pillows vinyl upholstery.

**Countertops**

The sinks and countertops in the galley and head areas are made of the same gelcoat covered fiberglass that is used in the construction of the deck and hull of the boat. For information on keeping the sink and countertop in the head area looking like new, please refer to the Gelcoat and Fiberglass areas in the Service and Care section of this manual.

Note: Do not place hot pans, curling irons or other hot materials on this Fiberglass countertop as this surface could melt or burn.



### **Wood Grain Cabinetry and Cabin Table**

The galley is outfitted with wood grain Formica cabinetry and a matching table. The table can be left in the raised position for dining or lowered to convert the area into sleeping quarters.

To prepare the berth for sleeping, turn the knob on the table leg, push the table all the way down and then tighten the knob to secure the tabletop in position. The 2<sup>nd</sup> knob on the underside of the tabletop secures the table base to the top. The poly filler pieces are then installed on the tabletop and the filler cushion is placed on top of the poly to finish off the berth.

### **Electronics (Optional)**

Based upon the availability from our vendors, this equipment changes from time to time. Therefore, we request that you refer to the owner's manual provided by the manufacturer of your electronics equipment for operational procedures and for information related to the warranty and the care and maintenance of their product. Refer to your owner's package for additional information.

### **Galvanic Isolator**

The galvanic isolator is located in the cabin, behind the AC/DC panel.

Stray, low voltage current flowing between the AC safety ground and DC bonding system is a principal cause of "galvanic" action. This type of stray current will normally overload your zinc anodes as they try to protect your boat from other near by boats and/or metal objects of the marina. Sacrificial zincs corrode away as they protect metal thru hulls, shafts and props from damaging galvanic corrosion and electrolysis.



Installing the galvanic isolator between the AC safety ground and DC bonding system interrupts the galvanic circuit with other boats and the dock when your boat is plugged into a shore power system. It also maintains an AC safety ground and solves the most common cause of corrosion. Corrosive action on your zincs is significantly reduced while the integrity of the critical safety ground path is maintained. This means a significant savings in boat haul out fees and zinc replacement costs.

The sacrificial zincs are located on the trim tabs and engines. The zincs should be checked periodically and changed when needed.

### **Bonding System**

All metal components that have water either going through them or touching them are bonded to the zinc anodes on the transom of the boat. The zinc anodes should be checked periodically and changed when needed.

# Operation and Performance

## Trim / Tilt

The power trim system allows the operator to raise and lower the motor(s) throughout an infinite number of settings between its upper and lower limits. There is a trim setting that will yield maximum speed, stability or maneuverability for every throttle setting. Refer to your engine manual for specific questions regarding the trim and tilt.

For most conditions, the best all-round performance is obtained when the bow of the boat is slightly out of the water and all motors are trimmed to the same degree.

General trim down (or "in") characteristics are:

- Starting position for best acceleration to plane.
- Lowers the bow, which provides better stability and ride in rough water.
- Reduces boat speed and economy due to increased drag of hull and drive.
- More spray over bow.

General trim up (or "out") characteristics are:

- Raises the bow of the boat out of the water resulting in less hull in the water.
- Greater speed and economy for a given throttle setting.
- Greater maneuverability; provided prop does not ventilate during the maneuver.
- In excess, the reduced stability can lead to bouncing, porpoising and propeller ventilation.

In addition to providing ideal boat performance, the power-trim/tilt enables the motors to be raised (tilted up) for trailering, beaching and launching. Avoid operating the trim switch if travel of the motor is blocked or it has reached the limits of travel.

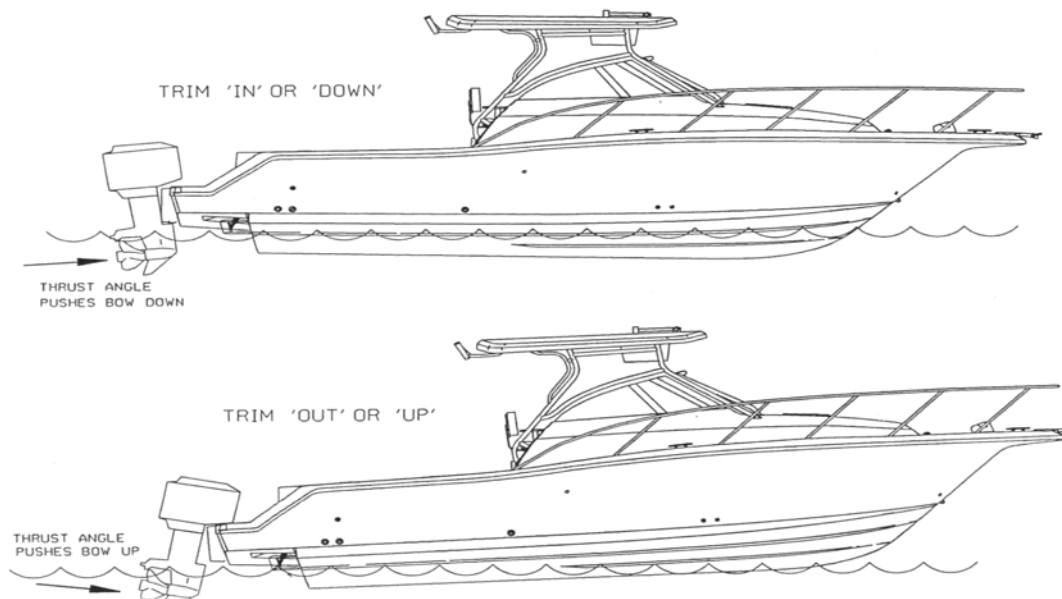

## Propellers

If your Pro-Line was ordered with a factory installed engine, it will have a propeller that has been performance tested to provide the best all-round performance for your engine/hull combination at sea level. In some situations,

it may be desirable to re-prop your Pro-Line to enhance the desired performance needs for your area. For instance:

- Decreasing the pitch will enhance acceleration and power at high loads.
- Increasing the pitch will increase speed at light loads.
- Decreasing the diameter will compensate for any loss of power at high altitudes.
- Increasing the diameter results in higher efficiency at low speeds at the expense of top end speed and acceleration.

Be sure not to over rev the engine when re-propping or engine damage could result. Operating your engine with a damaged prop will decrease performance, increase fuel consumption, and may introduce undesirable handling characteristics. The vibration caused by running a damaged prop could cause costly damage to your lower drive unit.

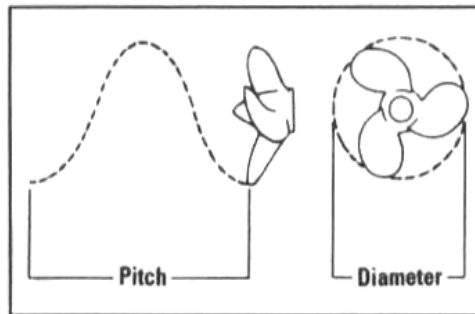

## Starting

Follow the information in your engine manual if it deviates from the following instructions.

### Before Starting the Engines:

- Ventilate all enclosed spaces.
- Visually inspect the bilge for fuel and check for vapors.
- Visually make sure that the propellers are clear of obstructions or swimmers.
- Make sure that the engine cooling water intakes are submerged.
- Lock the helm seat to face straight forward.
- Attach the safety stop switch lanyard.

### Starting the Engines:

Start the engine according to the instructions provided in your engine manual.

### After Starting the Engines:

After your engine starts, make sure to observe a few basic rules to insure the engine is functioning properly:

- Verify engine cooling water circulation.
- Check the temperature gauge for the first few minutes to make sure the engine is warming properly and not overheating.
- Check for fuel, oil and water leaks. If any leaks are found, shut down the engines and make the necessary repairs before continuing on with your voyage.
- Follow the break-in procedures as recommended by the engine manufacturer for your engines.

## Fueling

Certain precautions must be observed when fueling due to the explosive nature of gasoline.

### Before Fueling:

- Secure the boat to the dock with adequate moorings.
- Turn off the engine and any equipment having spark-producing contacts.

- Close doors and hatches so fumes do not enter boat.
- Disembark all persons not necessary for the fueling operation.
- Prohibit all smoking and open flames on board and nearby.
- Have a fire extinguisher close by.

**While Fueling:**

- Keep the nozzle in contact with the fuel fill opening to minimize the possibility of sparks.
- Do not pump fuel into any opening unless it is marked “Fuel” or “Gas”.
- Do not leave the boat unattended.
- Do not spill fuel.
- Do not over fill. Filling a tank until fuel is vented is dangerous.
- Allow room for expansion.

**After Fueling:**

- Close the fuel fill opening.
- Wipe up any spilled fuel and dispose of the rags on shore.
- Open the doors and hatches to ventilate the boat before starting the engines.
- Check for fumes in the bilge and continue to ventilate if fumes are present.

## **Loading**

The performance of any boat is contingent upon the amount of load carried. Reduce the load to permit safe operation in rough and adverse conditions. Heavy loads reduce the performance and increase fuel consumption. The load positioning greatly affects the performance of your boat. If excessive weight is placed too far aft, the boat may have difficulty getting on plane and may ride rough. If the load is concentrated too far forward, the boat may “bow steer” or veer off to the side when entering a large wave at an angle. There may also be a reduction in the top end speed. The optimum load location is generally near the center of the boat.

When loading your Pro-Line, always:

- Maintain a balance both port to starboard and bow to stern.
- Keep heavy items as low as possible.
- When boarding, step (never jump) into the boat one passenger at a time.
- Pass gear from the dock to someone in the boat. Do not carry gear while boarding.
- Never allow passengers to hang their feet over the side of the boat.
- Do not allow passengers to sit or stand on top of the stern or gunwales.
- Do not overload the boat to the point where water enters the cockpit scuppers.



# Service and Care

To enjoy trouble free use of your Pro-Line, follow the recommended procedures and instructions relating to the service and care of your boat. Failure to follow proper maintenance practices will result in shorter life of your equipment and may void your warranty.

Much of the installed equipment on your Pro-Line is warranted separately. Follow the care instructions found in your owner's packet to keep these individual warranties in force.

Your engine manual contains service information relating to your particular engine installation. Follow the engine manufacturer's recommendations for trouble free service and to preserve your warranty rights.

Your new Pro-Line boat is your home away from home. Generally, you should maintain your boat with the same care as you would maintain your home or automobile. Many of the same products used in caring for your home and automobile can be used to maintain your new boat.

## Fiberglass and Gelcoat

The gelcoat covered fiberglass on your Pro-Line provides a smooth, easy to clean and maintain surface. Regular cleaning and waxing will preserve the finish on your boat for many years to come.

Use a mild detergent and plenty of fresh clean water to swab down the exposed gelcoat on your boat. Do not use harsh cleaners containing ammonia, chlorine, or abrasives. Do not use acetone or any ketone solvents. Stubborn stains may be removed with alcohol or kerosene provided they are washed off immediately and completely with a mild detergent and water.

Wax all gelcoat surfaces a minimum of twice a year, more often if the boat is stored in the sun. If neglected, the surface will take on a dull appearance that is not restorable by waxing. Hand buff with a rubbing compound such as Dupont No. 7; or power buff with Mirror Glaze No. 1. Then follow up with a good waxing.

Caution: When power buffing, use care not to leave swirl marks or "burn" the surface. You may want to leave power buffing to a professional.

The gelcoat on your Pro-Line is approximately 25-mil thick. Minor scratches and deep stains that do not penetrate the gelcoat can be lightly wet sanded with 600 grit sand paper, buffed and waxed to remove.

If a deep gouge to the surface occurs that goes through the gelcoat and into the fiberglass, it must be repaired promptly to avoid further damage. Your dealer is best equipped to handle this repair and achieve good bonding and color match. There are many different gelcoat repair kits on the market for this use. However, results obtained may not be satisfactory. See your Pro-Line dealer for fiberglass damage deeper than 1/16 inch.

## Epoxy Barrier Coat and Bottom Paint

If your boat will be in the water continuously, we recommend sealing the bottom of the hull with a high quality barrier coating. Unsealed gelcoat may form water blisters. Repair of water osmosis blister damage is not covered under the limited warranty.

The phenomenon of osmotic blistering is known to occur in saltwater, brackish water and/or fresh water. Any boat left in the water for any period of time is susceptible. Nearly all the marine bottom paint manufacturers today offer coatings that help protect the hull against blistering. If required, contact your Pro-Line dealer's Service Department or another qualified service professional for further information.

We recommend that your boat be cleaned often to prevent unwanted marine growth on the hull and to maintain ultimate high performance. The bottom of your boat must be kept clean. Any buildup of marine life from water will create drag and affect the boat's performance and efficiency. Never use brushes or scouring pads on the bottom of your boat, as this can cause small scratches that will actually trap dirt.

Antifouling bottom paint is designed to dissolve slowly to prevent marine growth. Therefore, the hull bottom should be repainted at the beginning of each boating season. Factors to take into consideration when selecting a protective bottom paint are water temperature, pollution, salinity, current and organic material in the water.

Important: Consult your Pro-Line dealer's Service Department or another qualified service professional for recommended bottom paints and local laws that may govern your area. Many states regulate the chemical content of bottom paints to meet environmental standards and regulations.

Blisters are unforeseen and unexplained phenomena that are relatively undefined. There is no 100% method of prevention, although barrier coating and bottom painting are the best known deterrents.

We recommend that a professional apply the epoxy barrier coat and bottom paint. The hull should be sanded prior to applying the barrier coat and bottom paint. This is done so that the epoxy coat will properly adhere to the hull, and when done correctly, will not void the hull warranty. Pro-Line Boats does not recommend using an etching primer in lieu of sanding the bottom.

Bottom painting is an annual operation but may require more frequent applications if the bottom becomes scratched, damaged, etc. We recommend strict adherence to the manufacturer's recommendations when barrier coating and bottom painting your vessel. There is a small window of time in which the coats must be applied in order to properly complete the application process; therefore, we recommend that a qualified professional do this process.

While barrier coating and bottom painting are the best preventative to blisters caused by the environment, this is in no way a guarantee that they will not occur.

## Graphics

Your graphics may be cleaned with a mild dish cleaning soap and warm water or a good marine grade cleaner that is recommended for cleaning gelcoat. Never use any harsh chemicals, abrasive cleaners or any hard objects, as they will damage the graphics. Be sure to read the manufacturer's directions carefully before using any product on your graphics or gelcoat.

## Gunwale Trim / Rubrail

The gunwale trim/rubrail that is installed at the juncture of the deck and hull is made of flexible, semi-rigid vinyl and a stainless steel insert. The rigid vinyl should be cleaned with the same products used to clean the gelcoat. Please follow the recommendations for stainless steel for cleaning the stainless steel insert.

## Fuel Water Separators

If fuel water separators are installed on your boat, the "spin on" filter cartridges should be renewed every season at a minimum. Fuel tanks that are not kept full accumulate water faster due to condensation. Therefore, filter cartridges may need to be replaced more often depending upon usage and conditions or if motors begin to run rough. When replacing the filters for the fuel water separators, coat the rubber seal with a film of grease or oil to help prevent sticking.

## Water Pumps

The round filter attached to the side of the pumps should be removed and cleaned often with clear water.

## Compass

During periods of long storage, it is recommended that you remove the compass from the boat and store it in a location providing normal room temperature. At low temperatures, an air bubble may form on the top of the

dome. This will in no way affect the reading or accuracy. When restored to normal temperature, the air bubble will disappear.

Clean the Lucite compass dome carefully with a moistened soft cloth to avoid scratching. In salt-water operation, salt crystals from the spray may form on the dome. These crystals should be removed with a moistened soft cloth. A dry cloth and/or harsh rubbing may scratch the compass dome. Any good grade of paste wax can be applied to the dome to retain its luster and optical clarity.

## Aluminum

Aluminum is corrosion resistant but not corrosion proof. The grain structure, when modified by welding processes, has increased susceptibility to micro-corrosion (invisible to the unaided eye) and cracking. Proper care will preserve the weld strength and beauty of your aluminum:

- Always clean frequently with a mild non-abrasive soap and lots of fresh water. Most glass cleaners work well.
- Always protect with a wax, especially around welds to guard against micro-corrosion, cracking and rust spots.
- Always remove rust and corrosion spots, as they appear, with an aluminum cleaner.
- Thoroughly wash the aluminum with a soft towel or sponge using lots of soap and water. Remove all dried salt crystals and other contaminants. Rinse completely with direct water pressure.
- Clean and rinse it well.
- Wash it often enough to keep contaminants from forming or building up.
- Avoid the use of bleach or chlorides to clean the aluminum and/or nearby components. Chlorides can leach onto the aluminum when nearby.
- Never clean with acids or bleaches.
- Avoid abrasive cleaning products. NEVER use sandpaper, steel wool, brass wool, wire brushes, polishing wheels, or rubbing or polishing compounds. These items will remove anodizing and lead to pitting.
- Never permit contact with iron, carbon steel, or other metals, which could cause rust or corrosion.

Pay particular attention when cleaning the tubing directly beneath the top (i.e., hard top, T-top, Bimini top). This area does not receive the natural rinsing action of rainwater and is shielded from the sun. Therefore, it does not dry as completely or quickly as the rest of the frame. The top of the frame is often overlooked when cleaning the boat and should be hand washed and dried often. This area is likely to be the first place that staining or pitting occurs.

Additional information from Taco Metals is included in your owner's package.

## Stainless Steel

Stainless steel is used for bow rails and deck fittings on your Pro-Line. Stainless steel is not completely free from corrosion attack. It is NOT stain or rust proof. When used in contact with chloride salts, sulfides or other rusting metals, stainless will discolor, rust or even corrode. The degree of surface oxidation is directly affected by local atmosphere and saltwater concentrations. All metals are subject to corrosion in some environments. The grain structure of stainless, when modified by welding processes, has increased susceptibility to micro-corrosion (invisible to the unaided eye) and cracking.

Our most helpful recommendation is that you give your stainless steel hardware the same attention that you would use to maintain other materials on your boat. Regular fresh-water washing with a mild abrasive cleaner will keep your stainless bright and beautiful.

- Always clean stainless frequently with soap and water. Any cleaner safe for glass is usually safe for stainless

- Always remove rust spots as soon as possible with a stainless, brass, silver or chrome cleaner. Irreversible pitting will develop under rust that remains on stainless for any period of time.
- Always use a cleaner, like a good car wax, for added beauty and protection.
- Never use coarse abrasives like sandpaper or steel wool on stainless as these can cause rusting.
- Never clean with acids or bleaches.
- Never leave stainless in contact with iron, steel or other metals, which cause contamination leading to rust or corrosion.
- Always protect with a wax, especially around welds to guard against micro-corrosion, cracking and rust spots.

Additional information from Romac and G. G. Schmitt and Sons is included in your owner's package.

## Corrosion Protection

Spray all electrical connections with a good quality corrosion guard annually and whenever an electrical connection is repaired or replaced.

If you moor your Pro-Line in salt water for extended periods, be sure to check the transom mounted anti-corrosion anode often for operation. Check the electrical connections (green wire) on all metallic fittings with anode for conductivity with an ohmmeter. Make sure the anode surface is exposed and not caked with corrosion and scale. Renew the anode if it is more than 50% eroded. Your motor and/or drive unit have a sacrificial zinc anode to mitigate the effects of electrolysis which causes corrosion. Maintain this anode in accordance with the maintenance schedule in your engine manual.

## Cabin / Companionway and Transom Doors

To clean the acrylic door, rinse with fresh water to remove as much grime as possible. Use bare hands with plenty of water so you can feel any grit and avoid grinding it into the surface as you dislodge it. When all material that may scratch the surface is removed, use a soft clean cloth with a non-abrasive mild detergent and fresh water. Rinse and blot dry with a clean dry chamois.

Grease and adhesives may be removed with kerosene, hexane or white gas (not gas you burn in your boat, car, or lawnmower). Never use solvents such as acetone, silicone spray, benzene, carbon tetrachloride, dry cleaning fluid, lacquer or paint thinner, or any chlorinated solvent on acrylic since they may dissolve the material.

## Tackle Box

Clean the tackle box trays and storage area using a soft cloth, warm water and a mild detergent.

## Windows

The frames of the cabin hatches are made of cast or extruded aluminum. The lenses/windows of all 3 styles of windows (cabin hatches, cabin portholes and mid berth cabin window) are made of Lexan or tough acrylic. Clean the frames and windows with a mild soap, lukewarm water and a soft cloth. Make sure that there is no cross contamination on the cloth. Polish with a mild automobile polish.

Minor scratches on the lens/window can be removed or minimized by using a mild automobile polish such as Johnson's Paste Wax or Mirro Glaze Plastic Polish. Use silicone spray on any moving parts to keep the parts free of salt build up.

Note: Do not clean Lexan or acrylic windows with any window cleaner designed specifically for glass windows or any cleaner containing harsh chemicals such as ammonia or alcohol as this will damage the lens/window.

If needed, replacement parts for the 3 window styles (cabin hatches, cabin portholes and the mid berth cabin window) can be obtained from the vendor:

Bomar, A Division of Pompanette  
PO Box W, South East Street  
Charlestown, NH 03603  
603-826-5792 Phone, 603-826-4125 FAX

## Windshield

Care Instructions - Regular cleaning with fresh water and a soft cloth will keep and protect your windshield, window or hatch for years.

- Glass - Use commercially available glass cleaners or a mixture of fresh water and vinegar. Do not use abrasives, harsh chemicals or metal scrapers. Regular cleaning will help assure clarity of the glass for safe boating.
- Window Channels - Clean window channels with mild detergent only. Channels can be sprayed with silicon aerosol while sliding the glass back and forth.
- Metal - Polish with commercially available metal polishes. A boat or car wax applied periodically will offer extra protection against the elements.
- Painted Surfaces - Clean with fresh water periodically. Touch up scratches and areas where paint has chipped off with touch-up spray paint. Touch-up kits are available from the windshield manufacturer.
- Boat Top Clips – Never slide boat top clips along windshield framework. To change a clip location, snap on and off the aluminum top track.
- Windshield Vents - Use care when opening and closing vent. Do not force.
- Grounding - Never ground windshield with any electrical devices or appliances.
- Attaching Any Type of Metal Component to the Frame - Whenever attaching *any* metal component to the windshield frame, the windshield manufacturer recommends bedding all metal fasteners in contact with the aluminum frame with Tef-Gel to prevent the possibility of rust, galvanic corrosion, seizing of moving parts, blistering of painted surfaces, etc. between these two dissimilar metals. See the Tef-Gel website (<http://www.wolfwire.com/tefgel/frameset.htm>) for more details.

## Curtain Package and Windscreen

### Canvas

One of the best ways to keep Sunbrella brand fabrics looking good and to delay the need for deep or vigorous cleanings is to hose fabrics off on a monthly basis with clear water. This practice will help prevent dirt from becoming deeply imbedded in the fabric and eliminate the need for more frequent vigorous cleanings. In most environments, a thorough cleaning will be needed every two to three years. When it's time for a thorough cleaning, Sunbrella fabrics can be cleaned while still installed on your boat. It is important to observe the following:

- Brush off loose dirt.
- Hose down.
- Prepare a cleaning mixture of water and mild soap (Ivory Snow, Dreft or Woolite - no detergents). Water should be cold to lukewarm. Never more than 100 degrees.
- Use a soft bristle brush to clean.
- Allow soap to soak in.
- Rinse thoroughly.
- Air dry. Never apply heat to Sunbrella fabrics.

If stubborn stains persist, you can use a *diluted chlorine bleach/soap mixture* for spot cleaning of mildew, roof run-off or other similar stains. Prepare a special cleaning mixture:

- Four ounces (half cup) of chlorine bleach.
- Two ounces (one-fourth cup) of mild soap.
- One gallon of water.
- Clean with soft bristle brush.
- Allow mixture to soak for up to 20 minutes.
- Rinse thoroughly.
- Air dry.
- Repeat if necessary.

Re-treating the Fabric - Sunbrella fabrics are treated with a fluorocarbon finish to enhance water repellency. This finish is designed to last for several years, but must be replenished after a thorough cleaning. Based on test results, Glen Raven recommends [303 High Tech Fabric Guard™](#) as the preferred re-treatment product for Sunbrella fabrics. Fabrics should be retreated after thorough cleaning or after five years of use. Check with your local Sunbrella dealer or distributor for additional information.

For more information, visit the Sunbrella website at [www.sunbrella.com](http://www.sunbrella.com) for specific recommendations.

### **Isinglass (Windscreen Material)**

When maintaining the Isinglass material, maintenance means "rinsing" with cold water and trying not to rub the dirt into the Isinglass. Never "Dry" dust the Isinglass panels. Any rubbing acts like sandpaper to plastic so keep rubbing to a minimum. Always use lots of cold water and a very very soft cloth when rubbing is required. Do not use paper towels or Terri-cloth towels. Try not to use any cleaning solutions, as most will cause yellowing and cracking.

When you have to store the panels of your windscreen and curtain package, always "roll up" the material to prevent *creases*. Do not fold the Isinglass as this will permanently damage the Isinglass material. Do not roll up the panels when wet, as the material will turn white or fog up. Dry the panels off first using a very very soft cloth before rolling them up. A few hours in the sun will get rid of the whiteness or fogginess in most cases.

## **Vinyl**

### **Interior Vinyl - Cabin Headliner and Cabin Bolsters**

Clean periodically to maintain the appearance of the vinyl and to prevent the build-up of dirt and contaminants. Any stain, spill or soiling should be cleaned promptly to prevent the possibility of permanent staining. When cleaning, always scrub gently using a soft cloth or nylon bristle brush.

Caution: Powered abrasives, abrasive cleaners and steel wool will damage vinyl, as do strong solvents, lacquer solutions and inks. Lotions, suntan oil, waxes and polishes, etc., contain oils and dyes that can cause stiffening and staining of the vinyl. Never use steam, heat guns or hair dryers.

For additional information regarding the care and maintenance of this product, please refer to the Morbern brochure provided in your owner's package for recommended methods to clean specific types of stains.

### **Exterior Vinyl – Upholstered Seats and Cockpit Bolsters**

Vinyl requires periodic cleaning to maintain its neat appearance and to prevent the build-up of dirt and contaminants that may permanently stain and reduce the life of the vinyl if they are not removed. The frequency of cleaning depends on the amount of use and on environmental conditions to which the vinyl is subjected. The procedures used for cleaning are dependent upon the end use circumstances.

For normal cleaning, most stains can be cleaned using warm soapy water and a clear water rinse. Moderate scrubbing with a medium bristle brush will help to loosen soiling material from the depressions of embossed surfaces. For stubborn stains, use either Fantastic or Mr. Clean, which are commercially available mild detergents, in accordance with manufacturers instructions.

For additional information regarding the care and maintenance of this product, please refer to the Morbern brochure provided in your owner's package for recommended methods to clean specific types of stains.

## Cloth

### Cabin Cushions, Pillows and Curtains

The manufacturer of the materials used in making the cabin cushions, pillows and curtains recommends the following cleaning procedures:

Spot clean only with water based shampoo or foam upholstery cleaner. Pretest a small, inconspicuous area before proceeding. Do not over wet. Do not use solvents to spot clean. Pile fabrics may require brushing with a non-metallic, stiff bristle brush to restore appearance.

Note: Water extraction or steam cleaning is not a recommended cleaning method. Cushion covers should not be removed and laundered. To prevent overall soiling, frequent vacuuming or light brushing with a non-metallic, stiff bristle brush to remove dust and grime is recommended. When cleaning a spill, blot immediately to remove spilled material. Clean spot stains from the outside to the middle of the affected area to prevent circling.

Use a professional furniture cleaning service when an overall soiled condition has been reached.

For additional information regarding the care and maintenance of this product, please refer to the Morbern brochure provided in your owner's package for recommended methods to clean specific types of stains.

## Appliances

### Refrigerator

Do not use abrasive cleaning agents or hard objects during cleaning as these can damage the refrigerator. Never use hard or pointed tools to remove ice or to loosen objects, which have frozen in place. As soon as the refrigerator becomes dirty, clean it with a damp cloth. Wipe the refrigerator with a dry cloth after cleaning. Make sure that no water drips into or through the sealing while cleaning as this can damage the electronics.

### Microwave

Keep the inside of the oven clean. When spilled liquids or food splatters adhere to the oven walls, wipe the walls clean with a damp cloth. Mild detergent may be used if the oven gets very dirty. Avoid the use of spray and other harsh cleaners and they may stain, streak or dull the door surface. The outside surfaces should be cleaned with a damp cloth. To prevent damage to the operating parts inside the oven, water should not be allowed to seep into the ventilation openings. The glass tray may be cleaned with warm sudsy water or in a dishwasher.

### Stove

The outside of the stove can be wiped clean with a mild solution of dishwashing detergent and warm water. Avoid abrasive cleaners or cleaning pads. Dry thoroughly before use. The removable grate/drip pan is dishwasher safe. Use gentle scrubbing with a dry bristle brush when cleaning the burner head. Make sure all gas openings are free of obstructions.

## Flooring

### Laminated Wood Grain Flooring

Pick up loose dirt with a vacuum cleaner or Dust Buster and wipe up spilled materials with a clean damp cloth. For normal cleaning, use only a mild dishwashing soap (i.e., Dawn, Ivory, etc.), warm water and a soft cloth. For stubborn stains, please refer to the material in your owner's package that was provided by the manufacturer of the laminated flooring.

### Teak and Holly

The optional teak and holly flooring is covered with a lacquer finish. Pick up loose dirt with a vacuum cleaner or Dust Buster and wipe up spilled materials with a clean damp cloth. For stubborn stains, you may use household

products such as Old English Furniture Polish, Liquid Gold, Pledge, Endust, etc. These products are all commercially available at most grocery stores, Home Depot, Lowes, etc.

## Countertops

The sinks and countertops in the galley and head areas are made of the same gelcoat covered *fiberglass* that is used in the construction of the deck and hull of the boat.

Please refer to the fiberglass and gelcoat section of this chapter for cleaning recommendations.

Note: Do not place hot pans, curling irons or other hot materials on this *Fiberglass* countertop as this surface could melt or burn.

## Formica

Clean the tabletop and cabinets with warm soapy water and/or a good quality Formica cleaner available at Home Depot, Lowes, etc. Maintain it just as you would care for any Formica counter.

## Winterizing and Storage

Your new Pro-Line was winterized before it left the factory. If you launch the boat prior to storing it for the winter, please complete and/or comply with the following check list in order to ensure an easy "fitting out" in the spring:

### Pre-Storage Check List:

- Remove drain plugs, keeping the bow high to drain any water accumulation.
- Run a pint of RV antifreeze through the bilge pump.
- Drain all water systems, including the head, and pump an approved antifreeze through all pumps, valves, drains and lines.
- Fill fuel tank (3/4 – 7/8 full) and add a stabilizer/conditioner such as "STA-BIL" to the gasoline.
- Prepare engine in accordance with the engine manufacturer's recommendations found in your engine manual.
- Treat metal parts with a rust inhibitor.
- To prevent mold and mildew, use an absorbing product such as DampRid according to the manufacturer's directions. An alternative and inexpensive option is to fill egg cartons with charcoal briquettes that have not been pre-treated with lighter fluid.
- Remove batteries and protect them from freezing. Trickle charge overnight once a month.
- Place under cover. If the boat is stored on a trailer, loosen tie-down straps and place blocks beneath axles to relieve the load on the tires.

For inboard/outboard engines only, to protect your boat during transport, the following procedures were affected at the factory prior to shipping and will need to be rectified prior to launch:

- Drain plugs on engine block removed.
- Petcocks on engine removed.
- Large hose on re-circulating pump removed.
- Power steering cooler hose removed.
- All other water hoses disconnected (left in place with hose clamps tightened to prevent their loss).

### Fitting Out After Storage

- Check entire fuel system for loose fittings, leaks and damage.
- Clean battery terminals; install battery(s), and coat terminals with a deoxidizing agent.
- Check all thru hull fittings and hoses for obstructions, water tightness and condition.
- Test all lights for proper operation.
- Check wiring, terminal blocks and plugs for loose connections and corrosion.
- Verify switch and equipment operation.
- Check line condition. Inspect anchor and rope.
- Clean out any debris from bilge and cockpit.



- Flush water systems.
- Install hull drain plug.
- Verify operation of equipment before leaving dock.

## Resealing

In the heat and sun, silicone and sealant can degrade over time. We recommend that you reseal around everything that comes in contact with the deck or hull with a high quality silicone such as 3M 5200 sealant annually. This includes but is not limited to the following:

- |              |                       |                                       |
|--------------|-----------------------|---------------------------------------|
| • Cleats     | • Windshield          | • Bimini top hardware                 |
| • Rubrail    | • Dive ladder         | • Bow and transom eyes                |
| • Windlass   | • Motor mounts        | • Access and other hatches            |
| • Grab rails | • Thru hull fittings  | • Clam shell at the anchor locker     |
| • Outriggers | • Bow rail stanchions | • Rigid T-top stanchions and supports |
| • Head door  |                       |                                       |

## Additional Cleaning and Maintenance Products

**Flitz** - For use on brass, copper, stainless steel, chrome, silver, gold, pewter, nickel, factory gun bluing, bonze, platinum, tin, aluminum, magnesium, anodized aluminum, painted surfaces, fiberglass, Plexiglas and plastics. Flitz is available at many marine supply stores, marinas and at Home Depot. For more information on this product, contact the manufacturer at:

Flitz International Ltd., Waterford, WI 53185, 800-558-8611

**Woody Wax** - Can be used on a variety of surfaces such as:

- Aluminum and Metals – T-tops, tuna towers, anodized aluminum, aluminum, stainless, chrome, boat trailers, fishing gear, etc.
- Fiberglass and Non-Skid – Fiberglass, non-skid decks and colored gelcoat.
- Electrical and Engines – Electrical equipment, electrical connections, wiring harnesses, outboards, engines.
- Plastics – Plastic, vinyl seats, Plexiglas.

Be sure to read the manufacturer's information carefully before using Woody Wax products on any component on your boat. For more information regarding this product, visit their website at [www.woody-wax.com](http://www.woody-wax.com).

**Tef-Gel** - The windshield manufacturer recommends bedding all SS fasteners that come in contact with aluminum with Tef-Gel to prevent the galvanic corrosion between these two dissimilar metals. See the Tef-Gel website for more details (<http://www.wolfwire.com/tefgel/frameset.htm>).

**Ivory Soap** and clean warm water – no cross contamination

**Lysol Foaming Cleaner** - Works well for cleaning gelcoat, vinyl and Formica.

# Appendix

## Helpful Check Lists

Print and use these checklists, and do not operate your boat without doing the following:

### Each Time You Go On a Boat Trip

- Make sure you know where CO exhaust outlets are located on your vessel.
- Educate all passengers about the symptoms of CO poisoning and where CO may accumulate.
- When docked or rafted with another boat, be aware of exhaust emissions from the other boat.
- Confirm that water flows from the exhaust outlets when the engines and generator are started.
- Listen for any change in exhaust sound that could indicate an exhaust component failure.
- Test the operation of each CO alarm by pressing the test button.

### Once a Month

- Make sure all exhaust clamps are in place and secure.
- Look for exhaust leaking from exhaust system components. Signs include rust and/or black streaking, water leaks, or corroded or cracked fittings.
- Inspect rubber exhaust hoses for burned, cracked or deteriorated sections. All rubber hoses should be pliable and free of kinks.
- Clean the bilge and all bilge components with a mixture of bleach and water. Then, follow up by misting the bilge and components with WD-40. This includes but is not limited to the hoses, seacocks, pumps, connections, clamps, air conditioner pumps, generator, etc.

### Once a Year

Have a qualified marine technician:

- Replace exhaust hoses if cracking, charring or deterioration is found.
- Ensure that your engines and generator are properly tuned and well maintained.
- Inspect each water pump impeller and the water pump housing. Replace if worn. Make sure cooling systems are in working condition.
- Inspect all metallic exhaust components for cracking, rusting, leaking or loosening. Be sure to check the cylinder head, exhaust manifold, water injection elbow and the threaded adapter nipple between the manifold and the elbow.
- Clean, inspect and confirm proper operation of the generator cooling water anti-siphon valve (if equipped).
- Spray CRC on all of the connections behind the console.

## Boat Identification Information

Owner: \_\_\_\_\_

Home Port: \_\_\_\_\_

Dealer: \_\_\_\_\_

Boat Name: \_\_\_\_\_

Registration Number: \_\_\_\_\_

Hull ID Number: \_\_\_\_\_

Boat Model: \_\_\_\_\_ LOA: \_\_\_\_\_ Beam: \_\_\_\_\_ Draft: \_\_\_\_\_

Vertical Clearance: \_\_\_\_\_ Hull: \_\_\_\_\_ Deck: \_\_\_\_\_ Interior: \_\_\_\_\_

Warranty Registration Date: \_\_\_\_\_

Fuel Capacity (Gallons): \_\_\_\_\_

Ignition Key #: \_\_\_\_\_

Cabin/Head Door Key #: \_\_\_\_\_ Other Key #: \_\_\_\_\_

Radio Call Letters: \_\_\_\_\_ Bat.: \_\_\_\_\_

Engine Make: \_\_\_\_\_ Model: \_\_\_\_\_ HP: \_\_\_\_\_

Port Engine S/N: \_\_\_\_\_ Port Drive S/N: \_\_\_\_\_

Stbd Engine S/N: \_\_\_\_\_ Stbd Drive S/N: \_\_\_\_\_

Prop: Diam: \_\_\_\_\_ Pitch: \_\_\_\_\_ P/N: \_\_\_\_\_

Trailer Make & Model: \_\_\_\_\_

Trailer S/N: \_\_\_\_\_ GVWR: \_\_\_\_\_

Insurance Company: \_\_\_\_\_

Agent: \_\_\_\_\_

Policy #: \_\_\_\_\_ Phone #: \_\_\_\_\_

## Trouble Shooting Chart

<b>PROBLEM:</b>	<b>POSSIBLE CAUSE</b>
Poor speed or fuel economy:	Wrong propeller for load or conditions. Trim is in too far. Load is too far forward or too heavy. Boat has taken on water. Marine growth on hull. Line or anchor is dragging. Fuel is stale or partially blocked. Engine is worn, out of tune or underpowered. Improper rigging. Air intake or exhaust is partially blocked.
Engine cranks but will not start:	Out of fuel. Filter is clogged. Fuel line kinked or fuel vent plugged. Water in fuel. Engine problem (electrical, fuel pump, blockage, etc.). Safety stop switch lanyard not installed.
Engine will not crank:	Drive is in gear (check operation of the throttle release). Battery is weak. Terminals corroded or loose. Engine or drive is damaged.
Engine runs but boat will not go:	Throttle release is engaged. Disconnected shift linkage. Damaged prop, or lower drive unit. Entangled in lines or weeds. Anchor is down.
Prop cavitates:	Trim out too far. Motor is too high. Weeds on prop. Bow heavy, damage to hull. Prop is damaged.
Excessive vibration:	Propeller, engine, or drive unit damaged. Hull damaged.
Boat will not turn:	Steering unit needs fluid or has trapped air. Tiller is disconnected (helm turns). Steering trunion or mechanism jammed (helm won't turn).
Electrical problems:	Corroded wires, terminals or plugs. Broken, loose or short circuited wires. Circuit breaker tripped. Defective switch, device or breaker. In-line fuse blown. Overloaded circuit.
Handling problems like:	
Porpoises	Trimmed out too far, damaged hull (rocker), trim tabs up, stern heavy.
Runs wet	Trimmed in too far, bow heavy, trim tabs down, overloaded for conditions.
Hard ride	Stern heavy, trimmed out too far, going too fast for conditions.
Lists	Loaded to one side, trim tabs set wrong, trimmed too far in, fuel tanks uneven.
Over bank in turn	Trimmed in too far, improperly located load, throttle advanced too far.
Catches in turns	Damaged hull (hook), stern heavy, trim tabs down.