

PRO•LINE

BOATS

2010

Owner's Manual

32

Express



Specifications subject to change without notice. Actual boats may vary from drawings and/or photos.
Copyright 2005 Pro-Line Boats Inc., PO Box 1348, Crystal River, FL 34423
All rights reserved. March 25, 2009

Table of Contents

	Page
Introduction	
Specifications.....	1
Dealer Responsibilities	1
Customer Responsibilities	2
Owner’s Package.....	2
Yacht Certification.....	2
Insurance and Registration	2
Warranty	3
Safety	
Carbon Monoxide	5
Emergency Treatment for CO Poisoning.....	5
Where CO May Accumulate	6
How To Protect Others and Yourself	6
Fire	7
Equipment.....	7
Flooding	7
Hazardous Conditions	8
Passenger Safety	8
Regulations.....	8
Rules of the Road.....	8
Alcohol	9
Controls	
Throttle and Shift Controls (Twin).....	10
Ignition – Binnacle, Forward, Neutral and Reverse Gear Operation	10
Key Switch Alarm	10
Lanyard Stop Switch	10
Electronic Throttle and Shift Controls – Twin (Optional).....	10
Shift / Throttle / Trim	11
Steering - Hydraulic with Tilt	11
Hydraulic Steering (Verado – Power)	11
Steering – Power Assist (Optional – Standard with Verado Power)	11
Power Trim	11
Steering Wheel.....	12
Trim Tabs.....	12
Trim Tab Indicators (Optional)	13
Windlass with Rode and Chain	13
Windlass Foot Switch (Optional).....	13
Bow Thruster (Optional)	13
Systems and Accessories	
Electrical System	15
110 Volt Outlets - GFI Protected.....	15
12-Volt Receptacle.....	15
Battery Charger	15
Switch and Breaker Panel.....	15

	Page
Circuit Breakers	17
Battery Switch for Dual Batteries	18
Alternating and Direct Current Panels (AC/DC Panel)	18
Alternating Current (AC).....	19
Direct Current (DC)	19
Shore Power with Cord	20
Generator (Gas) with Carbon Monoxide Detector and Auto Shut Off (Optional)....	20
Blower.....	22
Lighting Systems	23
Baitwell Light	23
Bilge Lights	23
Navigation and Anchor Lights	23
Cabin Lights	23
Cockpit Lights	24
Remote Spot Light (Optional)	24
Spreader Lights and Courtesy Light (Optional)	24
Underwater Lights (Optional)	25
Instrumentation	25
Compass.....	25
Horn.....	25
Full Instrumentation / Gauges (Digital)	25
Fuel/Oil Systems.....	26
Fuel Tank.....	26
Fuel Fill and Vent	27
Fuel Sender and Fuel Pick Ups	27
Fuel Water Separators	27
Primer Bulbs.....	27
Oil Tank and Fill	28
Fuel / Oil Leaks	28
Air Conditioning System with Heater (Optional)	28
Fresh Water System.....	30
Fresh Water Pump	30
Fresh Water Tank Fill.....	31
Fresh Water Tank.....	31
Fresh Water Stations	31
City Water Hook-Up/Inlet	32
Shower System and Shower Sump Pump	32
Water Heater	32
Head Waste System.....	32
What is the Law?.....	32
Vacuum Flush with Overboard and Dockside Discharge.....	33
Head Macerator Pump	33
Sea Water System.....	34
Bilge Pumps	34
High Water Alarm	35
Baitwell Pump.....	35
Washdown Pump and Raw Water Washdown Hose	36
Fish Boxes with Macerator Pump	36
Storage, Hatches, Windows and Doors	37
Storage	37

	Page
Hatches and Latches	37
Windshield – Tempered Glass with Vent.....	38
Windshield Wipers.....	39
Windows	39
Transom Door	39
Cabin / Companionway Door	40
Hardware	40
Cleats	40
Bow Rail	40
Grab Rails.....	40
Gunwale Trim / Rubrail	40
Thru Hull Fittings	40
Drain Plug.....	41
Cockpit / Deck Drains.....	42
Bow Pulpit with Anchor Roller and Rope Locker Storage	42
Dive Platform - Integrated with Ladder	42
Cabin Appliances and Accessories.....	42
Alcohol / Electric Stove	43
Microwave	43
Refrigerator.....	44
Flat Screen Television with DVD Player and Cable Outlet (Optional)	44
AM/FM Stereo with CD Player, Speakers and Remote (Optional)	44
XM Stereo Upgrade (Optional)	44
Upgraded Stereo Package (Optional).....	45
Cabin Interior	45
Countertops and Sinks.....	45
Cabin Floors	45
Upholstery	45
Cabinetry	47
Hard Top with Storage Box (Optional)	47
Hard Top with Storage Box and Outriggers (Optional)	48
Seating.....	48
Galvanic Isolator	48
Bonding System.....	49
Electronics (Optional)	49

Operation and Performance

Trim / Tilt	50
Propellers.....	50
Starting.....	51
Before Starting the Engines	51
Starting the Engines.....	51
After Starting the Engines	51
Fueling	51
Before Fueling.....	51
While Fueling.....	52
After Fueling	52
Loading	52

Service and Care

Fiberglass and Gelcoat.....	53
Epoxy Barrier Coat and Bottom Paint.....	53
Graphics.....	54
Gunwale Trim / Rubrail.....	54
Fuel Water Separators	54
Water Pumps	54
Compass.....	54
Aluminum.....	55
Stainless Steel.....	55
Corrosion Protection.....	56
Cabin / Companionway and Transom Doors	56
Tackle Box	56
Windshield	56
Windows	57
Curtain Package and Windscreen.....	57
Canvas	57
Isinglass.....	58
Vinyl	58
Interior	58
Exterior	58
Cloth.....	59
Cabin Cushions, Pillows and Curtains.....	59
Countertops and Sinks	59
Galley Countertop	59
Galley Sink	60
Formica	61
Appliances	61
Refrigerator.....	61
Microwave	61
Stove	62
Flooring.....	62
Laminated Wood Grain Flooring.....	62
Teak and Holly	62
Winterizing and Storage	62
Resealing.....	63
Additional Cleaning and Maintenance Products	63

Appendix

Helpful Check Lists.....	64
Each Time You Go On a Boat Trip.....	64
Once a Month.....	64
Once a Year	64
Boat Identification Information.....	65
Trouble Shooting Chart	66

While we endeavor to be as accurate as possible, certain changes in standard equipment, options and the like may have occurred which would not be included in the Owner's Manual. All weights and fuel capacities are estimates and could/will vary with each vessel and with each application. In all cases, consult your local Pro-Line dealer for the most current information.

Introduction

Congratulations on the purchase of your new Pro-Line Boats 32 Express sport fishing boat. Welcome into the proud family of satisfied Pro-Line owners. Every expedition lets you enjoy the outstanding features designed into every boat we construct. Your new Pro-Line is more than just a boat, it's a whole new lifestyle.

Pro-Line's commitment to the needs and wishes of the sport fishing family has resulted in a superior fishing craft providing you with comfort, performance, security, and outstanding fishability. All of our boats comply with U.S. Coast Guard (USCG) safety regulations and are designed and crafted in accordance with the National Marine Manufacturers Association (NMMA), the American Boat and Yacht Council (ABYC) standards, and the Common European directive (CE).

This manual (to be kept onboard your Pro-Line) is designed to provide you with information necessary for the safe, efficient operation and care of your new Pro-Line. Take the time now to carefully review the owner's manual and the additional information in your owner's package to maximize your enjoyment and safety as well as familiarize yourself with your new boat.

We have prepared this manual to help you fully enjoy each voyage while operating your boat safely. While the information in the manual cannot and does not cover every boating situation, we urge you to read this manual carefully and familiarize yourself with the boat before using it. If a specific method or procedure is not recommended, you must make sure that whatever action you take is safe for you, your passengers and others on the water. Always use common sense when boating.

Specifications

Length Overall (LOA)	32' 4"	Bridge Clearance	8' 3"
Beam	10' 10"	w/ Hard Top	10' 0"
Draft		Maximum Horsepower	600 hp
Up	23"	Fuel Capacity	300 gallons
Deadrise	22 degrees	Baitwell Capacity	25 gallons
Weight		Fishbox Capacity (2)	125 gallons
Hull – w/o Engines	9,500 lbs.	Freshwater Capacity	39 gallons
Trailerable	13,400 lbs.	Water Heater Capacity	6 gallons
Cockpit Area	81 sq. ft.	VacuFlush Holding Tank Capacity	10 gallons
Cockpit Depth	29"		

Dealer Responsibilities

Your dealer's responsibilities include but are not limited to:

- Pre-delivery verification of proper rigging and operation. Deliver the boat in water ready condition unless you and your dealer have agreed upon other arrangements.
- Complete the pre-delivery checklist with the customer at the time of delivery.
- Provide adequate orientation in the general operation of your Pro-Line including an explanation of the specific safety considerations regarding the use of the systems and components.
- Provide an explanation of the owner's package and literature, including the warranty registration cards for the vessel, engines and all of the separately warranted equipment and accessories.
- Discuss the terms of all warranties and emphasize the importance of registering each warranty with the specific manufacturers.
- Repair any damages that may have occurred to the boat while the boat has been in the dealer's possession.
- Provide service to Pro-Line boat owners within the locality of the dealership.
- Explain local and out of area service procedures during and after the warranty periods.

Customer Responsibilities

- Review and sign the Pre-Delivery Inspection (PDI) report for the boat and motors with your dealer to ensure that your boat is in top condition when you take delivery.
- Examine the boat at time of delivery to insure that all systems and components are functioning safely and properly. Report any outstanding issues (i.e., scratches, missing items, etc.) to your dealer before or during the delivery of the boat.
- Read all literature and instructions to ensure proper usage and operation of the equipment as well as how to use and maintain all equipment as directed.
- Read and understand the limited warranty. Sign the warranty registration card and mail it to Pro-Line Boats.
- Contact your local Pro-Line dealer for assistance with any warrantable repairs.
- Transportation of your boat to and from your dealer or repair facility for warrantable repairs.
- Schedule your 20-hour boat and engine check up with your dealer.
- Know your boat and the rules of the road before you use your boat.
- **Be proficient in boat handling and safety. This manual is not intended to provide complete training on all aspects of general boat operations. We at Pro-Line urge all boat owners and operators to attend a boating safety course before operating a boat.**

Owner's Package

Each Pro-Line boat comes with an Owner's Package that contains this Owner's Manual along with materials supplied by various manufacturers whose products have been installed on your boat. Manufacturers of certain products (i.e., Stereo, TV, Stove, Refrigerator, Microwave, Engines, Electronics, etc.) provide their own limited warranty and owner's manuals. While we have endeavored to be as accurate as possible in this manual, if you should notice a discrepancy between the information in this manual and that of the individual supplier's manual, *always follow the instructions in the supplier's manual.*

Make sure that you complete the individual warranty cards for these products and forward them on to the respective manufacturers to register for your warranty with them. Retain all materials in your Pro-Line Owner's Package for easy reference.

Yacht Certification

In accordance with the National Marine Manufacturers Association (NMMA) and the American Boat and Yacht Council (ABYC), all boats larger than 26 feet in length are required to be Yacht Certified. Therefore, a per person and/or pound capacity is not assigned to vessels over 26 feet in length. It is up to the operator's discretion to determine a safe load. These yacht standards are based on Standards and Recommended Practices for Small Craft published by the ABYC, 3069 Solomons Island Road, Edgewater, MD 21037 (410-956-1050).

Insurance and Registration

As the owner of the boat, you are legally responsible for all liabilities of operation. Secure **insurance protection** with a reputable insurance company through your local insurance agent.

Learn about and operate your boat in accordance with local, state, and federal laws, regulations, and **registration** requirements.



Warranty

The Pro-Line Boats Limited Warranty is attached to the warranty card. After signing the warranty card, your dealer will provide you with your copy of the warranty and mail the warranty card to Pro-Line Boats, Inc. A copy of the Pro-Line Boats Limited Warranty is also included in this chapter.

The Pro-Line Boats Limited Warranty extends only to parts that were factory installed. Dealer installed items are the responsibility of the dealer. All warrantable repairs are to be completed by an authorized Pro-Line dealer. Your dealer should be able to assist you with any service or warranty related issues.

If for any reason you are dissatisfied with the services performed by your dealer, we suggest that you discuss the matter with the service manager. The service manager is responsible for the quality of service being performed and has a direct interest in resolving your issues to your satisfaction. If the matter is complicated and cannot be resolved to your satisfaction by the service manager, we suggest that you talk to the general manager or owner. In most cases a compromise can be reached.

If the matter cannot be resolved by the dealership to your satisfaction, contact the Pro-Line Boats Customer Service Department by calling 352-795-4111 or by writing to:

Pro-Line Boats, Customer Service Dept. - PO Box 1348 - Crystal River, FL 34423-1348 - FAX: 352-795-9373

So that your dealer and we can provide you with the best possible service, please have the following information available when calling or writing:

- HIN (Hull Identification Number)
- Selling dealer's name and location
- Servicing dealer (if different from selling dealer)
- Nature of problem
- Names of dealership personnel involved with the situation
- Record of service performed and approximate dates

When contacting Pro-Line Boats, please keep in mind that your issue will most likely be resolved at the dealership, using their facilities, equipment, personnel and/or sublet repair facilities.

Note: There are items that are **not covered** by the Pro-Line Boats Limited Warranty, including but not limited to the following:

- Incidental and consequential damages (i.e., storage charges, telephone or rental charges of any type, inconvenience or loss of time or income).
- Damage caused by neglect, lack of maintenance, accident, abnormal operation, improper installation or service.
- Haul-out, launch and towing charges.
- Transportation charges, service call charges and/or travel time to and from a repair facility, customer's home or marina.
- Service requested by customer other than that which is necessary to satisfy the warranty obligation.
- Oils, lubricants or fluids used in normal maintenance.
- Air freight, next-day or second-day air, or any special delivery fees unless pre-approved.
- Gelcoat cracking, chalking, crazing, discoloration, yellowing or blistering.
- Hull blisters that form below the water line: Osmosis blistering is not covered by our limited warranty. The phenomenon of osmotic blistering is known to occur in salt water, brackish water and/or fresh water. Any boat left in the water for any period of time is susceptible. Most marine bottom paint manufacturers offer coatings that help protect the hull against osmosis blistering. We highly recommend that you add a protective coating to your hull. Find out which type of bottom paint is recommended for your area and have an epoxy barrier coat and bottom paint applied by a professional.
- Parts not installed by the factory

The Ten Year Limited Hull Structural Warranty is transferable to subsequent owners for a nominal fee. Please contact your dealer or Pro-Line Boats to obtain the applicable transfer form so that the new owner will have piece of mind knowing that their pre-owned boat comes with the same structural hull warranty protection that was afforded to the original owner.

PRO-LINE BOATS LIMITED WARRANTY – 2010 MODEL YEAR

Ten Year Limited Hull Warranty. Pro-Line warrants to the original retail purchaser ("Purchaser") that for ten (10) years after the date of delivery to its original retail purchaser, each new fiberglass hull manufactured by Pro-Line shall be free from structural defects due to material or workmanship under normal non-commercial use. Hull structural defects are defined as the separation or delamination of the stringers or delamination of the one-piece fiberglass shell below the hull and deck flange.

One Year components warranty. Pro-Line warrants to Purchaser that for one (1) year after the date of delivery to its original retail purchaser, all boat components manufactured by Pro-Line shall be free from defects due to material or workmanship under normal non-commercial use.

Exclusions. This limited warranty does not cover and does not extend to any of the following:

- (a) Hull or component failure caused by normal wear and tear, climatic conditions, misuse, neglect, lack of proper maintenance, accident, fire or other casualty damage, racing, overloading, negligence, modification, or commercial use;
 - (b) Windshield leakage or breakage;
 - (c) components or equipment not originally installed by Pro-Line;
 - (d) components repaired or replaced unless repaired or replaced in accordance with this warranty;
 - (e) fading, chalking, blistering or cracking of any varnish, gel-coat, paint, anti-fouling coating, or metallic finish;
 - (f) tears, cracking, fading, discoloration or mildewing of curtains, cushions, tops, headliners, or other fabric or upholstered items ;
 - (g) cost of removal or reinstallation of any component (including components manufactured by Pro-line), or disassembly and reassembly of the unit containing the component;
 - (h) speed, weight, fuel consumption, and other performance characteristics of the boat.
- ANY ORAL STATEMENT OR PRINTED ADVERTISING REGARDING ANY PERFORMANCE CHARACTERISTIC OF THE BOAT OR ITS COMPONENTS SHALL BE CONSIDERED AN ESTIMATE ONLY AND SHALL NOT BE RELIED UPON AS EXPRESS WARRANTY OR AS A BASIS OF THE BARGAIN FOR THE BOAT OR ITS COMPONENTS;**
- (i) electrolysis, galvanic corrosion, crevice corrosion, or any deterioration of underwater components;
 - (j) components not manufactured by Pro-Line, whether or not warranted by the other manufacturer, even if installed by Pro-Line, including but not limited to engines, propellers, generator sets, controls, electronics, batteries, appliances, and air conditioning. Warranties provided to Pro-Line by component manufacturers shall be passed on to purchaser to the extent that such transfer is permitted by the manufacturer. Pro-Line's selling dealer will identify the authorized service dealer for any such components upon request.

Limitations. THE REPAIR OR REPLACEMENT OF DEFECTIVE PARTS SHALL BE THE PURCHASER'S SOLE AND EXCLUSIVE REMEDY, AND PRO-LINE'S SOLE AND EXCLUSIVE LIABILITY UNDER THIS WARRANTY. Pro-Line's obligation under this warranty is limited to the repair or replacement (at Pro-Line's sole election) of any covered item found to be defective, when delivered by Purchaser pursuant to written authorization and instructions from Pro-Line, round-trip transportation prepaid, to Pro-Line's manufacturing plant or other designated repair facility. Repaired or replaced items are warranted as provided herein for the unexpired portion of the applicable warranty period.

THIS WARRANTY, AND THE RIGHTS AND REMEDIES UNDER IT, IS EXCLUSIVE AND IS GIVEN IN PLACE OF ALL OTHER WARRANTIES, WHETHER EXPRESSED OR IMPLIED, INCLUDING ANY IMPLIED WARRANTY OF MERCHANTABILITY OR FITNESS FOR PARTICULAR PURPOSE, WHETHER ARISING BY LAW, CUSTOM, CONDUCT, OR USAGE OF TRADE. PURCHASER'S REMEDIES SHALL BE LIMITED AS STATED HERE-IN AND PRO-LINE SHALL NOT BE LIABLE FOR ANY INCIDENTAL, CONSEQUENTIAL, OR INDIRECT DAMAGES OR LOSSES RESULTING FROM DEFECTS.

THIS LIMITED WARRANTY GIVES PURCHASER SPECIFIC LEGAL RIGHTS. PURCHASER MAY HAVE OTHER RIGHTS WHICH MAY VARY FROM STATE TO STATE. IN THE EVENT THAT IMPLIED WARRANTIES ARE FOUND TO EXIST UNDER THE LAW OF A PARTICULAR STATE NOTWITHSTANDING THE EXCLUSION CONTAINED HEREIN, THE DURATION OF ANY SUCH WARRANTY SHALL BE LIMITED TO THE DURATION OF THE APPLICABLE LIMITED WARRANTY STATED HEREIN.

THE SELLING DEALER IS NOT AN AGENT OF PRO-LINE OR A CO-WARRANTOR AND IS NOT AUTHORIZED BY PRO-LINE TO AMEND, MODIFY THIS LIMITED WARRANTY IN ANY MANNER.

Pre-delivery Examination. Purchaser represents to Pro-Line that Purchaser has examined the boat and all its component parts, accessories and equipment, to Purchaser's full satisfaction prior to accepting delivery of the boat from Pro-Line, or in the alternative, has been given full opportunity to do so and has declined.

Transferability of Warranty. This limited warranty may be transferred to subsequent purchasers of the boat during the warranty period, provided that such subsequent purchaser pays the required transfer fee to Pro-Line and registers his ownership with Pro-Line within thirty (30) days of such purchase.

Miscellaneous. Pro-Line Boats is a division of American Marine Holdings, LLC. Pro-Line reserves the right to make changes in the design and construction of its products at any time, without notice and without any obligation to incorporate such changes into products of prior manufacture. This limited warranty applies to new boats manufactured by Pro-Line, except as such limited warranty may be transferred to a subsequent purchaser as provided herein. The term "new boats" shall include boats that may have been repaired during the manufacturing process as part of Pro-Line's quality assurance program. This limited warranty contains the entire agreement between both Pro-Line and Purchaser and supercedes all other prior agreements, discussions, negotiations, commitments, and representations, whether oral or written, between them regarding Pro-Line's warranty. If any provision of this limited warranty, or the application of it, is determined to be invalid or unenforceable for any reason, the remainder of this limited warranty and the application of it shall not be affected.

All communications and notices from Purchaser regarding this limited warranty should be sent to: PRO-LINE BOATS, Customer Service Dept., PO Box 1348, Crystal River, Florida 34423-1348. Telephone: (352)-795-4111.

Acknowledgement of Limited Warranty. By signing the accompanying warranty card, Purchaser, (or each Purchaser, if more than one) agrees that he or she has read a copy of this limited warranty in its entirety and understands its terms and conditions. Purchaser (or each of them) acknowledges receipt of a copy of this limited warranty at the time of sale.

Safety

Your Pro-Line boat has been constructed with safety in mind. But, remember, boating safety and the safety of your passengers is YOUR ultimate responsibility. You should fully understand the operations of your vessel as well as the basics in boating safety.

Your local U.S. Coast Guard Auxiliary (USCGA) and the U.S. Power Squadrons (USPS) offer excellent safe boating classes several times a year. If you have not already passed a boating safety course, we recommend that you do so at your earliest convenience.

Plan your trips carefully. Insure ample fuel supply and a reserve. Tell someone where you are going and when you expect to return. Keep current charts onboard. Read USCG boating safety circulars and follow the safety guidelines.

Carbon Monoxide

Be aware of and avoid conditions that can cause Carbon Monoxide poisoning (see USCG boating safety circular 77). Sources of Carbon Monoxide (CO) include any gas or diesel engine and any flame from items such as a charcoal grill, stove or heater. Carbon Monoxide can accumulate to deadly levels in enclosed spaces. Always ventilate occupied areas of the vessel with fresh clean air.

In high concentrations, CO can be fatal within minutes. The effects of CO in lower concentrations are cumulative and can be just as lethal over long periods of time. CO poisoning is often confused with seasickness. So be aware of the following CO symptoms: Itchy and watery eyes, flushed appearance, throbbing temples, inability to think coherently, ringing in the ears, tightness across the chest, headaches, drowsiness, nausea, dizziness, fatigue, vomiting, collapse and convulsions.

Do not stand or swim near the motor when the engine is idling.

Carbon monoxide can harm and even kill you inside or outside your boat!

Did you also know:

- CO symptoms are similar to seasickness or alcohol intoxication?
- CO can affect you whether you're underway, moored or anchored?
- You cannot see, smell or taste CO?
- CO can make you sick in seconds? In high enough concentrations, even a few breaths can be fatal.

Most important of all, did you know CO poisonings are **preventable**? Every boater should be aware of the risks associated with CO - what it is; where it may accumulate; and the symptoms of CO poisoning. To protect yourself, your passengers and those around you, learn all you can about CO.

Emergency Treatment for CO Poisoning

CO poisoning or toxicity is a life-threatening emergency that requires immediate action. The following is a list of things that should be done if CO poisoning is suspected. Proceed with caution. The victim may be in an area of high CO concentration, which means you or others could also be in danger from exposure to CO.

- Evaluate the situation and ventilate the area, if possible.
- Evacuate the area and move affected person(s) to a fresh air environment.
- Observe the victim(s).
- Administer oxygen, if available.
- Contact medical help. If the victim is not breathing, perform rescue breathing or approved cardiopulmonary resuscitation (CPR), as appropriate, until medical help arrives. Prompt action can mean the difference between life and death.

- Shut off potential sources of CO, if possible. Correct ventilation problems and/or repair exhaust problems as appropriate. Investigate the source of CO and take corrective action, such as evacuating and ventilating the area, or shutting off the source of the CO, while at the same time evacuating and ventilating the area.

Where CO May Accumulate - Carbon Monoxide can accumulate anywhere in or around your boat as shown in the following pictures:



Inadequately ventilated canvas enclosures.



Exhaust gas trapped in enclosed places.



Blocked exhaust outlets.



Another vessel's exhaust. CO from the boat docked next to you can be just as deadly.



"Station wagon effect" or back drafting.

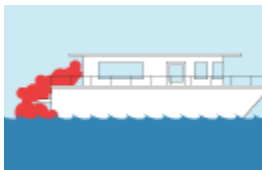

At slow speeds, while idling, or stopped. Be aware that CO can remain in or around your boat at dangerous levels, even if your engine or the other boat's engine is no longer running!

How to Protect Others and Yourself

You are in command of your boating safety. Follow these simple steps to help keep Carbon Monoxide from poisoning you, your passengers or others around you.

- Know where and how CO may accumulate in and around your boat.
- Maintain fresh air circulation throughout the boat at all times. Run exhaust blowers whenever the generator is operating.
- Know where your engine and generator exhaust outlets are located and keep everyone away from these areas.
- Never sit, teak surf or hang on the back deck or swim platform while the engines are running. (Teak Surfing is a new and dangerous boating fad that involves an individual holding on to the

“teak” swim platform of a vessel while a wake builds up then lets go to body surf on the wave created by the boat; hence the term - Teak Surfing.) Teak surfing is never a safe activity.

- Never enter areas under swim platforms where exhaust outlets are located unless the area has been properly ventilated.
- Although CO can be present without the smell of exhaust fumes, if you smell exhaust fumes, CO is also present. Take immediate action to dissipate these fumes.
- Treat symptoms of seasickness as possible CO poisoning. Get the person into fresh air immediately. Seek medical attention unless you are sure it is not CO.
- Install and maintain CO alarms inside your boat. Do not ignore any alarm. Replace alarms as recommended by the alarm manufacturer.
- Get a Vessel Safety Check. A VSC is a free bow-to-stern safety examination.

Fire

- Be aware of and avoid conditions that can lead to accidental fire.
- Guard against and watch for fuel spills and leaks.
- Inspect wiring for damage or exposure that could lead to short circuits or arcing.
- Make sure those who smoke are careful to avoid accidental fire ignition.
- Do not allow smoking while fueling.
- Keep a USCG approved fire extinguisher on board at all times.
- Inspect the fire extinguisher regularly, learn how to use it properly and instruct others as well.
- Use water to fight a fire as a last resort after making arrangements to abandon the boat if a fire should get out of control.
- Keep the following in mind if a fire is burning out of control and you must abandon the boat:
 - Abandon the boat into the wind to minimize burn risk from floating fuel.
 - Wear a PFD unless you must swim under burning fuel.
 - If swimming under burning fuel, throw a PFD outside of the burning area and swim under the burning fuel to it.

Equipment

USCG regulations require that you have the following Coast Guard approved equipment onboard while operating your boat:

- Fire extinguisher(s)
- Personal Flotation Device (PFD) for each occupant
- One throwable PFD
- Sound signal device
- Navigational lights if operated at night
- Sight signal device approved for day and night use when in coastal waters or the great lakes

In addition, here is a list of suggested equipment you should have aboard your Pro-Line:

- First aid kit and blankets
- Mooring lines and fenders
- Combination oar/boat hook
- Spare prop and hardware
- Spare fuses and bulbs
- Local charts and compass
- 2 way radio
- Floating key chain and spare keys
- Emergency food and water
- Anchor and sea anchor with sufficient line
- Bailing device
- Tool kit and lubricant
- Spare fasteners, hose clamps and plugs
- Binoculars
- Waterproof flashlight and spare batteries
- EPIRB (emergency beacon)
- Navigation device
- Waterproof matches or lighter

Flooding

Be aware of and avoid conditions that can cause your boat to flood with water. Possible causes of flooding include:

- Damage to the hull or thru-hull fitting
- Waves washing into the boat
- Water entering cockpit due to improper loading
- Failure to properly install the drain plug.

The boat will become flooded and may swamp, capsize or sink if water enters the boat faster than the bilge pump can expel it.

Hazardous Conditions

Keep track of weather developments and avoid hazardous conditions whenever possible. When forced to operate your Pro-Line in storm conditions:

- Wear PFD's.
- Stow loose gear and equipment.
- Place heavy items as low as possible.
- Head for the easiest port to reach a safe location.
- Reduce speed. You are moving too fast if the boat leaves the water.
- If power fails, anchor or rig a sea anchor off the bow (an empty ice chest in a pinch).
- Stay with the boat if it capsizes, unless it is burning out of control.

Passenger Safety

You are responsible for the safety and conduct of your passengers. Make sure that:

- You instruct your passengers on the proper use and location of PFD's. Children and non-swimmers should wear one at all times.
- Each passenger is in a safe location when underway and knows to keep the boat balanced.
- At least one other person knows how to operate the boat in case of an emergency.
- Your passengers are aware of propeller dangers and the possibility of sudden maneuvers and jolts.
- The **engine is turned off and the key is removed** when swimmers are near the prop or using the dive platform.
- All passengers keep away from lines under stress in case they break and recoil.

Regulations

The USCG is the authority of all waterways. Local authorities enforce State Boating Regulations. You are subject to marine traffic laws and "Rules of the Road" for both federal and state waterways. Therefore, you must submit to boarding if requested by the proper authority. There are many publications available from the Coast Guard concerning regulations. Call the United States Coast Guard Info Line at (800)-368-5647 for additional information.

Rules of the Road

Know and use the "Rules of the Road". Your boat is subject to U.S. Coast Guard enforced marine traffic laws known as "Rules of the Road." There are two sets of rules: the US Inland Navigation Rules and the International Rules. The latter rules are applicable to all vessels inside the demarcation lines separating inland and international waters. You may obtain a copy of the rules from any of the following and by requesting the publication titled "Navigational Rules, International - Inland."

- Your local USGC
- The United States Coast Guard Info Line (800)-368-5647
- The USCG Headquarters by logging on to uscg.mil

The information here is only a “**brief**” overview. **Please** contact the USCG for detailed information.

- Audible warning signals:
 - One short horn blast: starboard course change.
 - Two short horn blasts: port course change.
 - Three short horn blasts: astern operation.
 - Five horn blasts: doubt about previous signal or danger.
 - A Five-second horn blast every minute: for fog operation.
- When overtaking, give-way vessel announces intention with horn blast(s) and waits for a response, then completes maneuver.
- When approaching head-on, both boats give way after giving appropriate horn blast(s) (preferably to starboard).

- When crossing, a vessel converging from starboard has the right-of-way. Port vessel gives way (both acknowledge with one short horn blast).
- Know and observe navigational buoys and markers.
- Give way to craft under sail.

Alcohol

Don't drink and drive. If you have been drinking, appoint someone who is an experienced boater and has not been drinking to be the designated driver. Never operate a boat under the influence of drugs or alcohol. Operation of motorized vessels while under the influence is a Federal offense carrying a significant penalty.

Controls

Controls and engine systems vary greatly from one engine manufacturer to another. Please read your engine owner's manual carefully.

Throttle and Shift Controls for Twin

Ignition – Binnacle, Forward, Neutral and Reverse Gear Operation

The binnacle is located on the console forward of the helm seat. To ensure that the binnacle is working properly, shift the binnacle forward to put the engine in forward gear. Make sure the engine shifts smoothly into idle with no grinding of the gears. Bring the binnacle back into neutral and repeat the same process while going into reverse. Again, ensure that there are no gears grinding. It is important to check the binnacle at wide-open throttle (WOT) to ensure the binnacle is not stiff and operates smoothly while going into the WOT position.

Actual binnacle will vary depending upon the engine package that was selected.

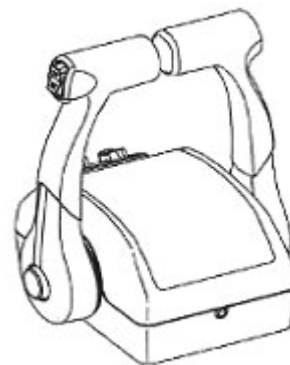

Key Switch Alarm

The key switch alarm is located in the binnacle and sounds when the ignition key is turned on. The key switch alarm is actually a warning alarm that goes off when any overheating problems may occur with the engine. To check the key switch alarm, turn the ignition key to the right but do not start the engine. The alarm will sound ensuring that the engine warning alarm is working properly. When finished, turn the key off.

Lanyard Stop Switch

To ensure the lanyard stop switch (also called the emergency stop feature) on the engine works properly, first turn on the ignition key and start up the engine. While the engine is running, locate the lanyard stop switch. The lanyard stop switch will be either on the base of the binnacle or underneath the ignition key. While the engine is running in the neutral position, pull the lanyard stop switch downward until the plastic element at the end of the lanyard pulls the stop switch pin into the off position. This process will automatically stop the engine and will ensure that the emergency lanyard stop switch is working properly.

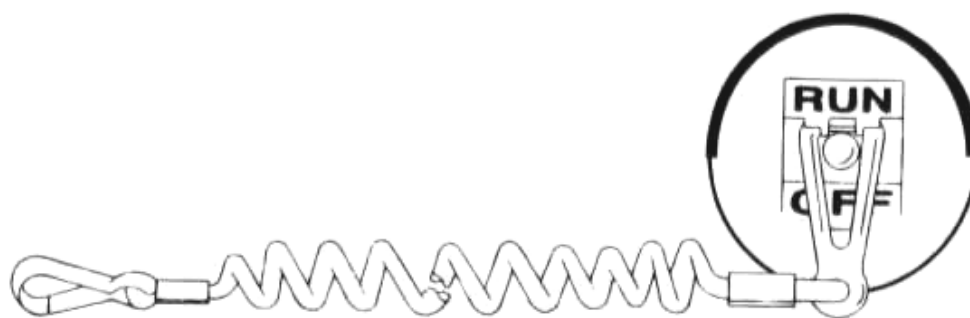

LANYARD STOP SWITCH

Electronic Throttle and Shift Controls – Twin (Optional)

Some engine packages (i.e., Mercury Verado, Mercury Opti Max DTS, etc.) include electronic throttle and shift controls. This option is also available as an option for all other engine packages. The electronic throttle and shift controls provide easier shift and throttle functions and little or no resistance. You may occasionally feel some friction at the binnacle but this can be adjusted at the binnacle per the instructions provided by the engine manufacturer.

Shift / Throttle / Trim

Your Pro-Line can be ordered with different shift/throttle systems based upon motor type. Refer to the owner's packet to find the manual pertaining to your particular installation. Each motor has an individual tilt/trim switch located on the port throttle lever. Separate shift and throttle controls are available for each outboard motor.

The throttle lever has three range positions: "Forward", "Neutral", and "Reverse". The shift function occurs in the first portion of the lever travel. After the transmission is shifted into gear, further movement of the lever advances the throttle.

Push the throttle lever ahead to move forward and pull it back for reverse. Centralize the lever to the detent position for neutral. The throttle lever is equipped with a neutral safety switch to prevent the motor from starting in gear. The initial short movement of the lever to engage the transmission should be made firmly to avoid causing gear clash.

CAUTION: Use care in shifting to avoid advancing the throttle more than intended.

Steering - Hydraulic with Tilt

Steering systems will differ depending upon your selection of engine package. Please carefully read the owner's manual provided by the specific manufacturer. Tilt steering is included with all factory installed engine packages.

Hydraulic Steering (Verado – Power)

Your Pro-Line is equipped with a self-contained hydraulic steering system when your engine package is factory installed. When the steering wheel is turned, the helm pump pumps fluid to the steering cylinder causing it to extend or retract. Periodically, check the fluid level and fill as necessary. Beware of adding too much fluid, especially if the ambient temperature is cold because subsequent expansion could cause leaking or damage to your system. Refer to the owner's manual that was provided by your engine manufacturer.

After every 24 hours of operation check all nuts, caps, and hose fittings for tightness. Make sure the hoses are not chafing or kinking on sharp corners. Also, check that hose ends are not damaged or distorted. The fluid should be changed annually under normal conditions and every six months during times of heavy usage. If your steering does not operate properly, check the following:

- Drive entanglements
- Level of the hydraulic steering fluid
- Hoses and/or fittings for leaks
- Air in the steering system

To properly check the steering system, start by turning the steering wheel port to starboard. If the engine does not respond the same time as the steering wheel is being turned, this means that there is air in the steering system and the steering system needs re-bleeding. When there is air in the steering, the steering wheel will feel "loose". Contact your dealer to have them bleed the steering system.

Steering – Power Assist (Optional – Standard with Verado Power)

Experience the automotive style comfort hydraulic steering can achieve with power assist. It's the perfect addition for boats equipped with standard hydraulic steering. Power assist increases steering comfort with reduced wheel effort. This system is available for 150HP+ single outboards, heavy 4 stroke outboards and twin or triple outboards.



Power Trim

The power trim unit is located on the engine and can be operated by using the trim button on the engine or by using the trim toggle switch on the binnacle. To ensure the power trim is working, start by pressing the toggle trim

switch in the up position and trim the engine to the full up position. Repeat the same process by pressing the trim toggle switch down and the engine will go into the full down position. See the Trim and Tilt information in the Operations section of this manual.

Steering Wheel

The stainless steel steering wheel is mounted at the helm along with the binnacle, switch panel and other controls. Please refer to the Care and Maintenance section of this manual for cleaning recommendations.



Trim Tabs

The trim tabs come equipped with auto retract. The planing tabs are located on each side of the transom on the bottom of the hull. The trim tabs operate independently, up or down, to correct for differing conditions of wind or load. Refer to the owner's packet for specific information.

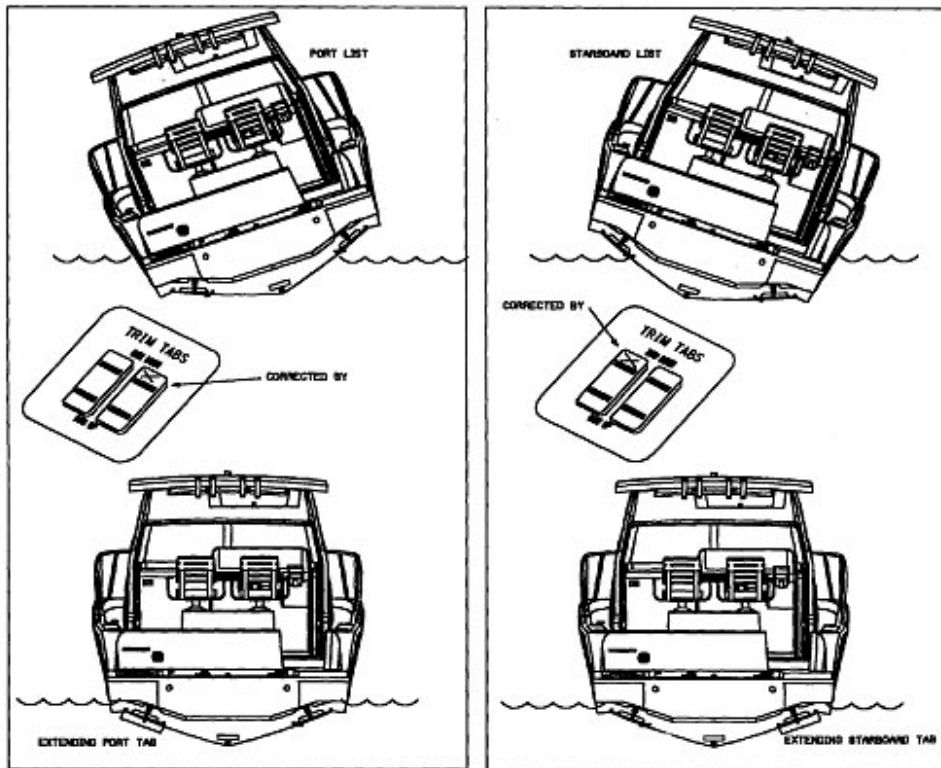

Check the operations of your trim tabs before getting underway. To operate the trim tabs locate the trim tab rocker switches on the console. Press both switches forward and hold them down. This will engage both trim tabs and will ensure they are working properly while in the full down position.

The switch on the port side operates the starboard trim tab. The switch on the starboard side operates the port trim tab. To check each trim tab individually, press one of the trim tab rocker switches to the forward position and check to see if the opposite trim tab goes down. For example if the starboard trim tab switch is being pressed down, the port trim tab should be going down. Repeat the same process for the opposite side.

While underway and in open water, clear of other boaters, depress the top half of the switches in half-second increments to achieve the desired degree of trim. To correct a starboard list, depress the top half of the port switch in small increments until the list is corrected. To avoid over trim, allow a few seconds between tab

adjustments to allow the boat to respond. If you over trim, simply give the over trimmed tab an adjustment in the opposite direction. Push the top half of both rocker switches in half-second increments to trim the bow down.

Warning: Trim tabs can cause a dramatic change in the attitude and heading of your boat. Adjust them in small increments when in open water and clear of any obstructions.

Trim Tab Indicators (Optional)

This optional indicator switch may be added when trim tabs are factory installed standard trim tab package. The waterproof indicator and switch lights up to let you know exactly where your trim tabs are.



Windlass with Rode and Chain

The windlass anchor system is located on the bow. It is an electric hands free anchor system that allows the driver to raise or lower the anchor while staying at the helm. The windlass comes with 200 feet of ½ inch line and 6 feet of ¼ inch rode.

The windlass is operated by a separate switch and is protected by a 50-amp breaker. The switch is located at the helm. The breaker is located on the console in close proximity to the switch.



Windlass



Windlass switch

To operate the windlass, press the windlass toggle switch to the down position to release the anchor and line. After dropping the anchor, be sure to tie the line off at one of the cleats. If you do not tie off at a cleat, the constant pull against the line could cause the windlass motor to fail. To retrieve the anchor, press the windlass switch to the up position and carefully raise the anchor up but not allowing it to hit the boat.

Refer to the owner's manual that was provided by the manufacturer of the windlass for operational procedures and information related to the care and maintenance of their product. When in doubt, always defer to the windlass manufacturer's instructions and/or recommendations.

Windlass Foot Switch (Optional)

The windlass foot switch requires the installation of the windlass with rode and chain. This feature, which includes two (2) foot switches that are installed on the bow of the boat next to the windlass, lets you raise or lower the anchor simply by depressing either the up or down switch.

Refer to the owner's manual that was provided by the manufacturer of the windlass foot switch for operational procedures and information related to the care and maintenance of their product. When in doubt, always defer to the component manufacturer's instructions and/or recommendations.



Bow Thruster (Optional)

When it comes to docking in tight spaces, a bow thruster can be a true godsend – but its benefits don't end there. As a growing number of anglers are discovering, a bow thruster can also prove useful in many fishing situations. The increased maneuverability is a great asset when working a fish. The performance of a single- or multi-engine outboard can be enhanced when a thruster is installed, not only in terms of dockside maneuvering, but also when fighting fish. The bow thruster package includes either a joystick control or a touch pad control.

To engage the thruster, press the on/off switch; the LED light will glow. To move the boat to port, turn the joystick to the left and press the left arrow button. To move the boat to starboard, turn the joystick to the right and press the right arrow button. When the thruster is engaged, the LED light in the switch will glow.

When the thruster is not in use, make sure to disengage the thruster by pressing the on/off switch on the joystick panel; the LED light not glow.

The bow thruster is powered by its own dedicated battery (not included or factory installed), which is installed under the cabin V berth. It is wired to a battery switch that is installed in the storage compartment below the dinette seat. The battery charger charges this battery.

Refer to the owner's manual that was provided by the manufacturer of the bow thruster for operational procedures and information related to the care and maintenance of their product. When in doubt, always defer to the bow thruster manufacturer's instructions and/or recommendations.

Systems and Accessories

Electrical System

110 Volt Outlets - GFI Protected

There are 2 (two) 110-volt ground fault interrupter (GFI) outlets installed in the cabin. One is located in the galley. The other is located on the port wall of the head and is protected by a plastic cover that flips up for easy access. On the AC/DC panel, the switches for these 2 outlets are labeled AC Outlet and Head Outlet.

12 Volt Receptacle

A 12-volt receptacle is installed on the console. It is easily accessible and can be used to charge your cell phone, operate a hand held remote spotlight, etc.

Battery Charger (20 AMP)

The battery charger is installed in the bilge on the aft side of the forward bulkhead. It is designed to recharge your batteries and extend the life of your batteries in applications where the batteries may be stored for long periods of time.

For operational procedures and information related to the care and maintenance of the battery charger, please refer to the owner's manual provided by the manufacturer of the battery charger. When in doubt, always defer to the battery charger manufacturer's instructions and/or recommendations.

Switch and Breaker Panel

The switch and breaker panel is located on the console. The numbers shown below the switches in the photo below correspond with the description provided for each switch.

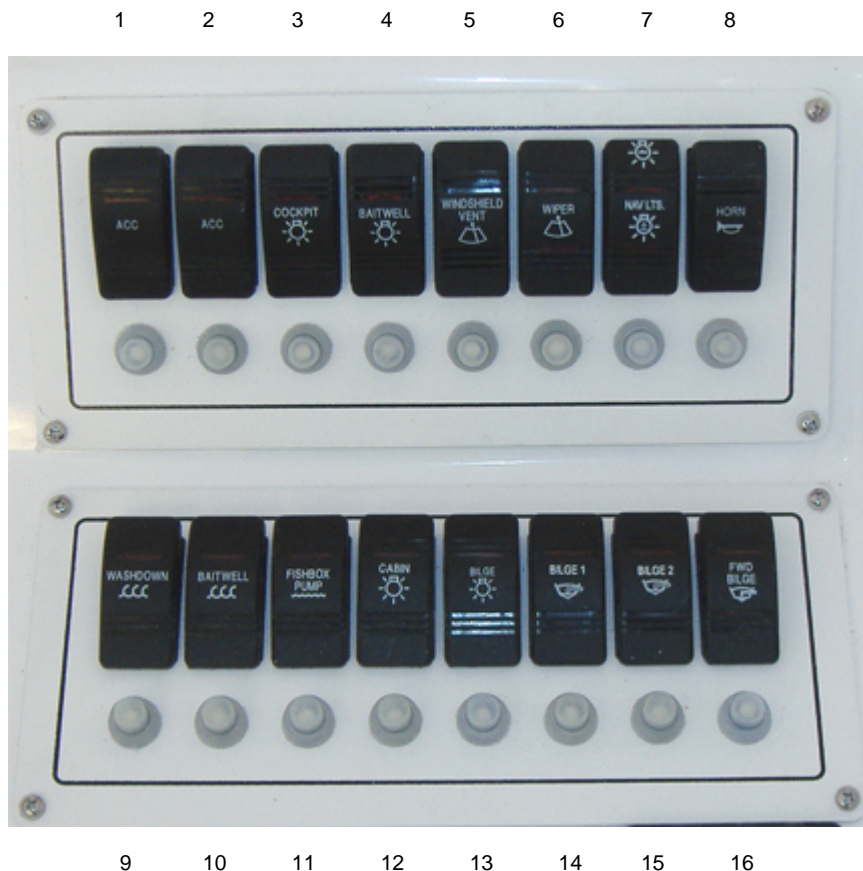

- 1 Accessory - This switch can be used for the optional flat screen television or an additional dealer installed accessory. Please check the amp rating of any new component and/or additional accessory before installation. If you have selected the optional flat screen television, see additional information on this component in the Cabin Appliances and Accessories section of this manual. This switch is rated for 5 Amps.
- 2 Cockpit Lights - Your boat is equipped with cockpit/courtesy lights. The lights have LED (light emitting diode) bulbs with a lifespan of approximately 10,000 hours. To activate the lights, depress the switch to the up or forward position. The lights give off a soft warm light which should not affect your night vision, but will still provide you with enough light to move around your cockpit safely in low visibility conditions.
- 3 Courtesy Light - To activate the cabin courtesy light, which is located behind the cabin stairs, depress the switch to the up or forward position. This is a LED (light emitting diode) light with an approximate life span of 10,000 hours. This light should be left on when using the vessel in low visibility conditions. The courtesy light should have no effect on your night vision. It can also be left on during the night as you would a night-light.
- 4 Baitwell Light - To activate the baitwell light, depress the switch to the up or forward position. This will activate the LED (light emitting diode) light inside your baitwell tub. It is a soft white light that will keep your bait moving and lively. It will also help you locate your bait on those early morning or late night fishing trips. To turn the light off, simply depress the switch to the down or aft position.
- 5 Windshield Vent – The switch that operates the windshield vent is a 3 position momentary switch, which is only active when the button is depressed. To open the windshield vent, depress and hold the switch to the up or forward position. Release the switch when the windshield vent reaches the desired position. When you are ready to close the windshield vent, depress the switch in the down position until the vent window reaches the desired position. Once the vent has traveled to the full out or full in position, you should release the switch. See additional information on this component in the Windows, Hatches and Doors section of this manual.
- 6 Windshield Wipers – Depressing the switch to the up or forward position activates the starboard windshield wiper. Depressing the 3 position switch to the down or aft position will activate both the port and starboard wipers. The center position on the switch is the off position for both wipers. See additional information on this component in the Windows, Hatches and Doors section of this manual.
- 7 Navigation and Anchor Lights - Locate the Nav. light switch on the instrument panel. This is a 3-way switch (forward, middle, back/aft) that functions as follows when you press the switch:
 - Forward position - Turns on the bow lights and the anchor light. This position will also activate the red light in your compass.
 - If you have Faria gauges on the dash panel, this function will illuminate the gauge lights.
 - If the gauges were provided by the engine manufacturer (i.e., Mercury, Honda, etc.), this switch will not illuminate the gauge lights. Instead, your gauge lights will be illuminated when the ignition switch is turned on.
 - Middle position – All lights are off.
 - Back/Aft position – Anchor light is on; the bow lights and gauge lights are off.
- 8 Horn - The horn is used to signal, warn, or alert other boats, swimmers or people on shore. Depress the horn switch to the up or forward position to activate the horn. Release the horn switch to deactivate the horn. Using different sequences of horn blasts indicates different and sometimes dangerous situations to you or someone around you.

Avoid any horn use without an appropriate purpose. See the Safety Section in this manual and/or take a safe boating course for more information on the proper use of the horn.

- 9 Cabin Light (Accessory) – This switch can be used for additional dealer installed accessory. Please check the amp rating of any new component and/or additional accessory before installation. This switch is rated for 5 amps.

- 10 Washdown - To activate the pump, which is located in the bilge, depress the switch to the up or forward position. The washdown pump draws its water from the same seacock that the baitwell pump draws its water. To turn the pump off, depress the switch in the down position. Keep the washdown switch in the off position if the pump is not going to be used soon.
- 11 Baitwell Pump - The baitwell pump is located in the bilge area on the starboard side and it is mounted on a seacock (ball valve). For the baitwell pump to operate properly you need to make sure the seacock is in the open position. The seacock is wide open when the yellow seacock lever is vertical. When the yellow seacock lever is horizontal, the seacock is closed.

The underside of the seacock thru-hull is equipped with a scoop to allow the water to be picked up even when the boat is on plane. When the boat is not in the water or the baitwell pump is not going to be used for an extended period of time, the seacock valve should be in the closed position. To activate the pump, depress the switch to the up or forward position. To turn the pump off after the baitwell tub is full, depress switch to the down or aft position.

- 12 Fish Box Pump - This switch operates the fish box macerator pump that allows you to drain the water and debris from the fish boxes. The macerator pump, which is connected to the collector box (located in the center of the bilge), allows you to pump all the water, ice and scales out of the boxes by grinding up the debris and discharging it overboard.

To activate the pump manually, depress the switch to the up or forward position. This action will drain the fish boxes of water and/or debris, transport it into the collector box/holding tank and then to the macerator pump to be macerated and/or discharged overboard.

When not in use, the switch should be left in the off or down position. Even though your Pro-Line is equipped with a true gutter system, sometimes water will accumulate in the fish boxes. As long as there is power to the fish box macerator pump, the automatic float switches located in the holding tank will activate the pump and automatically discharge the water overboard.

- 13 Bilge Lights – Two bilge lights are mounted on the port and starboard stringers to illuminate the bilge area when you are working on your boat in low visibility conditions. To activate the lights, depress the switch to the up or forward position. Make sure to leave switch in the off or down position when the bilge lights are not in use.

- 14 Bilge Pumps (Bilge 1, Bilge 2, Fwd) - Your boat is equipped with 3 automatic bilge pumps.

15

16

- Bilge 1 – This 1100-gph pump is located in the bilge but it is as far aft as possible. If your vessel is equipped with an optional generator, the pump is located under the generator but is still reachable.
- Bilge 2 – This 1500-gph pump is located in the bilge area and quite visible.
- Fwd Bilge - This 1100-gph pump is located and is accessible via the hinged panel under the mattress in the mid berth.

All bilge pumps are wired automatic to the battery and have a manual override located at the switch panel on the console. The automatic float switches are wired directly to the **Starboard** battery terminals through breakers or inline fuses. Circuit breakers for the main and forward pumps are located at the helm next to the manual switches.

Depressing the applicable bilge pump switch (Bilge 1, Bilge 2 or Fwd) to the up or forward position activates the corresponding bilge pump.

Circuit Breakers

Circuit breakers and/or fuses protect the wiring. In the event a device stops working, check to see if the circuit breaker is tripped or if the fuse is blown. Breakers are installed in the following locations:

- The helm main and DC main breakers are located above the dual battery switches and is accessible via the battery switch hatch located below the transom sink.
- Additional breakers and/or fuses for the bilge pumps, trim tabs, fish box and stereo memory are located next to the main breaker.
- Additional breaker switches are also located on the switch panel above the individual switches.

A tripped breaker will protrude or move from its set position indicating that the circuit has been overloaded. Turn off the device(s) on the circuit, then reset the breaker by pushing in once or by returning a breaker switch to the on position. If the breaker does not reset or if it resets and then trips again after the device is turned back on, then a short circuit exists or your device may be damaged, overloaded, or faulty. Correct the problem and then reset the breaker.

Circuit Breakers – On the switch panel below the individual switches

If the breaker continues to trip and you are certain the device, switch and wiring are in good repair; either the breaker is faulty or it is too small for the load. Reduce the load or replace the breaker.

Battery Switch for Dual Batteries

The battery switches are installed behind the hatch located below the transom sink at the port aft corner of the cockpit. They are for battery isolation, parallel operation and disconnect. The breakers are installed at the top of the battery switch panel and are labeled:

Helm Main, DC Main, Bilge 1, Bilge 2, Fwd. Bilge, Trim Tabs, Fish Box and Stereo Memory.



Caution: To avoid possible alternator/battery damage on twin-engine installations, make sure that the dual battery switches are never left so both engines are connected together, (i.e., never leave a switch on “BOTH” or “ALL”). The preferred switch position is port engine to position one (1) on the port battery switch and starboard engine to position two (2) on the starboard battery switch.

- Place all the switches in the off position.
- Turn both ignition keys on and ensure that the engines will not turn over.
- Turn the port battery switch to the one (1) position on the switch and turn the port ignition key to start the port engine.
- Turn off the port engine ignition key and the port battery switch.
- Turn the starboard battery switch to the two (2) position on the switch and turn the starboard ignition key to start the starboard engine.
- Never switch battery positions while the engines are running

To ensure that both battery switches will turn off, place both switches in the off position and try to start up the engines. When both switches are off, you should not be able to start either engine.

If the breaker continues to trip and you are certain the device, switch and wiring are in good repair; either the breaker is faulty or it is too small for the load. Reduce the load or replace the breaker.

Alternating and Direct Current Panels (AC/DC Panel)

The AC/DC panel (electrical distribution panel) is located inside the cabin, on the starboard aft wall of the main salon. The top half of the panel controls your AC accessories and runs off of shore power (standard equipment) or the generator (optional equipment). The bottom half of the panel controls your DC accessories and runs off of the dealer installed batteries.

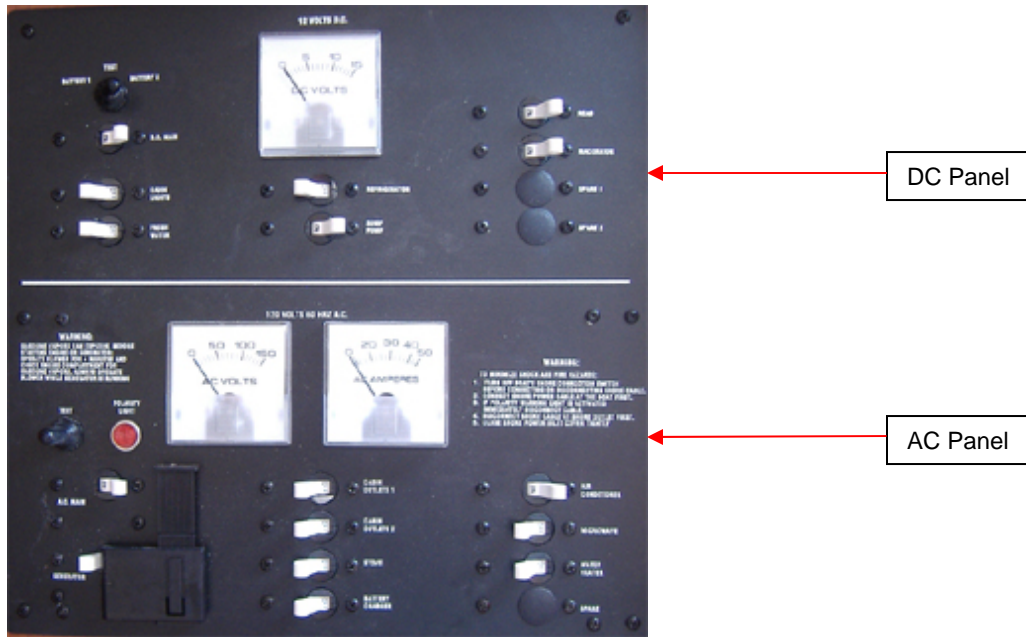

Alternating Current (AC)

Power to your AC accessories is provided either by shore power (standard equipment) or the generator (optional equipment). There is a slide mechanism on the AC panel that will need to be positioned either up or down depending upon which power source you select.

When using your shore power to provide power to the alternating current system, the slide mechanism needs to be in the down position in order to switch the AC main breaker to the on position.

When using your optional generator to provide power to the alternating current system, the slide mechanism needs to be in the up position in order to switch the generator breaker to the on position.

If the Reverse Polarity light (red) comes on, you may have a problem with the shore power cable or your power source. Unplug the shore power immediately and do not use it until a qualified technician corrects this potentially dangerous situation.

The AC volts and the AC amperes gauges allow you to monitor the AC power usage. The system is designed to pull up to 30 amps. If you are pulling more than 30 amps, you should turn off one or more of the breakers for the accessories that you are not using. Pulling more than 30 amps will cause the AC system to trip one or more of the breakers. To avoid tripping breakers, if an accessory is not in use, the breaker should be in the off position. The AC panel provides power to the following:

- Cabin Outlet 1
- Stove
- Air Conditioner
- Water Heater
- Cabin Outlet 2
- Battery Charger
- Microwave
- Spare

Direct Current (DC)

The 12-volt power system is run off your dealer installed batteries. When selecting DC power, switch the DC Main breaker to the on position. The DC panel provides power to the following:

- Cabin Lights
- Refrigerator
- Head
- Spare (For the opt. TV)
- Fresh Water
- Sump Pump
- Macerator
- Spare

Additional DC switches and breakers are located on the console. There is also a DC terminal buss panel located behind the helm. To access this panel, remove the two (2) stainless steel bolts that are installed on the forward side of the helm and tilt the helm aft towards the helm seat. The 12-volt direct current provides electrical power for all lighting, pumps, electronics and DC devices.

The DC volt gauge indicates the maximum number of volts that are available at the DC panel. We recommend that you keep an eye on the volt gauge to make sure that you have enough DC volts available to continue operating the DC equipment that you are currently using. Pulling more than the maximum available volts (12 volts) will cause breakers to trip and will turn off your DC accessories.

Shore Power with Cord

Shore power is used for the operation of AC devices such as your air conditioner, battery charger, and 110-volt outlets for other appliances. The shore power package includes a 25-foot long yellow shore power cord.

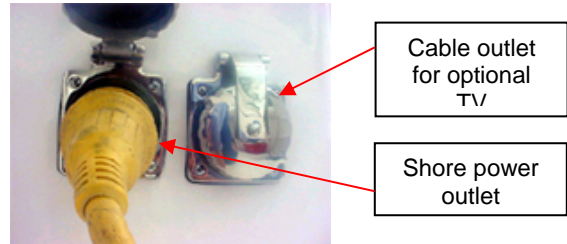

Note: Before attempting to connect to shore power, take precautions to minimize contact arcing by making sure that the AC main breaker switch is in the off position prior to plugging into shore power. The AC main breaker is located on the AC panel on the starboard aft cabin wall.

The shore power outlet is located on the starboard aft wing in close proximity to the mid berth cabin window. To connect your shore power system:

- Turn the shore power outlet fitting and lift it up.
- Plug the shore power cord into the outlet on the boat.
- Connect the shore power cord to the receptacle at your marina or dock.
- Only then should you switch the AC main breaker to on.
- If the reverse polarity light (red) is on, unplug shore power (first at the shore outlet, then at the shore power outlet on the boat) and do not use it, until a qualified technician corrects this potentially dangerous situation.

Please refer to the owner's manual provided by the manufacturer of the shore power unit for operational procedures and for information related to the care and maintenance of their product. When in doubt, always defer to the shore power manufacturer's instructions and/or recommendations.

Generator (Gas) 5.0 kw with Carbon Monoxide Detector and Auto Shut Off (Optional)

If you have selected the optional gas generator, your vessel will come equipped with a remote start/stop for the generator, an hour meter, blower switch and 2 carbon monoxide detectors (one is installed in the V-berth of the main salon and another in the mid berth).

WARNING: The switch for the blower is installed next to the AC/DC panel and should be turned on for four (4) minutes prior to starting your engines or the generator to ensure that the bilge is free from any gas fumes. The blower vents are located on the inside wings of the euro transom/dive platform.

The generator is installed in the aft area of the bilge and can be started either direct from the generator or remotely from the AC panel in the cabin.

Before attempting to operate the generator, the boat must be in the water or have some type of water flushing system going into the generator water pick up. The generator seacock is mounted below the port side hatch in the berth of the mid cabin. Inspect the seacock and ensure that it is open and that the hoses are all connected. The seacock is open when the lever is in the vertical position. Then,

- At the remote control panel for the battery management system (installed on the console), press the house battery switch forward to the on position
- Go into the cabin, locate the AC/DC panel and move the generator toggle switch to the on position.
- Locate the blower switch (installed next to the AC/DC panel) and turn it on. After allowing the blower to run for a few minutes and circulate fresh air throughout the bilge, the generator can be started up.

Starting the Generator from the Main Unit - You can start the unit directly from the generator using the manufacturer's instructions below:

GENERATOR CONTROL PANEL

Starting the Generator

To start the generator, hold the momentary ON switch in the up (on) position, then hold the momentary START/STOP switch in the up (start) position (both switches are held up together). After approximately one second, the starter will engage and the engine will crank. Once the engine is running, the starter will disengage, and the START/STOP switch may then be released to return to its center (run mode) position. Continue holding the ON switch until the engine has sufficient oil pressure, then release it to its center position.

NOTE: Should the engine fail to start, release both switches, wait 20 seconds, and try again. Never run the starter more than 20 seconds at a time.

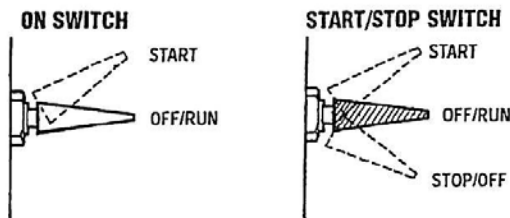

Starting Under Cold Conditions

Make certain the lubricating oil is conforms with the ratings for the prevailing temperature. Check the table under *ENGINE LUBRICATING OIL*. The battery should be fully charged to minimize voltage drop.

Stopping the Generator

To stop the generator, move the momentary START/STOP switch to the down (stop) position then release it to the center (off/run mode) position. This will de-energize the K2 run relay in the generators control panel and stop the generator.

EMERGENCY STOPPING

If the generator does not stop using the START/STOP switch, remove the F1 fuse or disconnect the battery.

CAUTION: Prolonged cranking intervals without the engine starting can result in the engine exhaust system filling with raw water. This may happen because the pump is pumping raw water through the raw water cooling system during cranking. This raw water can enter the engine's cylinders by way of the exhaust manifold once the exhaust system fills. Prevent this from happening by closing the raw water supply through-hull shutoff, draining the exhaust muffler, and correcting the cause of the excessive engine cranking. Engine damage resulting from raw water entry is not a warrantable issue; the owner/operator should keep this in mind.

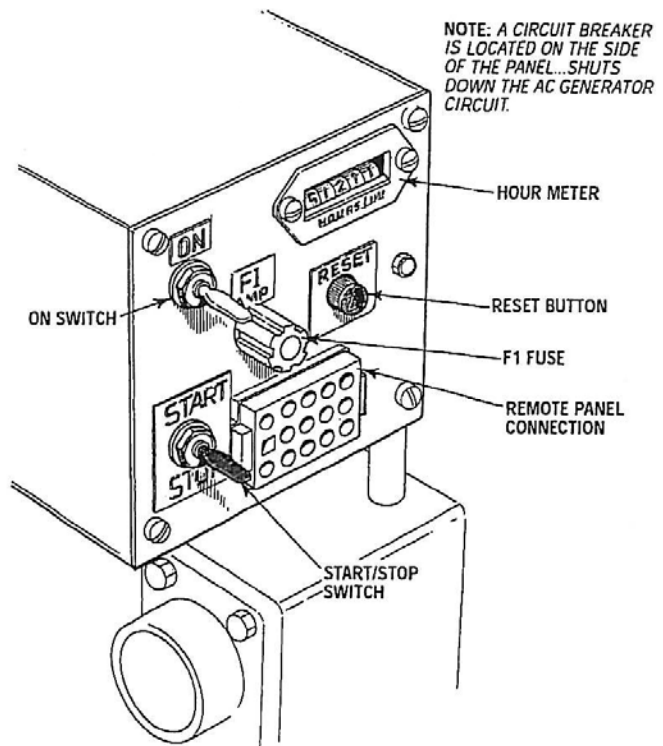

Abnormal Stop

An abnormal stop is one in which the generator ceases to run and comes to a stop as a result of an operating fault which may cause damage to the engine, the generator, or create an unsafe operating condition. The fault stop conditions are:

1. Over speed condition.
2. High engine temperature.
3. Low oil pressure.
4. High exhaust temperature.

Should a fault condition occur, the engine will shutdown. On the remote panel, the green LED light will turn off indicating an engine shutdown. Once detected, the fault should be located and corrected (see *ENGINE TROUBLESHOOTING*).

NOTE: A 30 amp fuse is located at the rear of the control box. This fuse provides protection for the battery charging circuit.

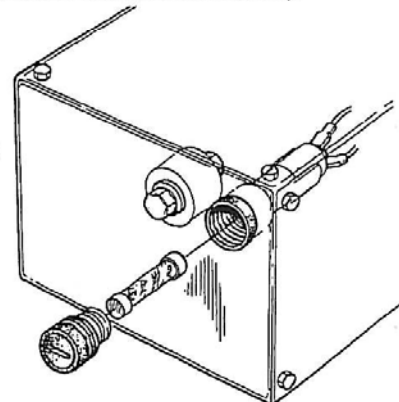

Starting the Generator Remotely from the AC Panel - You can start the unit directly from the generator using the manufacturer's instructions below:

REMOTE PANEL

Starting the Generator

To start the generator, hold the momentary ON switch in the up (*on*) position (the green light will come on), then hold the momentary START/STOP switch in the up (*start*) position (both switches are held up together). After approximately one second, the starter will engage and the engine will crank (the green light will dim). Once the engine is running (the green light will brighten), the starter will disengage, and the START/STOP switch may then be released to return to its center (*run mode*) position. Continue holding the ON switch until the engine has sufficient oil pressure, then release it to its center position.

NOTE: Should the engine fail to start, release both switches, wait 20 seconds, and try again. Never run the starter more than 20 seconds at a time.



REMOTE PANEL

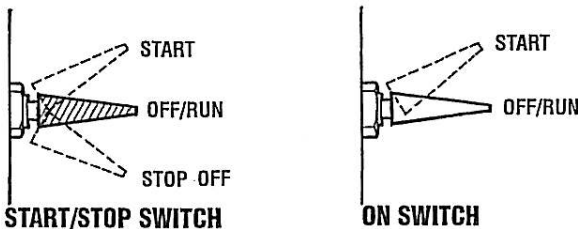

Stopping the Generator

To stop the generator, move the momentary START/STOP switch to the down (*stop*) position then release it to the center (*off/run mode*) position. This will de-energize the K2 run relay in the generator's control panel and stop the generator.

When you have finished using the generator, be sure to turn off the blower.

Note: The manufacturer of the generator provides the limited warranty for the generator and most associated parts. Please refer to their owner's manual and follow their recommendations for scheduled maintenance and service. To be in accordance with the terms and conditions of their limited warranty, all service and/or warranty repairs must be performed by a repair facility that is authorized to work on their equipment.

Please refer to the owner's manual provided by the manufacturer of the generator for operational procedures and for information related to the care and maintenance of their product. When in doubt, always defer to the generator manufacturer's instructions and/or recommendations.

Blower

The blower (standard with the optional gas generator) is located inside the bilge and helps keep fresh air circulating in the bilge area. You should periodically check to make sure that the blower is working properly. First, confirm that the blower hoses are connected and the blower itself is secured. Second, locate the blower switch inside the main cabin and press the switch to the on position. Then, go back to the bilge area and listen to hear if the blower is running. The exhaust vents are located on the outside of the transom on the port and starboard sides. Check to ensure that air is blowing out of the vents. When finished, go back into the cabin and turn the blower switch off.

Blower



Blower Switch



Blower Exhaust Vent



Lighting Systems

Baitwell Light

The baitwell light switch is located on the switch panel and is labeled baitwell with a light symbol on the switch. To turn on the baitwell light, press the switch forward and open the baitwell lid to see if the baitwell light is on. Press the baitwell light switch to the down or aft position to turn off the light.

Bilge Lights

The bilge light switch is located on the switch panel and is labeled bilge with a light symbol on the switch. The 2 bilge lights are installed on the port and starboard stringers. Press the switch forward to turn on the bilge lights. Press the bilge light switch to the down or aft position to turn off the lights.

Navigation and Anchor Lights

The navigation and anchor lights are required to be used for operation at night or under low visibility conditions to indicate your position to other boaters. Visually verify the operation of your Navigation and anchor lights and verify that the lights are free from obstructions. You should check your navigation lights monthly during optimum visibility conditions.

- When you are underway in low visibility conditions, you should have the Nav/Anc switch in the up or forward position. This will activate the navigation lights, as well as your anchor/all around light.
- When you are anchored or in low visibility conditions, you should turn on the anchor/all around light. Press the Nav/Anc switch to the down or aft position to turn on the anchor/all around light.

The navigation lights consist of a pair of stainless steel lights that are mounted at the bow of the boat. The red light is installed on the port side and the green light is installed on the starboard side.

If you have selected the optional hard top, the anchor light will be mounted on the center of the fiberglass top. If you have not selected the optional hard top, the anchor light will be mounted on the windshield frame. This light must be secured in the up position when you are underway.



Cabin Lights

There are cabin lights in the main cabin, the mid berth and the head. The cabin light switches are located on the AC/DC panel inside the cabin, on the starboard aft wall of the main salon. See the instructions for the AC/DC panel for additional information.

Switch the DC main switch and the applicable cabin light switch to the on position to turn on the cabin lights. Each of these lights can then be turned on or off individually. When you are finished using the lights, press the cabin light and DC main switches to the off position.

- Bullet lights are located in the main cabin and in the mid berth. Each light can be turned on individually by turning the switch located on the base of the light.
- A set of strip/deco lights is installed in the main cabin on the shelving around the berth, behind the cabin bolster cushion. This light assembly can be turned on by pressing the switch that is installed on the shelving just forward of the galley cabinets.
- A florescent light is located in the head and can be turned on by flopping the small switch located at the end of the light assembly.
- Dome lights are located in the mid berth and head. They and can be turned on by flipping the small toggle switch on the base of the light assembly.
- A small courtesy light (same style as the cockpit lights) is installed on the forward wall of the mid berth cabin behind the cabin steps. This light can be turned on at the console by pressing the cabin light switch in the forward position. The switches on the AC/DC panel do not control this light.

Cockpit Lights

The cockpit lights are small circular lights located around the cockpit aft of the helm seat. Locate the 2-way cockpit light switch on the switch panel and press the switch in the forward position to turn on the cockpit lights. Press the cockpit light switch in the back or aft position to turn the lights off.



Remote Spot Light (Optional)

The installation of the remote spot light requires the optional hard top. The remote spot light is mounted to the forward area of the fiberglass top. To operate the remote spot light, locate the remote spot light panel that is installed on the console.

Remote spot light



Remote spot light control panel



The switch on the right side of the panel allows you to turn the light on and off. The red LED light located in the center of the panel will be lit when the spot light is turned on. Once the spot light is turned on, the all around toggle lever (on the left side of the panel) can be moved in an up, down, left or right position to rotate the light assembly in the desired direction.

Spreader Lights and Courtesy Light (Optional)

The installation of the spreader lights and courtesy light requires the optional hard top. The spreader lights are mounted to the aft side of the hard top frame, next to the hard top rod holders. The dome shaped courtesy light is mounted to the bottom of the hard top electronics box.

Spreader lights



Courtesy/Dome light



Two push in switches for the spreader lights and courtesy light are located on the base of the courtesy light.

- To operate the dome shaped courtesy light - Press the switch labeled courtesy once to turn on the white courtesy light. When you press the same switch a 2nd time, the white courtesy light will be turned off and the red courtesy light (for night vision) will turn on. Press the same switch a 3rd time to turn off the red courtesy light.

- To operate the spreader lights - The spreader light switch operates in the same manor as the courtesy light but only needs to be pressed in once to be turned on and once again to be turned off.

Underwater Lights (Optional)

A pair of underwater lights can be installed on the hull just below the water line. The lights have LED (light emitting diode) bulbs with a lifespan of approximately 20,000 hours. The lights give off a soft warm light that attracts baitfish, which in turn attracts larger fish. They also provide a little ambiance for those romantic evenings.

A separate light switch panel is installed on the console. Just set the switch in the on position to thru the lights on and set the switch in the off position to turn the lights off.



Instrumentation

Compass

The compass is installed on the dash on top of the console. To ensure that the compass light is working properly, press the Nav/Anc switch in the forward position to turn on the red LED light inside the compass. When finished, turn the Nav/Anc switch back to the middle position.

Please refer to the owner's manual provided by the manufacturer of the compass for operational procedures and for information related to the care and maintenance of their product. When in doubt, always defer to the compass manufacturer's instructions and/or recommendations.



Horn

To check and see if the horn is working properly, press the horn switch in the forward position and listen to hear the horn.

The horn is used to signal, warn or alert other boats or persons on shore. The horn switch is located on the switch panel. The horn device is located on the starboard gunwale just aft of the starboard navigation light. Depress the horn switch to the up or forward position to activate the horn, then release the horn switch to deactivate the horn. Using different sequences of horn blasts indicates different and sometimes dangerous situations to you or someone around you.

See the Safety Section in this manual for more information. Avoid any horn use without an appropriate purpose. Additional information regarding audible warning signals should be covered in a safe boating course.

Full Instrumentation / Gauges (Digital)

All gauges are installed on the console but the configuration and specific location of your gauges will vary depending upon the selection of the various optional engine packages. If your engine package includes analog gauges (i.e., Faria), the gauges will light up when the navigation lights are on. If your engine package includes digital gauges provided by the engine manufacturer (i.e., Mercury SmartCraft, Honda, etc.), the gauges will light up only when the engine is on.

Note: For boats rigged with analog gauges (i.e., Faria), the gauge configuration may include individual gauges for the temperature, trim, volts and fuel gauges or a multifunction gauge that includes these 4 gauge functions. For boats rigged with digital gauges, the temperature, trim, volts and fuel gauges are incorporated into the tachometer gauge.

Tachometer - To ensure the tachometer (tach) is working properly, simply turn the ignition key on and start the engine. While the engine is idling, the tach should be reading in the proper RPM range recommended for the engine. Your engine manual will indicate the appropriate RPM range. When you are running at wide-open throttle, the tach should read near the top end of the recommended RPM range.

If the RPM gauge is reading correctly and the engine throttle settings are correct, the tachometer is operating properly. If the tachometer is not reading correctly, refer to the manual provided by the manufacturer of the gauge (included in your owner's package).

Speedometer - To ensure that the speedometer (Speedo) is working properly, get the boat on a planing speed and check to see if the gauge is reading at the approximate running speed at which the boat is traveling.

Note: The speed-reading on the speed may vary a few MPH from the actual speed that the boat is traveling. Either a GPS or a radar gun can check the running speed.

Trim - To ensure the trim gauges/indicators are working properly, start by making sure the engine is trimmed all the way down. Locate the trim gauge on the instrument panel and check to see if the level on the trim gauge is in the full down position. As you trim the engine up, watch the trim gauge and ensure that it coincides with the actual trim of the engine. When finished trimming the engine all the way up, the level on the trim gauge should read in the full up position.

Volts - To system check the volt gauge, turn the ignition key on and turn on the engine. With the engine running, check the reading on the volt gauge. It should be reading between 12 and 14.5 volts. This reading ensures that the charging system and the volt gauge are working properly.

Fuel - The fuel gauge reads the amount of fuel remaining in the tank. To check the fuel gauge, place a known amount of fuel into the fuel fill and fill the tank. Turn the ignition key on and the fuel gauge should read the approximate amount of fuel in the tank.

For example: If the fuel tank holds 300 gallons of fuel and you pumped 75 gallons of fuel into the tank, the fuel gauge should read approximately 1/4 of a tank. This ensures that the fuel gauge and the fuel sender are working properly.

If the fuel gauge is not reading correctly, we recommend that you have the fuel sender checked by a qualified professional before considering changing out the gauge. For more information, please refer to the Fuel/Oil Systems section of this manual.

For specific information related to your gauges, refer to the material in your owner's package that was provided by the gauge manufacturer.

Fuel/Oil Systems

Fuel Tank

The 300-gallon fuel tank on your Pro-Line is constructed of heavy gauge aluminum with internal baffling to minimize sloshing. The fuel tank is located under the deck and is secured between the stringers and bulkheads.

Inspect the hose connections on a regular basis. To access the fuel fill and fuel vent hoses at the tank, go into the mid berth and remove the round access pie located on the right side of the window opening. The other end of these two hoses can be accessed via the round deck plate that is installed just below the fuel fill on the inside the cockpit.

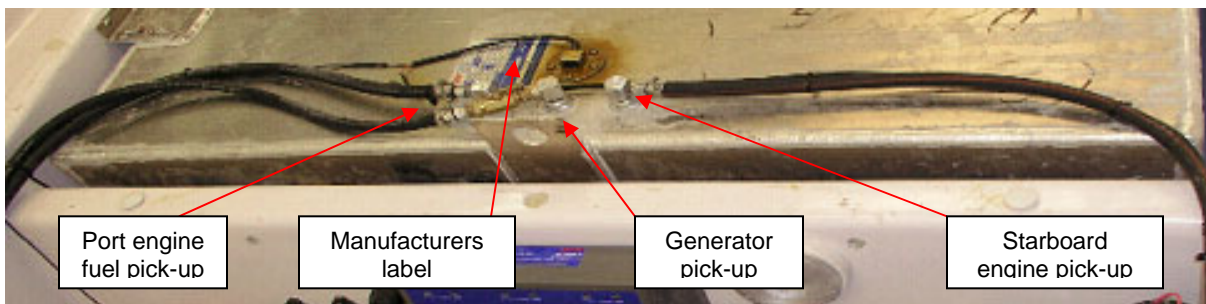

Fuel Fill and Vent

The fuel fill is a stainless steel fitting labeled “Gas” or “Fuel” and is located approximately amidships on the starboard gunwale. Twist the cap to open the fitting. The cap is connected to the fitting by a chain or cable so that it will not fall into the water and/or get lost. Be careful not to pump fuel into any other fitting on the vessel.



The external fuel vent is located just below the fuel fill on the outside of the hull, and the gas tank is vented overboard. While you are filling the tank, fuel entering the tank pushes air in the tank out through the fuel vent.



Note: Never pump fuel into any fitting, opening or access on the boat unless it is labeled “Gas” or “Fuel”.

Fuel Sender and Fuel Pick Ups

To access the fuel sender and fuel pick up, lift the bilge hatch. At the forward edge of the hatch opening, there is a rectangular panel that is held in place with 6 screws. When you remove the panel, you will see the fuel sender and fuel pick-ups.

The fuel sender is equipped with a float that moves up and down with the fuel level in the tank. The fuel level information is sent to the fuel gauge and keeps you informed of the approximate fuel level in the tank. If you feel that your fuel gauge is reading incorrectly, before considering changing the gauge, have your Pro-Line dealer’s Service Department or a qualified professional remove the fuel sender and check to make sure that the float is able to move up and down freely.

Fuel Water Separators

Depending on your selection of the various optional engine packages, your boat may be equipped with a fuel water separator for each engine. However, some engines come equipped with a built in fuel water separator. Please refer to the owner’s manual provided by the manufacturer of your engine package for operational procedures and for information related to the care and maintenance of their product. When in doubt, always defer to the engine manufacturer’s instructions and/or recommendations.

If your engine package requires the installation of fuel water separators, they will be mounted in the bilge on the inside of the port and starboard stringers. There is one unit for each motor. The “spin on” filter cartridges should be renewed every season at a minimum. Fuel tanks that are not kept full accumulate water faster due to condensation. Therefore, the filter cartridges may need to be replaced more often depending upon usage and conditions or if motors begin to run rough. When replacing the filter cartridges for the fuel water separators, coat the rubber seal with a film of grease or oil to help prevent sticking.

If water should somehow enter your fuel tank via condensation, your fuel source, etc., it will become trapped in the fuel water separator before it is able to travel through the fuel system and to your engine.

If you have selected the optional air conditioner system, a designated fuel water separator will also be installed on the inside of the port stringer specifically for this optional installation.

Please refer to the owner’s manual provided by your engine manufacturer for proper procedures. Some engines will not have a separate fuel water separator located in the bilge. Instead it will be located on the engine itself. Check engine specs.

Primer Bulbs

There is a primer bulb installed for each engine and it is used to prime the fuel pump in the motor with fuel. Squeeze the primer bulb a few times until resistance is felt in order to prime. If no resistance develops and the fuel pump will not prime, you may be out of fuel, the primer bulb may be defective, or a leak may have developed allowing air into the system. Primer bulbs (if applicable) are located with the rigging tubes where they exit the bilge and are easy to get to by standing on the dive platform.

Note: Not all engines require primer bulbs. Refer to the engine manual for verification.

Oil Tank and Fill

Depending on your selection of the various optional engine packages (i.e., oil injected outboard engines), your boat may be equipped with remote oil tanks. If your engine package requires the installation of an oil tank, it will be mounted in the bilge beneath the transom sink and can be accessed by removing the battery switch panel. The oil fill will be installed starboard of the transom sink in the recess beneath the transom sink lid.

Make sure that the oil tanks are well stocked with the type of engine oil that is recommended for your engines. Refer to your engine manual. It is imperative that the oil supply remains clean and uncontaminated by water or dirt. Check to make sure the oil lines are free from leaks, kinks and chafing. Some motors use a primer bulb to initiate oil flow. Air may periodically enter the system and require purging. Refer to your engine manual for specific instructions.

If your optional engine package requires the installation of remote oil tanks, please refer to the owner's manual provided by the engine manufacturer for operational procedures and for information related to the care and maintenance of their product. When in doubt, always defer to the engine manufacturer's instructions and/or recommendations.

Fuel / Oil Leaks

The fuel tank is vented overboard and the vent should be inspected for obstructions regularly. Ensure all of the fuel hoses remain properly secured and located according to NMMA standards. Inspect all hose clamps and fittings to ensure they are double clamped where needed and that there are no fuel leaks in any of the hoses. Also, inspect the oil system, if applicable, and ensure that the oil tank and hoses remain properly connected and secured.

If you notice a fuel odor or see fuel in the bilge, there may be a leak somewhere in the fuel system. Correct any fuel leaks before operating the vessel.

Caution: If at all possible, any fuel tank and or fuel system repair should be handled by your dealer's service department or by another qualified professional.

Air Conditioning System with Heater (Optional)

The air conditioner unit is installed under the V berth in the main salon of the cabin and comes equipped with 3 types of vents that are located in the main salon, the mid berth and the head. The air conditioner return is installed on the aft wall of the center V berth storage area. The air conditioner runs off shore power or the generator (optional equipment), not the battery.

The breaker switch for the air conditioner is located on the AC/DC panel in the cabin. Turn the switch to the on position.



Air conditioner return on the face of the V berth storage area



Air conditioning vent
In main salon



Air conditioning vents in
mid berth cabin and head



Then, turn on the blower switch, which is located next to the AC/DC panel.

Once both switches have been set, go to the air conditioner thermostat control panel. This panel is installed on the port wall of the cabin in close proximity to the AC/DC panel.

Press the on/off button on the air conditioner thermostat panel once to activate the system. Press the fan button to navigate between the various fan speeds. The up (warmer) and down (cooler) arrow buttons allow you to control the temperature which is also displayed at the top of the air conditioner thermostat panel (refer to the manufacturer's owners manual). The air conditioning thru hull on the side of the boat will be releasing water to ensure that the air conditioner is running cool.



Note: The air conditioner seacock is located inside the cabin beneath the mid berth. This seacock must be in the open position to operate the generator.

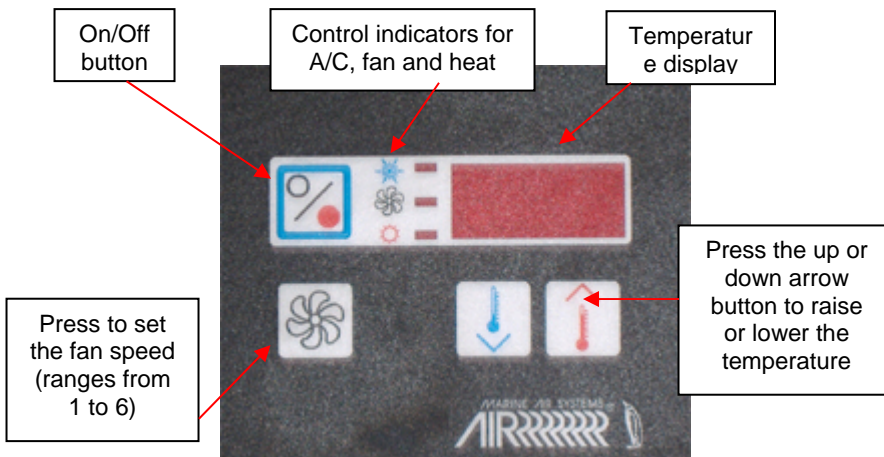

Air conditioner seacock lever (yellow lever at bottom of photo) is shown in the closed position



Locate one of your air conditioner vents and feel the air flow to see if the air is cooling. Check to make sure raw water is being discharged from the boat via the thru hull located on the port side hull nearest the bow. To maintain proper water flow to the air conditioner, check and clean the seawater strainer by unscrewing the bottom clear container.

To turn off the air conditioner, press the on/off button. Once the air conditioner is turned off, you may also turn off the blower switch (if applicable) and the breaker switches for the air conditioner and generator.

The optional air conditioner uses seawater for cooling. The air conditioner seacock is located inside the cabin beneath the mid berth and a strainer is located between the seacock and the cooling (sea water) pump. Do not operate the unit if cooling water is not flowing or the pump will be damaged. If the unit fails to cool, inspect the intake and strainer for blockage. Make sure the seacock is open when in use and closed when not in use.

The seawater cooling system may develop an air lock at high speed or if the boat is removed from the water. An air lock will cause cooling water to fail to flow through the system. Open the strainer to purge air from the system and eliminate the air lock. This should be done each time the boat is put in the water.

To maintain proper water flow to the conditioner, check and clean the seawater strainer by unscrewing the bottom clear container.

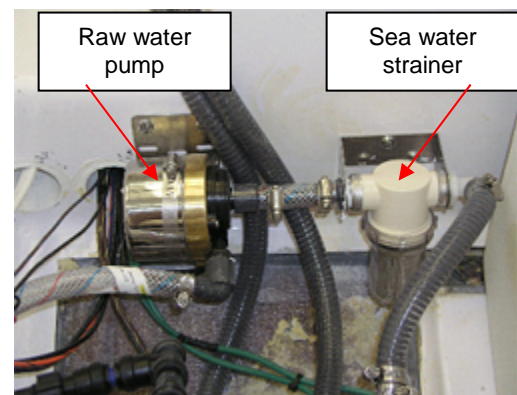

Air Conditioner System

The following is a typical air conditioner installation. Some installations may vary.

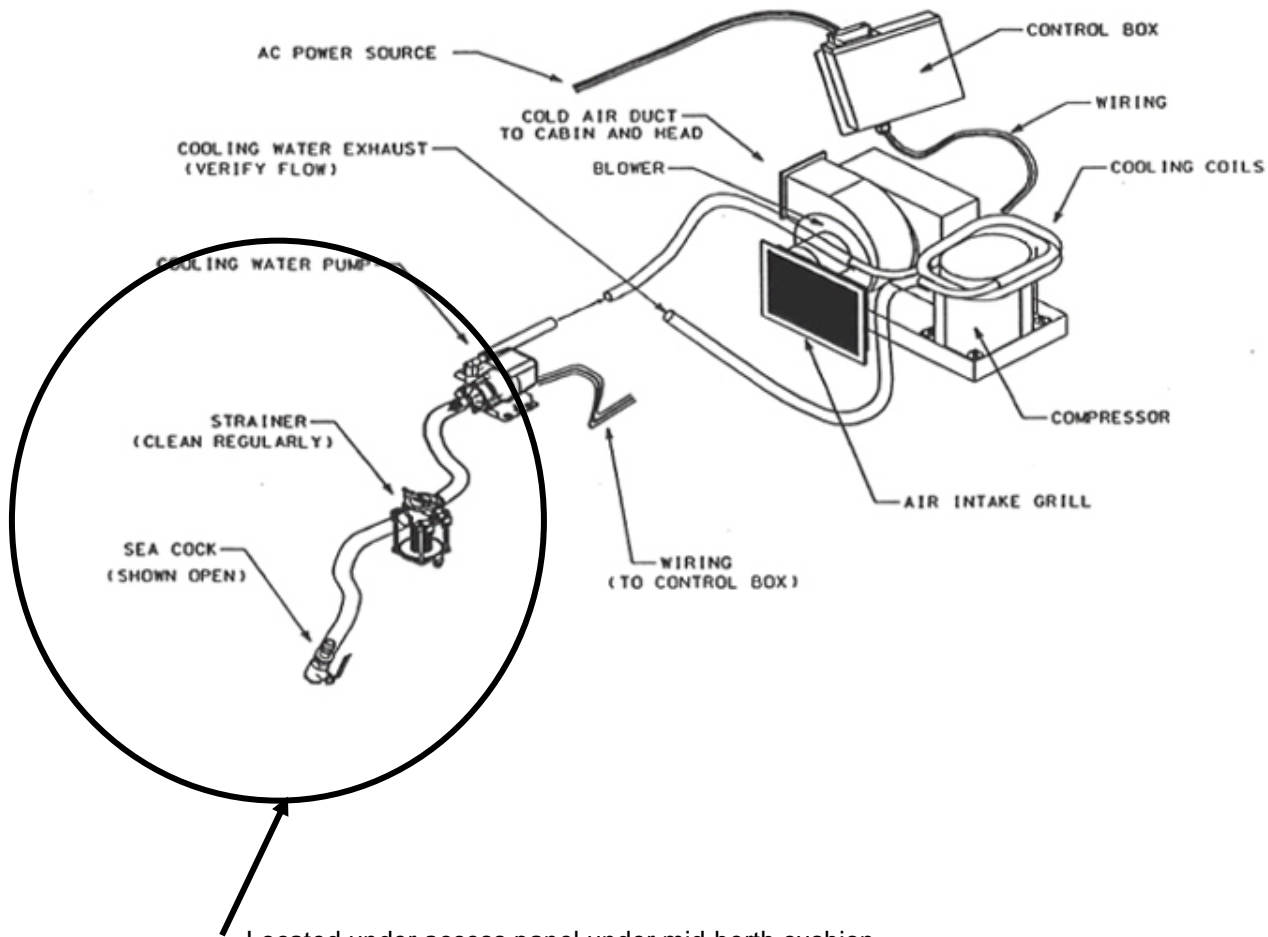

Please refer to the owner's manual provided by the manufacturer of the air conditioning unit for operational procedures and for information related to the care and maintenance of their product. When in doubt, always defer to the air conditioner manufacturer's instructions and/or recommendations.

Note: The manufacturer of the air conditioner provides the limited warranty for the air conditioner and most associated parts. Please refer to their owner's manual and follow their recommendations for scheduled maintenance and service. All service and/or warranty repairs must be performed by a repair facility that is authorized to work on their equipment.

Fresh Water System

Note: There must be fresh water in the fresh water tank in order for the fresh water and shower sump pumps to operate. Operating the pumps with an empty tank could cause serious damage to the pump.

Fresh Water Pump

The fresh water pump is located under the hinged access panel in the mid berth. Locate the fresh water pump switch (labeled cabin water system) and the DC main switch on the AC/DC panel and move both switches to the on position. Next go into the head area and turn on the sink faucet/nozzle to check and see if water is coming out of the faucet/nozzle. Turn off the head sink faucet/nozzle and repeat the same process for the faucet/nozzle at the cabin sink in the galley.

At the transom, the fresh water system transom hose is located behind a white rubber cap/cover. Pull open the cap and pull out the faucet/shower nozzle and hose. Press the button on the nozzle to ensure proper operation (water spraying). This faucet/shower nozzle can also be used at the transom sink. When you are finished, stow away the transom fresh water hose and cover the outlet with the white rubber cap.

If the fresh water system is not in going to be in use, return to the AC/DC Panel in the cabin and turn the cabin water system switch to the off position.

Note: If you should hear a sucking sound, you may have a leak on the inlet side of the fresh water tank. The tank is located under the hinged panel in the mid berth and there are 2 hoses connected to the top of the tank. The larger diameter hose is the water fill hose and the smaller diameter hose is the water vent hose. Inspect the hoses for leaks and make certain that the hose connections are secure.

When you close all of the faucets, the pump will run briefly. If the pump continues to run with all faucets closed, check the system for leaks or have the pump tested.

Fresh Water Tank Fill

This is a stainless steel fitting located amidships on the port gunwale. Twist the cap to open the fitting. The cap is connected to the fitting by a chain or cable so that it will not fall into the water and/or get lost. Use a garden hose to fill the fresh water tank through this fitting. Fill the tank with potable water only.

Fresh Water Tank

The 39 gallon capacity fresh water tank can be filled via the stainless steel fresh water tank fill located on the amidships port gunwale or via the city water hook-up/inlet on the outside of the transom. See the Fresh Water Tank Fill and/or the City Water Hook-Up/Inlet sections below for filling procedures.

The 39-gallon fresh water tank and the fresh water pump are both are located under the hinged hatch in the mid-berth.

Important: Fill the tank with potable water only. Refilling the tank often will help to keep it a source of clean fresh drinking water. Never fill the fresh water tank with anything other than fresh water.

The fresh water pump (not shown in this photo) is located forward of the sump pump.

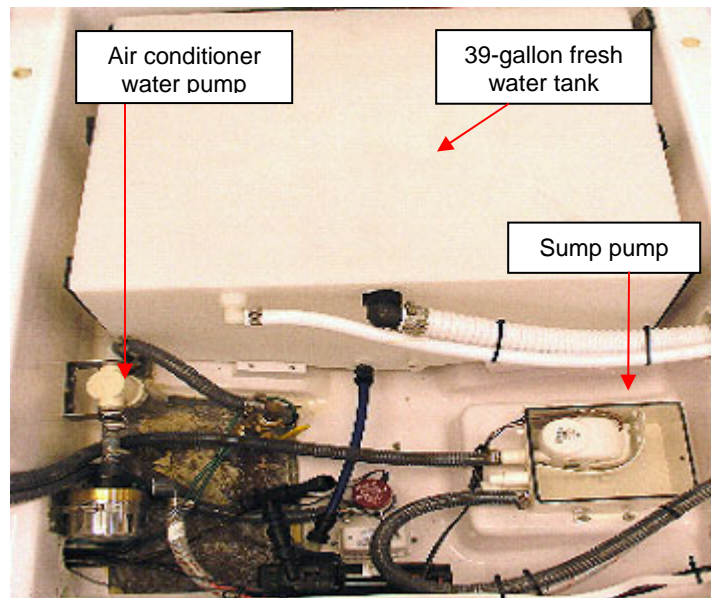

Fresh Water Stations

The boat is equipped with 3 fresh water stations: the main cabin sink in the galley, the head sink and/or shower and the transom shower

Turn on the cabin water system switch located on the AC/DC Panel to blow out any air that may be trapped in the water lines. When you turn on any of the faucets, you will hear the pump run.

Fresh Water Faucet in Main Cabin (Hot and Cold)

The fresh water faucet for the main cabin is a lever style faucet and is located at the galley sink. See the section titled Fresh Water Pump for operating instructions before using this faucet.

Fresh Water Faucet with Pull Out Shower in Head (Hot and Cold)

The fresh water faucet with pull out shower is located at the head sink and the faucet/nozzle has dual control knobs for hot and cold water. When doubling as a showerhead, pull the faucet/nozzle from the sink and place it in

the fitting on the forward head wall. See the section titled Fresh Water Pump for operating instructions before using this faucet/nozzle.

Fresh Faucet Water with Pull Out Shower at Transom

The fresh water faucet with pull out shower is located at the transom sink and is covered with a white cap. Pull open the cap and pull out the shower nozzle and hose. See the section titled Fresh Water Pump for operating instructions before using this shower.



City Water Hook-Up/Inlet

This fitting is located on the outside of the transom, on the port side of the dive platform. Twist the cap to open the fitting and then connect to your marina's water supply outlet. Fill the fresh water system with potable water only.

Shower System and Shower Sump Pump

The shower sump pump is used to pump out any gray water (used water) from the system. The pump is located inside the cabin and is accessible through the mid-berth access hatch under the mattress. Water from the sink and floor drains, in the head area, is pumped out via this system.

Under normal operations, as water drains out through the sink and shower drains, the float switch activates the pump and allows the gray water to be pumped overboard.

To operate the shower system and the sump pump, go to the AC/DC panel in the cabin, locate the DC main, sump pump and cabin fresh water switches and move them all to the on position. Visually inspect the sump pump to ensure it is properly secured and listen to hear the pump running.

Turn all switches (cabin water system pump, sump pump and the DC main) back to the off position once you have finished using the sump pump system.

Water Heater

The 6-gallon capacity water heater is located in the cabin behind the port wall in the mid berth. It is best accessible by removing the tackle station in the aft cockpit. A photo showing the water heater, head overboard/discharge pump, VacuFlush head holding tank and VacuFlush generator pump can be seen in the Vacuum Flush with Dockside Discharge section of the manual.

To operate the water heater, locate the water heater and the AC main switches on the AC/DC panel and turn them both to the on position. Allow the water heater pump to operate for a couple of minutes then turn on the hot water faucet in either the galley or the head. When finished, turn off all the water faucets along with the water heater and DC main switches on the AC/DC panel.

Head Waste System

WHAT IS THE LAW? Congress enacted the Clean Water Act of 1972 (amended in 1987). This law addresses a wide spectrum of water pollution problems, including marine sewage from boats in navigable U.S. waters including coastal waters up to three miles offshore. The law further provides for "no discharge" by boats operated in enclosed lakes and reservoirs or in rivers not capable of interstate navigation. States may apply to the EPA to have certain other waters declared "no discharge zones" if discharge of treated sewage would be harmful. In short, boats with installed toilets must have an operable Coast Guard approved Marine Sanitation Device (MSD) designed to either hold sewage for pump out ashore or for discharge in the ocean beyond the three mile limit, or to treat the sewage to Federal standards prior to discharge.

All boats built since 1977 with installed toilets must have an operable approved type I, II or III MSD. Since 1980, all boats (including those built before 1977) with installed toilets must have an operable MSD. Both the U.S. Coast Guard and the Natural Resources Police can enforce MSD requirements.

Check with your local authorities, Coast Guard, local marina or your dealer for the rules and/or laws that may apply specifically in your area.

Vacuum Flush with Overboard and Dockside Discharge

Your Pro-Line is equipped with a VacuFlush head system that offers the ability to use either overboard or dockside discharge. To operate or test the system, make sure that your fresh water tank is full of water. Make sure that the DC main, cabin freshwater system, and head switches on the AC/DC panel are all in the on position. To flush the VacuFlush head system, use your foot to depress the pedal at the base of the head. This action will pump fresh water into the stool, empty the head and transfer all waste into the waste tank. When you release the pedal, water will stop entering the stool and the flushing action will cease.

You can check the waste level in the waste tank by monitoring the lights on the Tank Watch 4 panel, which is located next to the AC/DC panel. As waste enters the tank, the lights will change to indicate the waste level (i.e., green for empty, yellow for low, orange for mid level, red for full).

Your boat is equipped to offer you the option of using overboard or dockside discharge to pump out the waste tank. Before using the overboard discharge system, be sure to check with your local authorities, Coast Guard, local marina or your dealer for the rules and/or laws that may apply specifically in your area.

Overboard Discharge - To operate the system, first make sure that the DC main, cabin freshwater system, DC macerator and head switches on the AC/DC panel are all in the on position. Then, turn the key on the Tank Master 4 panel to the automatic position. The green light will come on indicating that the system is working and waste will begin pumping overboard via one of the thru hulls located amidships on the side of the hull.



Once the tank level reaches the low level in the tank, the green light will go out and the system will turn off. You will need to turn the key to the manual position to complete the pump out process.

If the system does not seem to be pumping properly (water should shoot out approx. 10 feet via the thru hull), check for leaks, loose clamps, etc. For access to check for leaks:

- Remove the tackle box and frame by removing only the top 2 and bottom 2 screws of the tackle box. The other 4 screws hold the frame to the tackle box. Check the hose connections to be sure that there is no leak.
- Lift the hinged hatch on the bottom of the mid berth and check the fittings and/or clamps on the pump.

Refer to the manual in your owner's packet supplied by the manufacturer of the VacuFlush system for specific operating instructions.

Dockside Discharge – When at a marina that offers dockside discharge, the marina will provide the facilities needed to perform this operation. You will not need to use the Tank Watch system. The stainless steel fitting labeled waste is located amidships on the port gunwale. Twist the cap to open the fitting and insert the hose provided by the marina into the dockside discharge waste outlet to connect to your marina's dockside service facilities. Follow the instructions provided by the marina to operate their equipment.

Head Macerator Pump

The head macerator pump is located in the cabin behind the port wall in the mid berth. It is best accessible by removing the tackle station in the aft cockpit. To operate the macerator pump, locate the DC main, cabin water system and the head switches on the AC/DC panel inside the cabin. Turn all 3 switches to the on position and go into the head area. Press the pedal on the side of the electric head to fill the toilet bowl and empty the contents. This flushes the contents of the head into the holding tank. When the system is not in use, turn all 3 switches to the off position at the AC/DC panel.

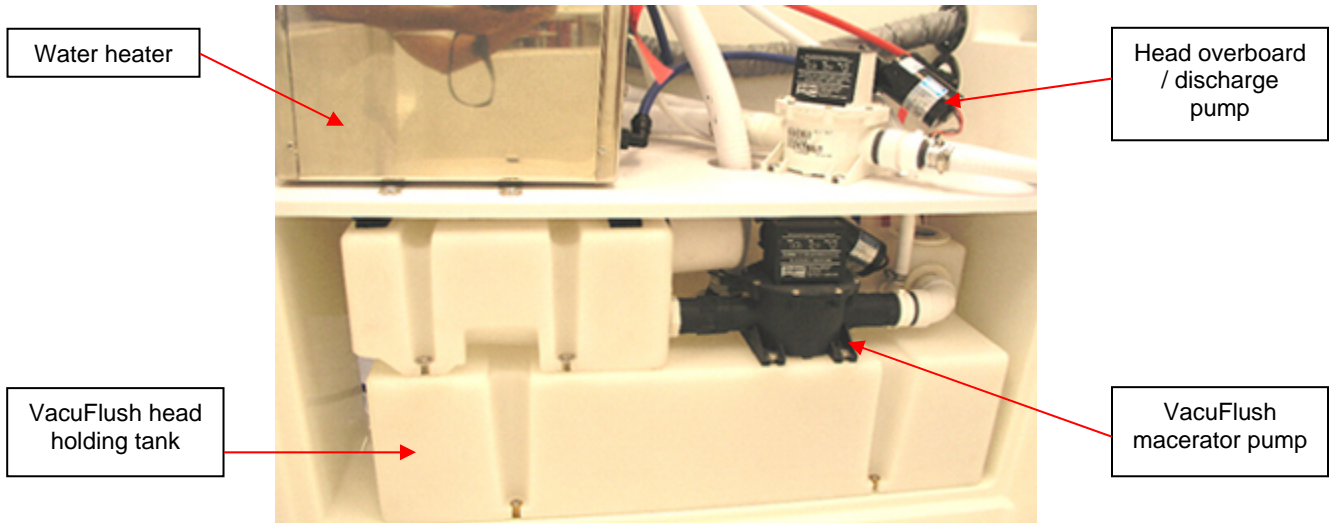

Note: There must be fresh water in the fresh water holding tank in order for the head macerator pump to operate and properly flush the system. Operating the pump with an empty tank could cause serious damage to the pump.

Warning: Waste in the holding tank can form methane, an explosive gas. Use suitable precautions when any maintenance is done to the sanitary system.

Sea Water System

Bilge Pumps

The boat is equipped with three (3) bilge pumps, therefore, there are 3 bilge pump switches to choose from on the switch panel. The locations of the three (3) bilge pumps and the labeling of the bilge pump switches are as follows:

- Bilge 1 - This 1100 gph bilge pump is located in the bilge and is installed as far aft as possible. If your vessel is equipped with an optional generator, this pump will be located under the generator but is still reachable.
- Bilge 2 - This 1500 gph bilge pump is located just forward of the 1100 gph bilge pump and is quite visible.
- Fwd Bilge - This 1100 gph pump can be accessed via the hinged panel under the mattress in the mid berth and is very accessible.

Depressing the applicable bilge pump switch (Bilge 1, Bilge 2 or Fwd) to the up or forward position activates the corresponding bilge pump.

There are 2 steps in properly checking the bilge pumps. First, turn the on bilge pump at the instrument panel by pressing the applicable bilge pump switch to the on or forward position. When the bilge pump switch is in the on position, the switch light should be illuminated. To check and see if the bilge pump is operating, open the hatch over the applicable bilge pump and listen to hear the bilge pump running.

Bilge pump 2
(Bilge pump 1 is under the optional generator)



Forward bilge pump with float switch



Second, turn the bilge pump off at the instrument panel and check the bilge pump float switch. Each pump is equipped with an automatic float switch (white box) that is mounted next to the bilge pump. As long as your boat is equipped with an operable battery, each pump will operate independently when water is present in the area.

Each float switch is equipped with two plastic knobs located on either side of the switch. Turn either one of the knobs to raise the float to engage the bilge pump. If the pump comes on, the automatic float is operating properly. It is recommended that you check the operation of each automatic float switch monthly.

Keep the bilge area clean and free from debris that could clog ports or inhibit float movement. Also, keep the battery (starboard) that provides power to the bilge pumps charged. If the battery is not charged and flooding occurs, the boat could swamp causing damage and possible loss of life or property.

If for some reason the indicator light on your bilge pump switch comes on, check your bilge for water. It is not uncommon for rain water or water from washing your boat to accumulate in the bilge. Standing water will activate the automatic float that is connected to the bilge pump. If you notice your pump running frequently during your day on the water, you should check the thru hull fittings, hose connections, etc. for any possible leaks.

High Water Alarm

A high water alarm switch is mounted on the console and is wired to bilge pump 2. The switch should be kept in the auto alarm position (to the left). When the automatic float switch activates bilge pump 2, the alarm will sound. If the alarm should sound, as a precaution, check the bilge area immediately to determine if emergency action should be taken. The toggle switch may be turned to the override position (to the right) to deactivate the alarm.



Baitwell Pump

The baitwell switch at the helm controls the baitwell pump (1100 gph), which is mounted on a seacock in the bilge area. The baitwell pump and seacock are accessible through the bilge hatch. Raw water for the baitwell tub comes through the seacock, to the baitwell pump and then to the baitwell tub.

Before turning the pump on from the helm, check to be sure that the seacock is open. The seacock is wide open when the yellow seacock lever is vertical. When the yellow seacock lever is horizontal, the seacock is closed. The seacock should remain closed when the baitwell pump is not in use.

In the photo to the right, the baitwell pump is shown with the seacock in the closed position. The hose on the lower port feeds raw water to the washdown pump.

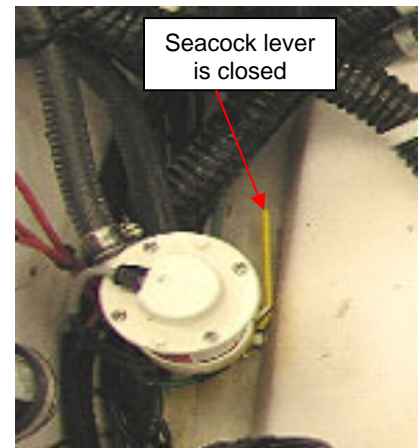

To operate the baitwell pump, locate the baitwell switch on the console and press the switch to the forward position to turn on the pump. When the baitwell pump is operating, go to the baitwell tub, open the baitwell lid and visually check to see if water is pumping into the tub through the aerator fitting. This will ensure that the baitwell pump is working properly. The hose that goes from the baitwell pump to the baitwell tub is routed behind the starboard aft wall of the mid berth.



To turn the baitwell pump off, press the baitwell switch to the aft position. You should always turn the baitwell switch off at the helm if the pump is not going to be used soon.

The 25 gallon capacity baitwell tub is located aft of the helm seat. It comes equipped with an aerator head, 2 overflow drains that allow circulation to keep bait alive, a plug for the drain and a baitwell light.

In addition to the baitwell tub, the bait station includes a sink, raw water washdown, grab rail and areas to hold a bar of soap, knife and pliers

If you find it necessary to run the baitwell pump while you are underway, you may be forcing more water than necessary up through the seacock. In this instance, adjust the seacock lever to a 45 degree angle so that the seacock is only halfway open. The seacock lever may require additional adjustments to find a setting that works best for you.

Even when the baitwell pump is turned off, if the seacock is open, the baitwell tub will continue to fill with water while you are underway.

Note: Boats that are equipped with an optional generator and/or air conditioner will have additional brass seacocks and a strainer installed in the aft (generator) and mid-ship (air conditioner) bilges to filter seawater. These seacocks should be closed when the generator and/or air conditioner are not in use.

Washdown Pump and Raw Water Washdown Hose

The washdown pump is mounted on the aft starboard stringer and is equipped with a pressure switch. This pump shares the same seacock with the baitwell pump and is accessible via the bilge hatch.

To turn on the washdown pump, locate the washdown switch on the instrument panel and press the switch to the forward position. If you turn on the washdown pump switch and you do not feel pressure, the seacock may not be open. Verify that the seacock is open and depress the switch again. When not in use, the washdown switch should be left in the off (down or aft) position.

Note: Before operating the washdown pump, make sure that the seacock at the baitwell pump is in the open position before turning on the pump. The seacock is wide open when the seacock lever is in the vertical position. When the seacock lever is in the horizontal position, the seacock is closed. The seacock should remain closed when the baitwell or washdown pumps are not in use.



The raw water washdown hose is located in a compartment below the bait station sink. When the washdown pump is on, twist the nozzle on the end of the hose to turn the water on and off and check to see if the washdown sprays. You can adjust the pressure or stream of the spray by turning the nozzle clockwise for a tighter stream or counterclockwise for more of a spray pattern. This spray nozzle can also be used at the freshwater sink located next to the baitwell tub.



After checking for water and before returning the washdown hose to the storage compartment, turn off the washdown pump at the helm to release the water pressure in the hose. Twisting the hose clockwise allows you to easily stow the hose away.

The round filter attached to the side of the washdown pump should be removed and cleaned often with running water.

Fish Boxes with Macerator Pump

Your boat is equipped with port and starboard fish boxes with a total capacity of 125 gallons. The 5.0 macerator pump drains both fish boxes and/or macerates any fish particles. The pump is located in the bilge and is equipped with an automatic float switch. As the fish boxes drain, water and/or debris travel to the holding tank attached to the pump and then to the fish box macerator pump which pumps the water and/or debris overboard.



The fish box macerator pump operates on a 2-way rocker switch located on the switch panel labeled fish box. To properly operate the fish box macerator pump, fill both fish boxes with water. Then move the fish box switch on the switch panel to the forward position to operate the pump. The water and fish particles will be pumped out of the tubs and will be routed through the macerator pump and then overboard via the fish box thru hulls on each side of the boat. When you are finished emptying the fish boxes, place the fish box switch in the aft position to turn off the fish box macerator pump.

To check the system for drainage, remove the white 90-degree elbow fitting that connects the hose to the holding tank. The fitting is held in place with a rubber grommet therefore no hose clamps need to be removed. After removing the fitting, feel around just inside the holding tank for the 2 round plastic buttons (approx. ½" in diameter) and simply lift the 2 buttons to check the operation. If the float is working properly, the pump will activate. On occasion, you may find excessive debris in the holding tank that is causing a blockage. Just remove the debris through this same opening. When you are finished checking the operation, reinsert the 90-degree elbow fitting back into the rubber grommet until it seats itself.

Storage, Hatches, Windows and Doors

Storage

Your boats come with plenty of storage areas:

- Tackle Box
- Fire extinguisher holder
- Below the cockpit lounge seat
- Below the Forward V berth
- Tub below the rear facing aft jump seat
- SS Drink holders
- Small closet in the main salon
- Cabinets, storage compartments and shelves (some with cargo nets) are located throughout the cabin

Rod Storage

Rod holder storage areas are located throughout the boat. Horizontal rod racks are installed on each side of the aft cockpit with the capacity to store 4 rods and reels. There are 2 pairs of rod holders (vertical) with inserts installed in the gunwales

If you have selected the optional hard top, there are 4 additional rod holders installed on the optional hard frame. In addition, there is the option of ordering the hard top with the optional outriggers.

Tackle Box

The tackle box is located in the cockpit aft of the lounge seat. The box is equipped with 4 trays for storing your small fishing tackle equipment.



Hatches and Latches

The fiberglass deck hatches for the anchor locker, bilge and the 2 fish boxes are made of fiberglass and can easily withstand the weight of passengers and gear; just like the rest of the deck surfaces.

The twist latches that are installed on the fiberglass deck hatches are made of stainless steel. Just lift the handle of the latch from the recessed area of the hatch, twist it and lift the hatch open. Make sure that all hatches are closed and secured before you get underway. Lift the handle of the latch, turn it 180 degrees so that the latch catches and return the handle to the recessed area of the hatch.

The hatches for the bilge and fish boxes are each equipped with gas shocks. The gas shocks allow you to easily open and close the hatches. The gas shocks also hold the hatches in place when they are open.

The following photo identifies the locations of the components that can be accessed via the access hatches.

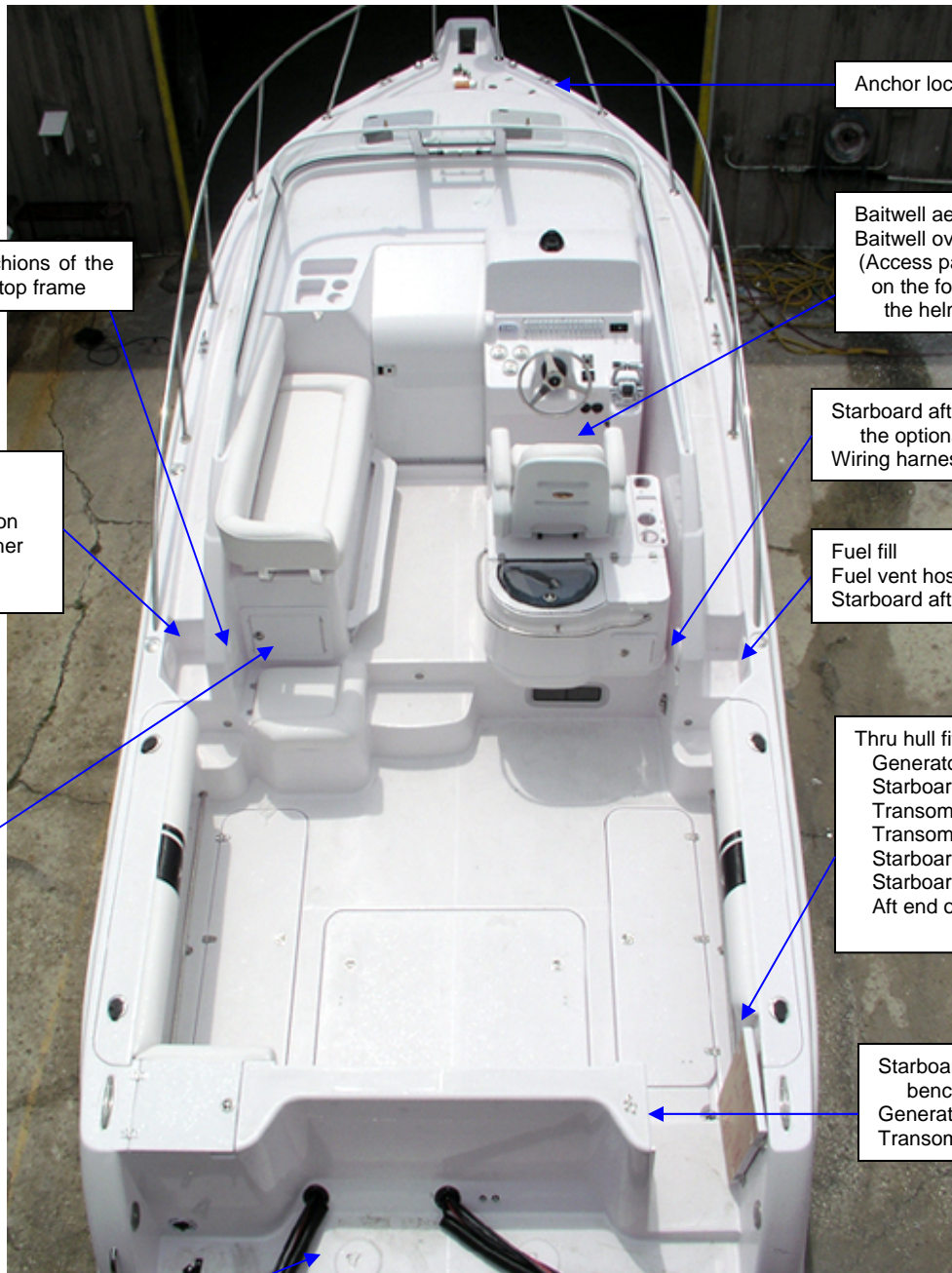

Anchor locker

Baitwell aerator head
Baitwell over flow drains
(Access panel is installed on the forward edge of the helm seat base)

Port aft stanchions of the optional hard top frame

Starboard aft stanchions of the optional hard top frame
Wiring harness

Fresh water fill
Fresh water vent
Port aft bow rail stanchion
(Behind fire extinguisher holder)

Fuel fill
Fuel vent hose
Starboard aft bow rail stanchion

Water heater
Head system
(Behind tackle station)

Thru hull fittings for
Generator
Starboard inboard deck drains,
Transom door hinge
Transom door magnet
Starboard aft cleat
Starboard aft rod holder
Aft end of starboard toe rail.

Starboard side of the aft folding bench seat
Generator exhaust hose
Transom door catch

Port thru bolt for the motor bracket and starboard engine primer bulb (2 stroke engines only)

Starboard thru bolt for the motor bracket and starboard engine primer bulb (2 stroke engines only)

Windshield – Tempered Glass with Vent

The windshield assembly is constructed of white powder coated aluminum and tempered glass. The windshield vent in the center of the windshield assembly can be opened and closed to allow air circulation at the helm. The switch that operates the windshield vent is a 3 position momentary switch, which is only active when the button is depressed.



To open the windshield vent, depress and hold the switch in the up or forward position. Release the switch when the windshield vent reaches the desired position. When you are ready to close the windshield vent, depress the switch in the down position until the windshield vent has closed or reached the desired position. Once the vent has traveled to the full out or full in position, you should release the switch.

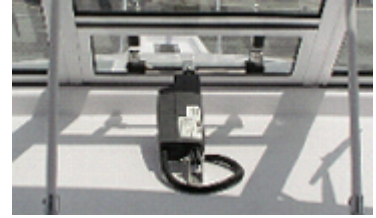

Windshield Wipers

Depressing the switch to the up or forward position activates the starboard wiper. Depressing the 3-position switch to the down or aft position will activate both the port and starboard wipers. The center position on the switch is the off position for both wipers. If at all possible you should try never to run the wipers on a dry windshield. This will dramatically reduce the life of your wiper blades.

Windows

To allow for proper ventilation, 3 styles of windows have been installed throughout the cabin.

Mid Berth Cabin Window - A window is installed in the mid berth cabin and is hinged at the top. To open the window, turn the 3 latches to the horizontal position and lift the window open. To close the window, rotate the hinged window back into the closed position and turn the 3 latches back to the vertical position to secure the window.



Cabin Hatches - A pair of cabin hatches complete with screens is installed in the ceiling of the main cabin. To open the window, remove the screen, turn both levers forward and push the hatch open to the desired position. To hold the hatch in place, tighten the black plastic cylinders on both of the mounting arms. Then replace the screens. DO NOT allow passengers to sit or stand on the hatches as they could break the hatches. The hatches should be in the closed and latched position when the vessel is underway.



Cabin Portholes - Two portholes complete with screens are installed in the main cabin. One is located in the galley and the other is located in the head. To open the porthole window, loosen the 3 star nuts by turning them in a counter clockwise direction. Then, rotate each of the star nuts down (away from the plastic window); the window is hinged at the top. Once the star nuts are out of the way, lift the window open and away from the frame by carefully pulling on the phalanges at the bottom of the window.

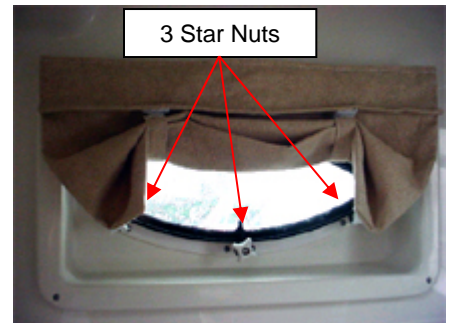

When finished, close the window, rotate each of the star nuts back into place and turn the star nuts in a clockwise direction to secure the window.

Transom Door

The transom door is located on the starboard aft corner of the boat. The sliding bolt style latch secures the door in the closed position. To open the door, slide the latch starboard (to the left from inside the cockpit).

The transom door should always remain closed while underway. When the boat is anchored, the transom door can be held open by the magnetic locking mechanism mounted on the starboard aft freeboard. To close the door, pull the door firmly to release the magnet and move the door to the closed position. To door latch will engage automatically.



See the Service and Care section of this manual for cleaning recommendations.

Cabin / Companionway Door

The acrylic cabin door is equipped with a locking latch, doorstop and a slide mechanism. To open the door, just press the black latch on the latch assembly to the right and slide the cabin door to the starboard side. To close the door, slide the door back to the port side and the latch will engage itself.

The stainless steel doorstop at the bottom of the doorframe can be utilized to keep the door from sliding shut when you are underway or anchored. When using the doorstop, take notice of the prevailing seas. The door should never remain open when you are underway or when conditions might cause a passenger to lose their balance and accidentally fall through the doorway.

The lock comes with a set of two numbered keys. We recommend that you make note of the key number and keep it in a safe place. In the event that you need to replace the keys, this will allow you to replace just the keys and not the entire lock assembly.

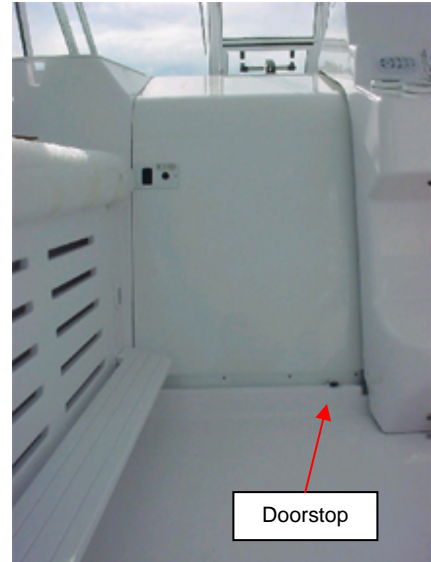

See the Service and Care section of this manual for cleaning recommendations.

Hardware

Cleats

Your boat is equipped with 2 pop-up and 5 standard cleats. They are installed to provide areas to permit you to tie off the boat at dockside, tie off to another boat that is anchored, secure bumpers/fenders, and/or tie off the anchor (when dropped) to prevent the line from pulling on the windlass, etc. You should never use the cleats for towing another boat or skier.

Bow Rail

The bow rail is constructed of stainless steel. The railing, which is through bolted to the gunwale, is provided for safety. Never use the bow rail to tie off to anything heavier than a bumper/fender. Do not use the bow rail for anchoring, or to tie off to the dock or another boat. Do not use the bow rail to tow another boat or skier. Never stand on the bow rail or use it as leverage when pulling up an anchor, a fish or any other objects. Do not use the bow rail to tie off and/or secure a large catch, etc.

Grab Rails

A set of 4 stainless steel grab rails has been installed to provide safe boarding and navigation on the boat. They are located at the port transom ladder, around the baitwell station, on the port side cabin wall as you step down into the cabin and on the forward wall of the head.

Gunwale Trim / Rubrail

A white rigid vinyl gunwale trim with a stainless steel insert is installed at the juncture of the deck and hull. This durable trim provides a nice clean look and serves as somewhat of a cushion when you are docking, coming along side another vessel, etc.

See the Service and Care section of this manual for cleaning recommendations.

Thru Hull Fittings

Thru hull fittings provide overboard drainage. The following photos indicate the source of drainage for each of the thru hulls.

Port Side



Starboard Side

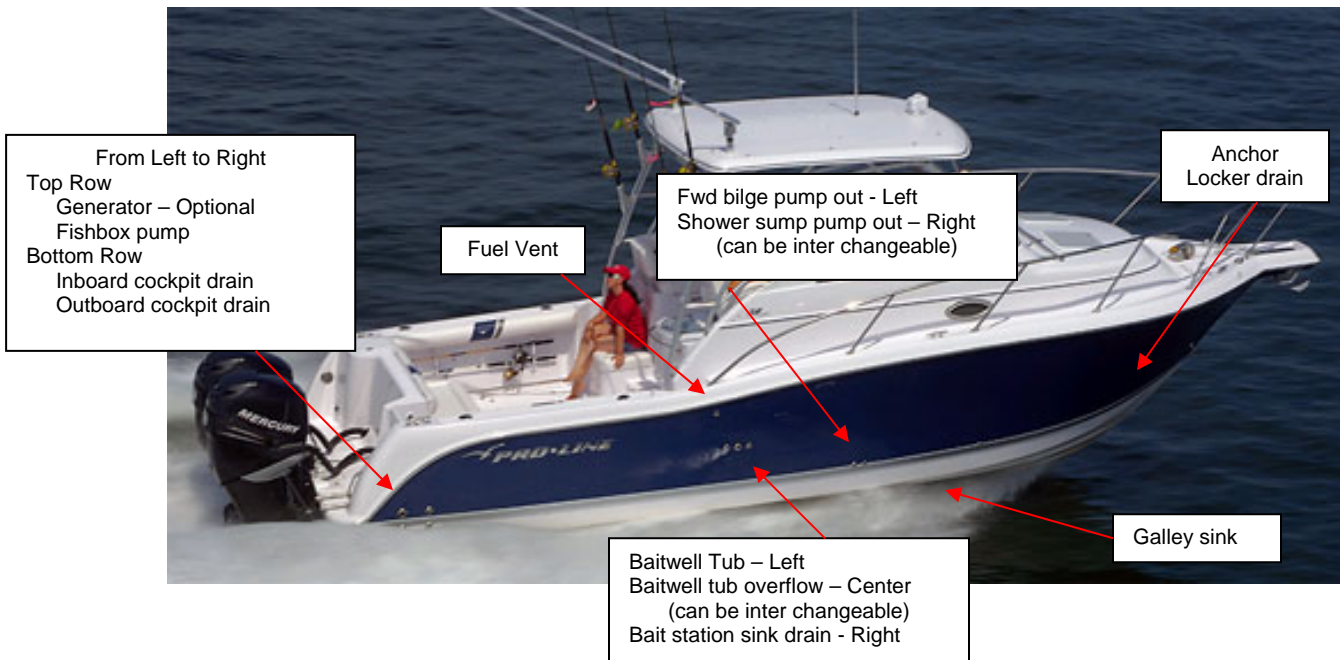

Drain Plug

Before launching the boat, always make sure that the drain plug has been installed in the fitting on the transom at the keel. If your boat is being transported, remove the drain plug once the boat is secured on the trailer so that any excess water can be drained via the fitting. Never remove the drain plug when the boat is sitting static in the water.

If you live in an area where it snows and you are storing your boat on a lift during the winter, make sure that you remove the drain plug. When the snow melts, if the float switch for the bilge pump happens to fail, it could flood the bilge and damage electrical components in the bilge.

Cockpit / Deck Drains

There are four (4) cockpit/deck drains in the aft area of the cockpit that allow excess water in the cockpit to drain overboard via thru hulls on each side of the boat. To ensure that there is no blockage in any of the hoses connected to the drains, it is recommended that you occasionally run water through each of the cockpit drains and visually inspect the thru hulls to verify that water flows freely and that there is no blockage. To trouble shoot, check the hoses for leaks and make certain that all hose connections are secure.



Bow Pulpit with Anchor Roller and Rope Locker Storage

We have installed an aluminum anchor roller with built in bow protector at the bow pulpit. The anchor line is secured inside the anchor locker and is then routed through the windlass and anchor roller. The anchor (not included as standard equipment) is held on the line beneath the bow pulpit. This allows you to move about the bow area safely without tripping over the line or anchor.

Bow pulpit with anchor roller



Rope locker storage



Dive Platform - Integrated with Ladder

An integrated Euro style dive platform is built into the fiberglass construction of the deck and hull and includes a stainless steel dive ladder on the starboard side of the transom. With the engines tilted down, passengers can move easily through the transom door and across the large dive platform for safe access to the dive ladder.

An optional ladder can be installed on the port side of the dive platform to allow additional boarding capability. When factory installed, this option includes the installation of an additional grab rail on the starboard transom.



Cabin Appliances and Accessories

Your galley comes equipped with an alcohol/electric stove, microwave and a direct current refrigerator. In addition, the optional electronics equipment listed below is available for installation in the main cabin:

- Stereo - AM/FM CD with 4 Speakers and Remote
- Stereo - AM/FM CD with Upgraded Speakers, Woofer and Amplifier
- Stereo - XM Upgrade
- Television (Flat Screen) with DVD Player (includes Cable Outlet)

Note: The individual manufacturers of each of the following products listed in this section provide the limited warranties for their equipment and most associated parts. Each manufacturer provides recommendations regarding service and warranty related issues. In many cases, service and/or warranty repairs must be performed by a repair facility that is authorized to work on their equipment.

Please refer to the owner's manuals provided by the manufacturers of the any equipment listed in this section for operational procedures and for information related to the care and maintenance of their products. When in doubt, always defer to the television manufacturers' instructions and/or recommendations.

Based upon the availability from our vendors, the equipment listed in this section may change from time to time. Therefore, we request that you refer to the owner's manuals provided by the manufacturers of the equipment for operational procedures and for information related to the care and maintenance of their products.

Alcohol / Electric Stove

Before attempting to use the alcohol/electric stove, please refer to the owner's manual provided by the manufacturer of the stove for operational procedures and for information related to the care and maintenance of their product. When in doubt, always defer to stove manufacturer's instructions and/or recommendations.

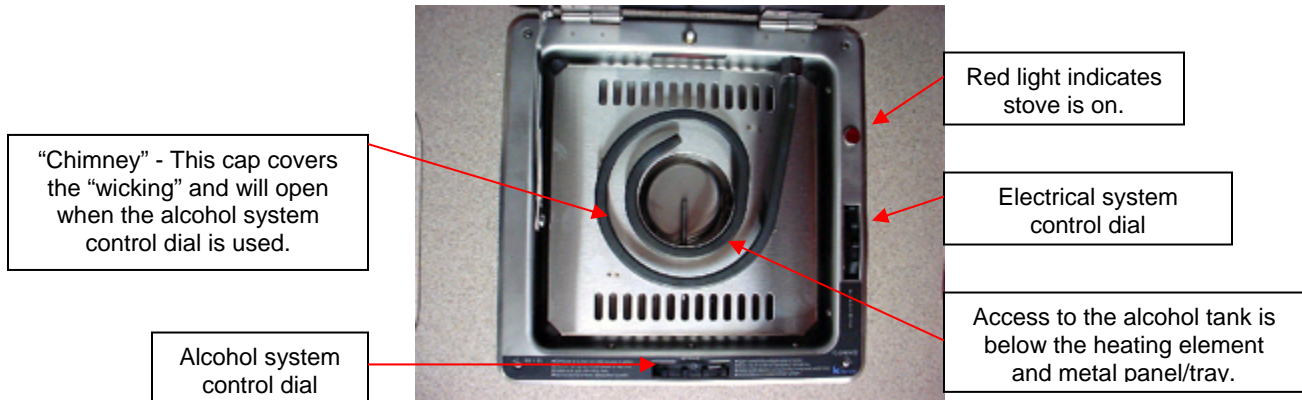

Do Not attempt to cook on top of the glass lid.

Do Not close the glass lid until the stove has cooled completely.

To Operate the Stove Using the Electrical System

- Locate the stove switch and AC main switch on the AC/DC panel in the cabin and turn both of these switches to the on position.
- Locate the stove dial on the side of the stove and rotate the dial to the desired cooling/heating level.
- The red led light will come on indicating that the stove is working properly.
- When finished, rotate the dial back to "O" to turn the stove off.

To Operate the Stove Using the Alcohol System

- Lift and rotate the heating element to the right until it is in a vertical position.
- Remove the metal panel/tray that is installed under the heating element.
- Turn the quarter size metal knob on the top of the stove counter clockwise to access the alcohol tank.
- Add a maximum of 6 ounces of fuel; just enough to cover the wicking. Use alcohol stove fuel only (denatured ethyl alcohol).
- Replace the quarter size metal knob turning it clockwise.
- Replace the metal panel/tray.
- Rotate and lower the heating element and press to snap it back into place.
- Locate the Alcohol dial on the front of the stove and turn it to the left to its highest setting. This also opens the chimney in the center of the stove.
- Apply a match or lighter to the chimney to light the stove. Then, adjust the dial to the desired setting.
- When finished, rotate the dial to the right (back to "O") to turn the stove off.

Microwave

Please refer to the owner's manual provided by the manufacturer of the microwave for operational procedures and for information related to the care and maintenance of their product. When in doubt, always defer to the microwave manufacturer's instructions and/or recommendations.

Note: The microwave receptacle is located behind the refrigerator.

Refrigerator

The DC refrigerator is located in the galley. There is a latch located on the left side of the refrigerator door that secures the door. To open the refrigerator door, slide the latch to the left. Slide the latch back to the right to hold the door securely in place when the door is closed.

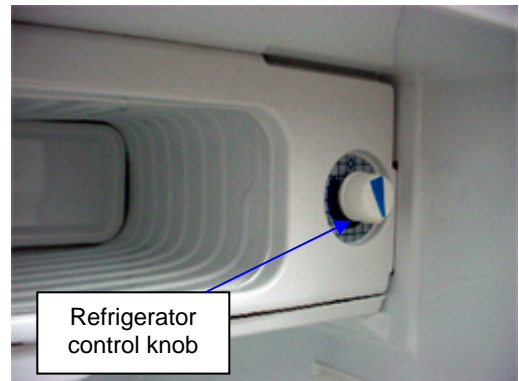
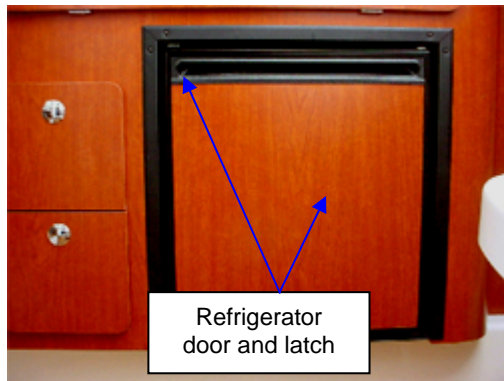

To operate the refrigerator, locate the refrigerator and DC main switches on the AC/DC panel inside the cabin and turn both switches on. The control knob located inside the refrigerator allows you to set the refrigerator at the desired temperature level. When you are not using the appliance, all switches should be in the off position.

Flat Screen Television with DVD Player and Cable Outlet (Optional)

The combined flat screen television and DVD player is mounted over the V berth on the forward cabin wall. When this option is factory installed, a cable outlet is also included and is installed next to the outlet for shore power. Twist the cap on the fitting and lift the cap to gain access to the outlet. Then, plug the cable source from shore into the outlet.



AM/FM Stereo with CD Player, Speakers and Remote (Optional)

The AM/FM stereo comes equipped with a CD player, remote and 4 speakers. The stereo can be operated from within the cabin or remotely from the console and is powered by the dealer-installed batteries. The installation locations are as follows:



- AM/FM Stereo with CD Player – Installed on the galley wall
- Remote - On the console
- Speakers - Two speakers at the forward V berth and two in the cockpit.
 - If you have selected the optional hard top, the cockpit speakers will be installed on the face of the built in storage box.
 - If you have not selected the optional hard top, the cockpit speakers will be installed on the wings located on each side of the cockpit.

XM Stereo Upgrade (Optional)

The controller head unit (XM box) is located behind the AC/DC panel in the cabin. When activating your satellite service, your service provider will request that you provide them with the "Radio ID #". You will find this 8 character ID # (alpha numeric) on the face of the XM box.

8 character (alpha numeric) "Radio ID #"



Upgraded Stereo Package (Optional)

This upgraded stereo package adds the following electronics to the already standard AM/FM stereo with CD player and remote: upgraded speakers, woofer and amplifier.

Cabin Interior

Countertops and Sinks

Head – The sink and countertop in the head area are made of the same gelcoat covered fiberglass that is used in the construction of the deck and hull of the boat. For information on keeping the sink and countertop in the head area looking like new, please refer to the Gelcoat and Fiberglass areas in the Service and Care section of this manual.



Note: Do not place curling irons or other hot materials on this fiberglass countertop as this surface could melt or burn.

Galley - The countertop in the galley is made of Corian®. Corian® was created for a lifetime of easy care. Stains, mold, mildew and bacteria cannot penetrate the surface because the countertop material is non-porous. Corian® also resists burns and scratches. Just follow their guidelines to keep your Corian® surfaces looking as fresh as the day they were installed.

The sink in the galley is made of Staron® 100% acrylic solid surface and is supplied by Samsung. It is resistant to chemicals, fungus and bacterial growth and heat. Staron® is practical and easy to maintain. If the surface is ever scratched, it is easily repaired with a mild abrasive cleanser or a light-duty kitchen-scrubbing pad. This product is nonporous with smooth, impenetrable seams, so germs and dirt have nowhere to accumulate.

For information on keeping the countertop and sink looking like new, please refer to the Service and Care section of this manual, visit either of the manufacturer's websites (www.corian.com or www.staron.com) or refer to the information in your owner's packet that was provided by the manufacturers of the countertops or sinks. As always, when in doubt, defer to the information provided by the manufacturer (Corian® and/or Staron®/Samsung).

Cabin Floors

The cabin flooring is constructed of the same gelcoat covered fiberglass that is used in the construction of the deck and hull of the boat. For information on keeping the flooring looking like new, please refer to the Gelcoat and Fiberglass areas in the Service and Care section of this manual.

Wood Grain - Laminated – (Optional)

In the main cabin, the flooring is covered with laminated wood grain flooring in cherry and mahogany.

Teak and Holly with Cabin Steps (Optional)

The optional teak and holly flooring is coated with a lacquer finish and makes perfectly compliments the wood upgrade cabin interior.

See the Service and Care section of this manual for cleaning recommendations for the optional flooring products.

Upholstery

Cabin interiors are outfitted in your choice of patterns and the rest of the cabin is decorated with coordinating pillows, curtains and bolsters.

Patterns available for boats built in early model year 2009 are outfitted in your choice of Geometric Spice or Cosmic Caribbean.

Cabin interiors for boats built later in the 2009 model year are outfitted in your choice of Kioske, Milky Way or Riddle.

Please see the Service and Care section of this manual for information on how to clean and care for your cabin cushions, pillows vinyl upholstery.

2007 CABIN INTERIOR GEOMETRIC SPICE



GEOMETRIC SPICE - DELUXE
28 & 32 Cabins
 Invite Spice:
 V-Berth cushions
 Welt in berth bolsters and dinette seat back
 2 pillows
 Shadow Box Antique:
 Draperies & Privacy curtains
 Shadow Box Copperleaf:
 2 pillows
 Shadow Box Palomino:
 1 pillow
 Madison Cream:
 Shower Curtain (28E & 32E)
 Alerts Cream (Viny):
 Berth Bolsters (fore & aft)
 Dinette Seating & Backrest

2007 CABIN INTERIOR COSMIC CARIBBEAN



COSMIC CARIBBEAN - DELUXE
28 & 32 Express Cabin
 Venadium Caribbean:
 V-Berth cushions
 Welt in berth bolsters and dinette seat back
 Cosmic Bic:
 2 Pillows
 Cosmic Lime:
 1 pillows
 Surround Cayman:
 Draperies, Privacy Curtain & 2 Pillows
 Madison Cream:
 Shower Curtain (28-35 Express)
 Alerts Cream (Viny):
 Berth Bolsters (fore & aft)
 Dinette Seating & Backrest

KIOSKE INTERIOR
 20E THRU 35E



KIOSKE/BLUE - BERTH 1



REPLICA/BLUE - BERTH 2



CLAIBORNE/IVORY - DRAPERY (WIDE)



HERITAGE/BEACH - BOLSTERS/DINETTE



DELIA/NAVY - PILLOW (WIDE)



DELIA/BUFF - PILLOW (WIDE)



RHONE/DUNE - PILLOW (WIDE)



RIVERVIEW/LT. GAMED - HEADLINER

MILKY WAY INTERIOR
 20E THRU 35E



MILKY WAY SUNSET - BERTH 1



MILKY WAY SUNSET - BERTH 2



GILMORE/CAFÉ - DRAPERY (WIDE)



HERITAGE/BEACH - BOLSTERS/DINETTE



MILKY WAY/SUNSET - PILLOW (WIDE)



SAHARA CINNAMON - PILLOW (WIDE)



PATINA MULTI - PILLOW (WIDE)



RIVERVIEW/LT. GAMED - HEADLINER

RIDDLE INTERIOR
20E THRU 35E



KIDSKE/BLUE - BERTH 1



PLACID BERRY - BERTH 2



GILMORE/CAFÉ - DRAPERY (WIDE)



HERITAGE/BEACH - BOLSTERS/DINETTE



DIXIE SALSA - PILLOW (WIDE)



DIXIE GINSING - PILLOW (WIDE)



PLACID BERRY - PILLOW (WIDE)



RIVERVIEW/CAMEO - HEADLINER

SURFIN SEAGLASS INTERIOR
29E / 32E / 35E ONLY



SURFIN SEAGLASS - BERTH 1

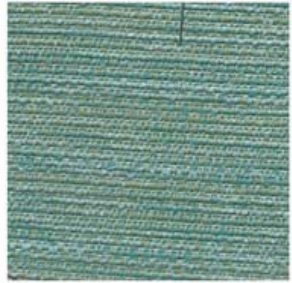

RAFFIA CELADON - BERTH 2



RAFFIA CELADON - DRAPERY



HERITAGE/BEACH - BOLSTERS/DINETTE



RAFFIA CELADON - PILLOW



SOLEIL LAGUNA - PILLOW



INCLINE AQUAMARINE - PILLOW



RIVERVIEW/LT. CAMEO - HEADLINER

Cabinetry

The galley is outfitted with wood grain Formica cabinetry and a matching table. The table can be left in the raised position for dining or lowered to convert the area into sleeping quarters.

To prepare the berth for sleeping, turn the knob on the table leg, push the table all the way down and then tighten the knob to secure the tabletop in position. The 2nd knob on the underside of the tabletop secures the table base to the top. The poly filler piece is then installed on the tabletop and the filler cushion is placed on top of the poly to finish off the berth.

Hard Top with Storage Box (Optional)

The anodized aluminum frame comes with a fiberglass hard top and built in storage box. A set of 4 rod holders is permanently mounted to the aft legs of the frame; providing you with additional rod holder capacity. See the Service and Care section of this manual for cleaning recommendations for the anodized aluminum frame and fiberglass hard top.

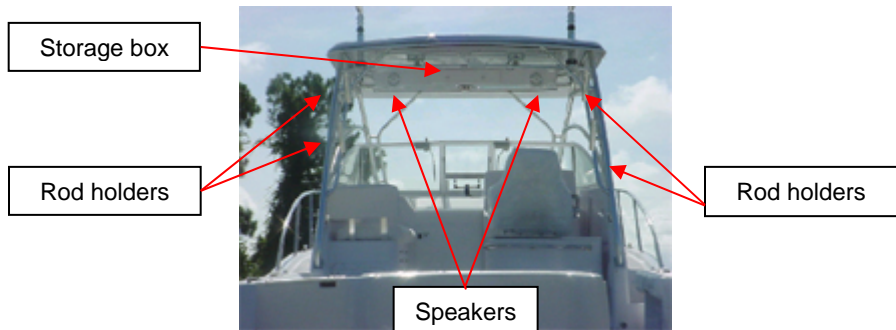

Note: The hard top frame was designed to provide cover for you while you are out on the water and to house the factory installed components. This frame is not intended for standing on while

you are fishing or underway. Modifications to the frame or the improper installation of after market components of a sizeable weight will void the warranty.

Hard Top with Storage Box and Outriggers (Optional)

When factory installed, this options includes the same frame and storage box as above. However, with the installation of the outriggers, we have included mounting pads for additional support.

When this option is selected and factory installed, the outrigger installation includes a pair of outrigger bases, poles and lines. The bases are constructed of anodized aluminum and are installed on the port and starboard sides of the optional T-top. Turn the handle at the bottom of the outrigger base to rotate the outriggers 90 degrees (from the side to the aft end of the boat).

Seating

The following seating comes standard on the 32 Express:

Command seat



Rear facing aft cockpit seat



Tub below the seat drains into the bilge and does not drain overboard.

Lounge seat with bolster



Fold away transom seat



Galvanic Isolator

The galvanic isolator is located behind the starboard panel in the mid berth cabin and above the carbon monoxide detector.

Stray, low voltage current flowing between the AC safety ground and DC bonding system is a principal cause of "galvanic" action. This type of stray current will normally overload your zinc anodes as they try to protect your boat from other near by boats and/or metal objects of the marina. Sacrificial zincs corrode away as they protect metal thru hulls, shafts and props from damaging galvanic corrosion and electrolysis.



Installing the galvanic isolator between the AC safety ground and DC bonding system interrupts the galvanic circuit with other boats and the dock when your boat is plugged into a shore power system. It also maintains an AC safety ground and solves the most common cause of corrosion. Corrosive action on your zincs is significantly

reduced while the integrity of the critical safety ground path is maintained. This means a significant savings in boat haul out fees and zinc replacement costs.

The sacrificial zincs are located on the trim tabs and engines. The zincs should be checked periodically and changed when needed.

Bonding System

All metal components that have water either going through them or touching them are bonded to the zinc anodes on the transom of the boat. The zinc anodes should be checked periodically and changed when needed.

Electronics (Optional)

Based upon the availability from our vendors, this equipment changes from time to time. Therefore, we request that you refer to the owner's manual provided by the manufacturer of your electronics equipment for operational procedures and for information related to the warranty and the care and maintenance of their product. Refer to your owner's package for additional information.

Operation and Performance

Trim / Tilt

The power trim system allows the operator to raise and lower the motor(s) throughout an infinite number of settings between its upper and lower limits. There is a trim setting that will yield maximum speed, stability or maneuverability for every throttle setting. Refer to your engine manual for specific questions regarding the trim and tilt.

For most conditions, the best all-round performance is obtained when the bow of the boat is slightly out of the water and all motors are trimmed to the same degree.

General trim down (or "in") characteristics are:

- Starting position for best acceleration to plane.
- Lowers the bow, which provides better stability and ride in rough water.
- Reduces boat speed and economy due to increased drag of hull and drive.
- More spray over bow.

General trim up (or "out") characteristics are:

- Raises the bow of the boat out of the water resulting in less hull in the water.
- Greater speed and economy for a given throttle setting.
- Greater maneuverability; provided prop does not ventilate during the maneuver.
- In excess, the reduced stability can lead to bouncing, porpoising and propeller ventilation.

In addition to providing ideal boat performance, the power-trim/tilt enables the motors to be raised (tilted up) for trailering, beaching and launching. Avoid operating the trim switch if travel of the motor is blocked or it has reached the limits of travel.

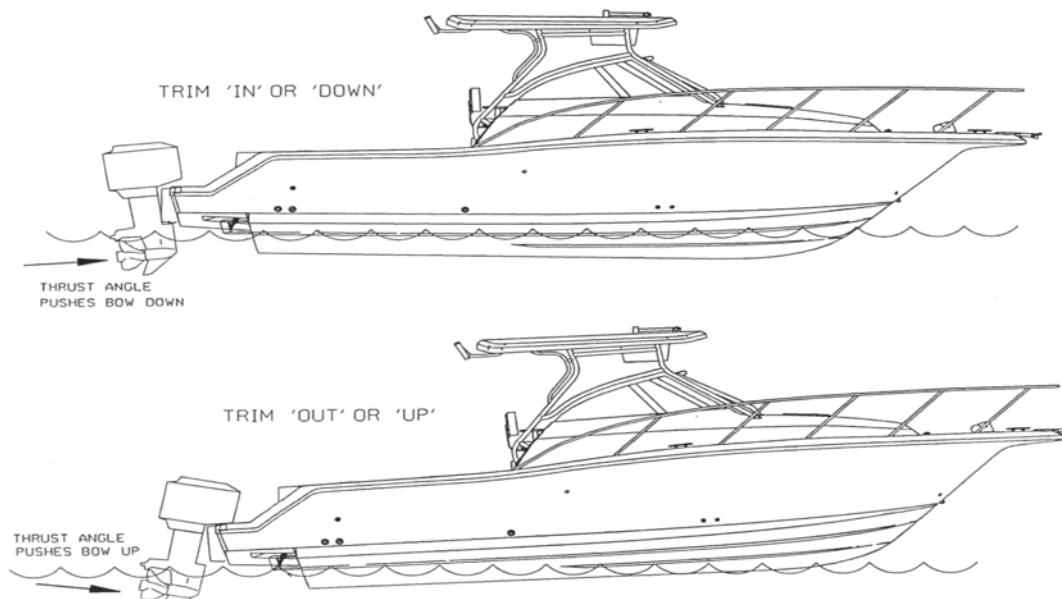

Propellers

If your Pro-Line was ordered with a factory installed engine, it will have a propeller that has been performance tested to provide the best all-round performance for your engine/hull combination at sea level. In some situations,

it may be desirable to re-prop your Pro-Line to enhance the desired performance needs for your area. For instance:

- Decreasing the pitch will enhance acceleration and power at high loads.
- Increasing the pitch will increase speed at light loads.
- Decreasing the diameter will compensate for any loss of power at high altitudes.
- Increasing the diameter results in higher efficiency at low speeds at the expense of top end speed and acceleration.

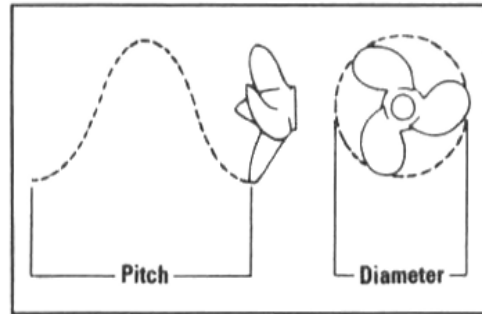

Be sure not to over rev the engine when re-propping or engine damage could result. Operating your engine with a damaged prop will decrease performance, increase fuel consumption, and may introduce undesirable handling characteristics. The vibration caused by running a damaged prop could cause costly damage to your lower drive unit.

Starting

Follow the information in your engine manual if it deviates from the following instructions.

Before Starting the Engines:

- Ventilate all enclosed spaces.
- Visually inspect the bilge for fuel and check for vapors.
- Visually make sure that the propellers are clear of obstructions or swimmers.
- Make sure that the engine cooling water intakes are submerged.
- Lock the helm seat to face straight forward.
- Attach the safety stop switch lanyard.

Starting the Engines:

Start the engine according to the instructions provided in your engine manual.

After Starting the Engines:

After your engine starts, make sure to observe a few basic rules to insure the engine is functioning properly:

- Verify engine cooling water circulation.
- Check the temperature gauge for the first few minutes to make sure the engine is warming properly and not overheating.
- Check for fuel, oil and water leaks. If any leaks are found, shut down the engines and make the necessary repairs before continuing on with your voyage.
- Follow the break-in procedures as recommended by the engine manufacturer for your engines.

Fueling

Certain precautions must be observed when fueling due to the explosive nature of gasoline.

Before Fueling:

- Secure the boat to the dock with adequate moorings.
- Turn off the engine and any equipment having spark-producing contacts.
- Close doors and hatches so fumes do not enter boat.
- Disembark all persons not necessary for the fueling operation.
- Prohibit all smoking and open flames on board and nearby.
- Have a fire extinguisher close by.

While Fueling:

- Keep the nozzle in contact with the fuel fill opening to minimize the possibility of sparks.
- Do not pump fuel into any opening unless it is marked “Fuel” or “Gas”.
- Do not leave the boat unattended.
- Do not spill fuel.
- Do not over fill. Filling a tank until fuel is vented is dangerous.
- Allow room for expansion.

After Fueling:

- Close the fuel fill opening.
- Wipe up any spilled fuel and dispose of the rags on shore.
- Open the doors and hatches to ventilate the boat before starting the engines.
- Check for fumes in the bilge and continue to ventilate if fumes are present.

Loading

The performance of any boat is contingent upon the amount of load carried. Reduce the load to permit safe operation in rough and adverse conditions. Heavy loads reduce the performance and increase fuel consumption. The load positioning greatly affects the performance of your boat. If excessive weight is placed too far aft, the boat may have difficulty getting on plane and may ride rough. If the load is concentrated too far forward, the boat may “bow steer” or veer off to the side when entering a large wave at an angle. There may also be a reduction in the top end speed. The optimum load location is generally near the center of the boat.

When loading your Pro-Line, always:

- Maintain a balance both port to starboard and bow to stern.
- Keep heavy items as low as possible.
- When boarding, step (never jump) into the boat one passenger at a time.
- Pass gear from the dock to someone in the boat. Do not carry gear while boarding.
- Never allow passengers to hang their feet over the side of the boat.
- Do not allow passengers to sit or stand on top of the stern or gunwales.
- Do not overload the boat to the point where water enters the cockpit scuppers.

Service and Care

To enjoy trouble free use of your Pro-Line, follow the recommended procedures and instructions relating to the service and care of your boat. Failure to follow proper maintenance practices will result in shorter life of your equipment and may void your warranty.

Much of the installed equipment on your Pro-Line is warranted separately. Follow the care instructions found in your owner's packet to keep these individual warranties in force.

Your engine manual contains service information relating to your particular engine installation. Follow the engine manufacturer's recommendations for trouble free service and to preserve your warranty rights.

Your new Pro-Line boat is your home away from home. Generally, you should maintain your boat with the same care as you would maintain your home or automobile. Many of the same products used in caring for your home and automobile can be used to maintain your new boat.

Fiberglass and Gelcoat

The gelcoated fiberglass on your Pro-Line provides a smooth, easy to clean and maintain surface. Regular cleaning and waxing will preserve the finish on your boat for many years to come.

Use a mild detergent and plenty of fresh clean water to swab down the exposed gelcoat on your boat. Do not use harsh cleaners containing ammonia, chlorine, or abrasives. Do not use acetone or any ketone solvents. Stubborn stains may be removed with alcohol or kerosene provided they are washed off immediately and completely with a mild detergent and water.

Wax all gelcoat surfaces a minimum of twice a year, more often if the boat is stored in the sun. If neglected, the surface will take on a dull appearance that is not restorable by waxing. Hand buff with a rubbing compound such as Dupont No. 7, or power buff with Mirror Glaze No. 1. Then follow up with a good waxing.

Caution: When power buffing, use care not to leave swirl marks or "burn" the surface. You may want to leave power buffing to a professional.

The gelcoat on your Pro-Line is approximately 25-mil thick. Minor scratches and deep stains that do not penetrate the gelcoat can be lightly wet sanded with 600 grit sand paper, buffed and waxed to remove.

If a deep gouge to the surface occurs that goes through the gelcoat and into the fiberglass, it must be repaired promptly to avoid further damage. Your dealer is best equipped to handle this repair and achieve good bonding and color match. There are many different gelcoat repair kits on the market for this use. However, results obtained may not be satisfactory. See your Pro-Line dealer for fiberglass damage deeper than 1/16 inch.

Epoxy Barrier Coat and Bottom Paint

If your boat will be in the water continuously, we recommend sealing the bottom of the hull with a high quality barrier coating. Unsealed gelcoat may form water blisters. Repair of water osmosis blister damage is not covered under the limited warranty.

The phenomenon of osmotic blistering is known to occur in saltwater, brackish water and/or fresh water. Any boat left in the water for any period of time is susceptible. Nearly all the marine bottom paint manufacturers today offer coatings that help protect the hull against blistering. If required, contact your Pro-Line dealer's Service Department or another qualified service professional for further information.

We recommend that your boat be cleaned often to prevent unwanted marine growth on the hull and to maintain ultimate high performance. The bottom of your boat must be kept clean. Any buildup of marine life from water will create drag and affect the boat's performance and efficiency. Never use brushes or scouring pads on the bottom of your boat, as this can cause small scratches that will actually trap dirt.

Antifouling bottom paint is designed to dissolve slowly to prevent marine growth. Therefore, the hull bottom should be repainted at the beginning of each boating season. Factors to take into consideration when selecting a protective bottom paint are water temperature, pollution, salinity, current and organic material in the water.

Important: Consult your Pro-Line dealer's Service Department or another qualified service professional for recommended bottom paints and local laws that may govern your area. Many states regulate the chemical content of bottom paints to meet environmental standards and regulations.

Blisters are unforeseen and unexplained phenomena that are relatively undefined. There is no 100% method of prevention, although barrier coating and bottom painting are the best known deterrents.

We recommend that a professional apply the epoxy barrier coat and bottom paint. The hull should be sanded prior to applying the barrier coat and bottom paint. This is done so that the epoxy coat will properly adhere to the hull, and when done correctly, will not void the hull warranty. Pro-Line Boats does not recommend using an etching primer in lieu of sanding the bottom.

Bottom painting is an annual operation but may require more frequent applications if the bottom becomes scratched, damaged, etc. We recommend strict adherence to the manufacturer's recommendations when barrier coating and bottom painting your vessel. There is a small window of time in which the coats must be applied in order to properly complete the application process; therefore, we recommend that a qualified professional do this process.

While barrier coating and bottom painting are the best preventative to blisters caused by the environment, this is in no way a guarantee that they will not occur.

Graphics

Your graphics may be cleaned with a mild dish cleaning soap and warm water or a good marine grade cleaner that is recommended for cleaning gelcoat. Never use any harsh chemicals, abrasive cleaners or any hard objects, as they will damage the graphics. Be sure to read the manufacturer's directions carefully before using any product on your graphics or gelcoat.

Gunwale Trim / Rubrail

The gunwale trim/rubrail that is installed at the juncture of the deck and hull is made of flexible, semi-rigid PVC. It should be cleaned with the same products used to clean the gelcoat. The insert is made of stainless steel. See the Stainless Steel section further in this section for cleaning recommendations for the stainless steel insert.

Fuel Water Separators

If fuel water separators are installed on your boat, the "spin on" filter cartridges should be renewed every season at a minimum. Fuel tanks that are not kept full accumulate water faster due to condensation. Therefore, filter cartridges may need to be replaced more often depending upon usage and conditions or if motors begin to run rough. When replacing the filters for the fuel water separators, coat the rubber seal with a film of grease or oil to help prevent sticking.

Water Pumps

The round filter attached to the side of the pumps should be removed and cleaned often with clear water.

Compass

During periods of long storage, it is recommended that you remove the compass from the boat and store it in a location providing normal room temperature. At low temperatures, an air bubble may form on the top of the

dome. This will in no way affect the reading or accuracy. When restored to normal temperature, the air bubble will disappear.

Clean the Lucite compass dome carefully with a moistened soft cloth to avoid scratching. In salt-water operation, salt crystals from the spray may form on the dome. These crystals should be removed with a moistened soft cloth. A dry cloth and/or harsh rubbing may scratch the compass dome. Any good grade of paste wax can be applied to the dome to retain its luster and optical clarity.

Aluminum

Pay particular attention when cleaning the tubing directly beneath the top (hardtop, T-top, Bimini top). This area does not receive the natural rinsing action of rainwater and is shielded from the sun. Therefore, it does not dry as completely or quickly as the rest of the frame. The top of the frame is often overlooked when cleaning the boat and should be hand washed and dried often. This area is likely to be the first place that staining or pitting occurs.

Aluminum is corrosion resistant but not corrosion proof. The grain structure, when modified by welding processes, has increased susceptibility to micro-corrosion (invisible to the unaided eye) and cracking. Proper care will preserve the weld strength and beauty of your aluminum:

- Always clean frequently with a mild non-abrasive soap and lots of fresh water. Most glass cleaners work.
- Always protect with a wax, especially around welds to guard against micro-corrosion, cracking and rust spots.
- Always remove rust and corrosion spots, as they appear, with an aluminum cleaner.
- Thoroughly wash the aluminum with a soft towel or sponge using lots of soap and water. Remove all dried salt crystals and other contaminants. Rinse completely with direct water pressure.
- Clean and rinse it well.
- Wash it often enough to keep contaminants from forming or building up.
- Avoid the use of bleach or chlorides to clean the aluminum and/or nearby components. Chlorides can leach onto the aluminum when nearby.
- Never clean with acids or bleaches.
- Avoid abrasive cleaning products. NEVER use sandpaper, steel wool, brass wool, wire brushes, polishing wheels, or rubbing or polishing compounds. These items will remove anodizing and lead to pitting.
- Never permit contact with iron, carbon steel, or other metals, which could cause rust or corrosion.

Additional information from Taco Metals is included in your owner's package.

Stainless Steel

Stainless steel is used for bow rails and deck fittings on your Pro-Line. Stainless steel is not completely free from corrosion attack. It is NOT stain or rust proof. When used in contact with chloride salts, sulfides or other rusting metals, stainless will discolor, rust or even corrode. The degree of surface oxidation is directly affected by local atmosphere and saltwater concentrations. All metals are subject to corrosion in some environments. The grain structure of stainless, when modified by welding processes, has increased susceptibility to micro-corrosion (invisible to the unaided eye) and cracking.

Our most helpful recommendation is that you give your stainless steel hardware the same attention that you would use to maintain other materials on your boat. Regular fresh-water washing with a mild abrasive cleaner will keep your stainless bright and beautiful.

- Always clean stainless frequently with soap and water. Any cleaner safe for glass is usually safe for stainless
- Always remove rust spots as soon as possible with a stainless, brass, silver or chrome cleaner. Irreversible pitting will develop under rust that remains on stainless for any period of time.

- Always use a cleaner, like a good car wax, for added beauty and protection.
- Never use coarse abrasives like sandpaper or steel wool on stainless as these can cause rusting.
- Never clean with acids or bleaches.
- Never leave stainless in contact with iron, steel or other metals, which cause contamination leading to rust or corrosion.
- Always protect with a wax, especially around welds to guard against micro-corrosion, cracking and rust spots.

Additional information from Romac and G. G. Schmitt and Sons is included in your owner's package.

Corrosion Protection

Spray all electrical connections with a good quality corrosion guard annually and whenever an electrical connection is repaired or replaced.

If you moor your Pro-Line in salt water for extended periods, be sure to check the transom mounted anti-corrosion anode often for operation. Check the electrical connections (green wire) on all metallic fittings with anode for conductivity with an ohmmeter. Make sure the anode surface is exposed and not caked with corrosion and scale. Renew the anode if it is more than 50% eroded. Your motor and/or drive unit have a sacrificial zinc anode to mitigate the effects of electrolysis which causes corrosion. Maintain this anode in accordance with the maintenance schedule in your engine manual.

Cabin / Companionway and Transom Doors

To clean the acrylic door, rinse with fresh water to remove as much grime as possible. Use bare hands with plenty of water so you can feel any grit and avoid grinding it into the surface as you dislodge it. When all material that may scratch the surface is removed, use a soft clean cloth with a non-abrasive mild detergent and fresh water. Rinse and blot dry with a clean dry chamois.

Grease and adhesives may be removed with kerosene, hexane or white gas (not gas you burn in your boat, car, or lawnmower). Never use solvents such as acetone, silicone spray, benzene, carbon tetrachloride, dry cleaning fluid, lacquer or paint thinner, or any chlorinated solvent on acrylic since they may dissolve the material.

Tackle Box

Clean the tackle box trays and storage area using a soft cloth, warm water and a mild detergent.

Windshield

Care Instructions - Regular cleaning with fresh water and a soft cloth will keep and protect your windshield, window or hatch for years.

- Glass - Use commercially available glass cleaners or a mixture of fresh water and vinegar. Do not use abrasives, harsh chemicals or metal scrapers. Regular cleaning will help assure clarity of the glass for safe boating.
- Window Channels - Clean window channels with mild detergent only. Channels can be sprayed with silicon aerosol while sliding the glass back and forth.
- Metal - Polish with commercially available metal polishes. A boat or car wax applied periodically will offer extra protection against the elements.
- Painted Surfaces - Clean with fresh water periodically. Touch up scratches and areas where paint has chipped off with touch-up spray paint. Touch-up kits are available from the windshield manufacturer.
- Boat Top Clips - Never slide boat top clips along windshield framework. To change a clip location, snap on and off the aluminum top track.
- Windshield Vents - Use care when opening and closing vent. Do not force.

- Grounding - Never ground windshield with any electrical devices or appliances.
- Attaching Any Type of Metal Component to the Frame - Whenever attaching *any* metal component to the windshield frame, the windshield manufacturer recommends bedding all metal fasteners in contact with the aluminum frame with Tef-Gel to prevent the possibility of rust, galvanic corrosion, seizing of moving parts, blistering of painted surfaces, etc. between these two dissimilar metals. See the Tef-Gel website (<http://www.wolfwire.com/tefgel/frameset.htm>) for more details.

Windows

The frames of the cabin hatches are made of cast or extruded aluminum. The lenses/windows of all 3 styles of windows (cabin hatches, cabin portholes and mid berth cabin window) are made of Lexan or tough acrylic. Clean the frames and windows with a mild soap, lukewarm water and a soft cloth. Make sure that there is no cross contamination on the cloth. Polish with a mild automobile polish.

Minor scratches on the lens/window can be removed or minimized by using a mild automobile polish such as Johnson's Paste Wax or Mirro Glaze Plastic Polish. Use silicone spray on any moving parts to keep the parts free of salt build up.

Note: Do not clean Lexan or acrylic windows with any window cleaner designed specifically for glass windows or any cleaner containing harsh chemicals such as ammonia or alcohol as this will damage the lens/window.

If needed, replacement parts for the 3 window styles described above (cabin hatches, cabin portholes and the mid berth cabin window) can be obtained from the vendor:

Bomar, A Division of Pompanette
PO Box W, South East Street
Charlestown, NH 03603
603-826-5792 Phone, 603-826-4125 FAX

Curtain Package and Windscreen

Canvas

One of the best ways to keep Sunbrella brand fabrics looking good and to delay the need for deep or vigorous cleanings is to hose fabrics off on a monthly basis with clear water. This practice will help prevent dirt from becoming deeply imbedded in the fabric and eliminate the need for more frequent vigorous cleanings. In most environments, a thorough cleaning will be needed every two to three years. When it's time for a thorough cleaning, Sunbrella fabrics can be cleaned while still installed on your boat. It is important to observe the following:

- Brush off loose dirt.
- Hose down.
- Prepare a cleaning mixture of water and mild soap (Ivory Snow, Dreft or Woolite - no detergents). Water should be cold to lukewarm. Never more than 100 degrees.
- Use a soft bristle brush to clean.
- Allow soap to soak in.
- Rinse thoroughly.
- Air dry. Never apply heat to Sunbrella fabrics.

If stubborn stains persist, you can use a *diluted chlorine bleach/soap mixture* for spot cleaning of mildew, roof run-off or other similar stains. Prepare a special cleaning mixture:

- Four ounces (half cup) of chlorine bleach.
- Two ounces (one-fourth cup) of mild soap.
- One gallon of water.

- Clean with soft bristle brush.
- Allow mixture to soak for up to 20 minutes.
- Rinse thoroughly.
- Air dry.
- Repeat if necessary.

Re-treating the Fabric - Sunbrella fabrics are treated with a fluorocarbon finish to enhance water repellency. This finish is designed to last for several years, but must be replenished after a thorough cleaning. Based on test results, Glen Raven recommends [303 High Tech Fabric Guard™](#) as the preferred re-treatment product for Sunbrella fabrics. Fabrics should be retreated after thorough cleaning or after five years of use. Check with your local Sunbrella dealer or distributor for additional information.

For more information, visit the Sunbrella website at www.sunbrella.com for specific recommendations.

Isinglass (Windscreen Material)

Maintenance means "rinsing" with cold water and trying not to rub the dirt into the Isinglass. Never "Dry" dust the Isinglass panels. Any rubbing acts like sandpaper to plastic so keep rubbing to a minimum. Always use lots of cold water and a very very soft cloth when rubbing is required. Do not use paper towels or Terri-cloth towels. Try not to use any cleaning solutions, as most will cause yellowing and cracking.

When you have to store the panels of your windscreen and curtain package, always "roll up" the material to prevent *creases*. Do not fold the Isinglass as this will permanently damage the Isinglass material. Do not roll up the panels when wet, as the material will turn white or fog up. Dry the panels off first using a very very soft cloth before rolling them up. A few hours in the sun will get rid of the whiteness or fogginess in most cases.

Vinyl

Interior Vinyl - Cabin Headliner and Cabin Bolsters

Clean periodically to maintain the appearance of the vinyl and to prevent the build-up of dirt and contaminants. Any stain, spill or soiling should be cleaned promptly to prevent the possibility of permanent staining. When cleaning, always scrub gently using a soft cloth or nylon bristle brush.

Caution: Powered abrasives, abrasive cleaners and steel wool will damage vinyl, as do strong solvents, lacquer solutions and inks. Lotions, suntan oil, waxes and polishes, etc., contain oils and dyes that can cause stiffening and staining of the vinyl. Never use steam, heat guns or hair dryers.

For additional information regarding the care and maintenance of this product, please refer to the Morbern brochure provided in your owner's package for recommended methods to clean specific types of stains.

Exterior Vinyl – Upholstered Seats and Cockpit Bolsters

Vinyl requires periodic cleaning to maintain its neat appearance and to prevent the build-up of dirt and contaminants that may permanently stain and reduce the life of the vinyl if they are not removed. The frequency of cleaning depends on the amount of use and on environmental conditions to which the vinyl is subjected. The procedures used for cleaning are dependent upon the end use circumstances.

For normal cleaning, most stains can be cleaned using warm soapy water and a clear water rinse. Moderate scrubbing with a medium bristle brush will help to loosen soiling material from the depressions of embossed surfaces. For stubborn stains, use either Fantastic or Mr. Clean, which are commercially available mild detergents, in accordance with manufacturers instructions.

For additional information regarding the care and maintenance of this product, please refer to the Morbern brochure provided in your owner's package for recommended methods to clean specific types of stains.

Cloth

Cabin Cushions, Pillows and Curtains

The manufacturer of the materials used in making the cabin cushions, pillows and curtains recommends the following cleaning procedures:

Spot clean only with water based shampoo or foam upholstery cleaner. Pretest a small, inconspicuous area before proceeding. Do not over wet. Do not use solvents to spot clean. Pile fabrics may require brushing with a non-metallic, stiff bristle brush to restore appearance.

Note: Water extraction or steam cleaning is not a recommended cleaning method. Cushion covers should not be removed and laundered. To prevent overall soiling, frequent vacuuming or light brushing with a non-metallic, stiff bristle brush to remove dust and grime is recommended. When cleaning a spill, blot immediately to remove spilled material. Clean spot stains from the outside to the middle of the affected area to prevent circling.

Use a professional furniture cleaning service when an overall soiled condition has been reached.

For additional information regarding the care and maintenance of this product, please refer to the Morbern brochure provided in your owner's package for recommended methods to clean specific types of stains.

Countertops and Sinks

Galley Countertop

Your Corian® countertop has a matte/satin finish. Over time, routine cleaning may raise the gloss level of the countertop. Soapy water, ammonia-based cleaners (not window cleaners) or commercially available solid surface cleaners will remove most dirt and residue from all types of finishes. Stubborn residue will require a little stronger cleaner. Follow the recommendations below to properly clean your countertop.

Over time, through care and use, your countertop will acquire a patina, changing the appearance of the finish. You may restore the look of the original finish by following the refurbishing guidelines on the Corian® website.

- Most dirt and residue – Use soapy water or an ammonia based cleaner (not window cleaners), rinse and wipe dry.
- Preventing hard water marks – Wipe countertop dry after spills or cleaning.
- Removing hard water marks – Use an over-the-counter cleaner formulated for hard water marks.
- Difficult residue – Spray the residue with Deep Cleaner for DuPont Corian® from Stone Care International. Follow the instructions on the cleaner bottle. Wash the area with soapy water, rinse the area with clean water and wipe dry. If the residue persists, repeat the process. If the residue still persists, follow the directions for removing scratches.
- Disinfecting – Occasionally, wipe the surface with diluted household bleach (1 part water/1 part bleach).
- Preventing Damage
 - Heat Damage – Corian® is an excellent material for heat resistance. As with all countertop materials, it is important to minimize direct exposure to protect your surface and investment. Always use heat trivets or hot pads when placing hot objects on any surface. Allow cookware to cool before placing them on a Corian® countertop.
 - Other damage – In most cases, Corian® can be repaired if accidentally damaged. However, be sure to follow the guidelines here to prevent any permanent damage to Corian®.
- Avoid exposing Corian® to strong chemicals, such as paint removers, oven cleaners, etc. If contact occurs, quickly flush the surface with water.
- Do *not* cut directly on Corian® countertops.
- Removing minor cuts and scratches – Because the solid beauty of Corian® goes all the way through, Corian® surfaces are completely renewable. You can remove minor cuts and scratches yourself by following these instructions.

- First, wash the area to remove any film that may clog the pads. Start with the Green pad. (Pad color from roughest to smoothest is: White, Yellow, Green, Peach, Lilac, Blue, Gray.) Rub over scratch in a straight line to remove it. Periodically switch rubbing direction 90 degrees. Be sure all of the scratch is removed. If this first step takes too long, try the Yellow pad. To minimize dust during sanding, wet the surface. Rinse pad periodically to clean residue.
- Clean top with water. Inspect to see if scratch was removed. If scratch remains repeat previous step. If scratch is gone, select next finer grit and repeat process. Rub over a larger area to blend in sanding.
- Continue process using successively finer grits until the area blends closely with the surrounding surface gloss. Wash area to remove all sanding dust and residue. Rinse with clean water and wipe dry.

Note: Refer to sources for materials below to obtain the abrasive pads and other products mentioned above:

- | | |
|-----------------------------------|---|
| • Abrasive Pads | Micro-Surface Finishing Products, Inc. @ 800 225-3006 |
| • Countertop Magic® | Magic America Corp. @ 800-321-6330 |
| • Clean EnCounters® | SCI @ 800-839-1654 or The Home Depot |
| • Deep Cleaner for DuPont Corian® | SCI @ 800-839-1654 or The Home Depot |
| • Enhance Countertop Polish | EMS @ 800-643-8818 |
| • Green Scotch Brite® | Local Supermarket or hardware stores |
| • Hope's Countertop Polish | The Hope Co. @ 800-325-4026 |
| • SoftScrub® | Local supermarket |

For additional information log onto the manufacturer's website at www.corian.com.

Galley Sink

Preventing Damage – In most cases, Staron® can be repaired with ease if accidentally damaged. However, be sure to follow these guidelines to prevent any damage to Staron®.

- Heat damage - Even though Staron® Solid Surfaces have excellent heat resistant property compared with other ordinary countertops. However, placing hot pans, as well as some heat-generating appliances such as frying pans or pots can damage the surface. Always use a hot pad or a trivet with rubber feet to protect Staron®. Avoid long-term exposure of Staron® to temperatures over 170 degrees F (80 degrees C).
- Other Damage - Avoid exposing Staron® Solid Surfaces to strong chemicals such as paint removers and oven cleaners. Surfaces exposed to these chemicals should be promptly flushed with water. Prolonged contact will cause spots and require extensive repairs. Do not cut directly on a Staron® Solid Surfaces surface; always use a cutting board.
- Run cold water when pouring boiling water into sinks.
- Remove nail polish with a non-acetone based nail polish remover and flush with water.

For more information log onto the manufacturer's website at www.staron.com

NOTE: Any of the above can affect the surface finish and color. Dark colors may require more maintenance. Staron®'s solid composition makes it easy to maintain because it is homogenous. The surface can be restored to its original sheen by removing stains and scratches with a detergent. Periodic maintenance is recommended to retain the surface quality and appearance.

Routine Cleaning – Occasionally clean the surface with soap, water and an ammonia-based cleanser using a sponge or damp cloth. Towel dry.

To remove severe and difficult stains

- Dull finish: Use an abrasive cleanser and a green Scotch-Brite® pad. Rub in a circular motion.
- Semi-gloss finish: Use Soft Scrub® cleanser, diluted with bleach and a white Scotch-Brite® pad. Rub in a circular motion.

- High-gloss finish: Follow the procedure for semi-gloss, but use a sponge instead of a Scotch-Brite® pad, or use a white polishing compound in a circular motion.

Contaminants that can be cleaned with water

- | | | |
|----------------------|-----------------------|------------------------|
| • Alkaline Solutions | • Milk | • Synthetic detergents |
| • Coffee | • Nail polish remover | • Tea |
| • Fruit juice | • Olive Oil | • Vinegar |
| • Household soap | • Shoe polish | • Water-soluble ink |
| • Hydrogen peroxide | • Soy sauce | • |

Contaminants that can be cleaned with a household cleaner:

- | | | |
|--------------|-------------------|------------------|
| • Cosmetics | • Hair dye | • Ketchup |
| • Crayon | • Iodine solution | • Oleaginous ink |
| • Eye shadow | | |

Substances that can damage the surface of Staron® include industrial chemicals such as:

- | | | |
|----------------|-----------|-----------------------|
| • Strong acids | • Ketones | • Solvenated chlorine |
|----------------|-----------|-----------------------|

Disinfecting Surfaces and Sinks – Wipe occasionally with diluted household bleach (water:bleach solution in 1:1 ratio).

Removing Cuts and Scratches – When Staron® Solid Surfaces are scratched or cut, repairs should be based on one of the following recommendations. Staron® Solid Surfaces highly recommend that extensive repairs should be preformed by Certified Staron® Solid Surfaces fabricators.

- Dull finish: Sand with 180 grit (120 micron) or 220 grit (60 micron) fine sandpaper until the cut and scratch is removed. Restore finish with soap and water, and a green Scotch Brite® pad to match the finish of the adjacent surface.
- Semi-gloss finish: Sand with 400 grit (30 micron) sandpaper, and restore finish with a nonabrasive cleanser and a white Scotch-Brite® pad.
- High gloss finish: Sand with 400 grit (30 micron) or 600 grit (20 micron) sandpaper, and buff with a polishing compound and a low speed (1500 – 2000 rpm) polisher using a wool pad. Finish with was.

All of the above sanding and polishing should be done in a circular motion.

Formica

Clean the tabletop and cabinets with warm soapy water and/or a good quality Formica cleaner available at Home Depot, Lowes, etc. Maintain it just as you would care for any Formica counter.

Appliances

Refrigerator

Do not use abrasive cleaning agents or hard objects during cleaning as these can damage the refrigerator. Never use hard or pointed tools to remove ice or to loosen objects, which have frozen in place. As soon as the refrigerator becomes dirty, clean it with a damp cloth. Wipe the refrigerator with a dry cloth after cleaning. Make sure that no water drips into or through the sealing while cleaning as this can damage the electronics.

Microwave

Keep the inside of the oven clean. When spilled liquids or food splatters adhere to the oven walls, wipe the walls clean with a damp cloth. Mild detergent may be used if the oven gets very dirty. Avoid the use of spray and other harsh cleaners and they may stain, streak or dull the door surface. The outside surfaces should be cleaned with a damp cloth. To prevent damage to the operating parts inside the oven, water should not be allowed to seep into the ventilation openings. The glass tray may be cleaned with warm sudsy water or in a dishwasher.

Stove

The outside of the stove can be wiped clean with a mild solution of dishwashing detergent and warm water. Avoid abrasive cleaners or cleaning pads. Dry thoroughly before use.

Removable grate/drip pan is dishwasher safe. Use gentle scrubbing with a dry bristle brush when cleaning the burner head. Make sure all gas openings are free of obstructions.

Flooring

Laminated Wood Grain Flooring

Pick up loose dirt with a vacuum cleaner or Dust Buster and wipe up spilled materials with a clean damp cloth. For normal cleaning, use only a mild dishwashing soap (i.e., Dawn, Ivory, etc.), warm water and a soft cloth. For stubborn stains, please refer to the material in your Owner's Package that was provided by the manufacturer of the laminated flooring.

Teak and Holly

The optional Teak and Holly flooring is covered with a lacquer finish. Pick up loose dirt with a vacuum cleaner or Dust Buster and wipe up spilled materials with a clean damp cloth. For stubborn stains, you may use household products such as Old English Furniture Polish, Liquid Gold, Pledge, Endust, etc. These products are all commercially available at most grocery stores, Home Depot, Lowes, etc.

Winterizing and Storage

Your new Pro-Line was winterized before it left the factory. If you launch the boat prior to storing it for the winter, please complete and/or comply with the following check list in order to ensure an easy "fitting out" in the spring:

Pre-Storage Check List:

- Remove drain plugs, keeping the bow high to drain any water accumulation.
- Run a pint of RV antifreeze through the bilge pump.
- Drain all water systems, including the head, and pump an approved antifreeze through all pumps, valves, drains and lines.
- Fill fuel tank (3/4 – 7/8 full) and add a stabilizer/conditioner such as "STA-BIL" to the gasoline.
- Prepare engine in accordance with the engine manufacturer's recommendations found in your engine manual.
- Treat metal parts with a rust inhibitor.
- To prevent mold and mildew, use an absorbing product such as DampRid according to the manufacturer's directions. An alternative and inexpensive option is to fill egg cartons with charcoal briquettes that have not been pre-treated with lighter fluid.
- Remove batteries and protect them from freezing. Trickle charge overnight once a month.
- Place under cover. If the boat is stored on a trailer, loosen tie-down straps and place blocks beneath axles to relieve the load on the tires.

For inboard/outboard engines only, to protect your boat during transport, the following procedures were affected at the factory prior to shipping and will need to be rectified prior to launch:

- Drain plugs on engine block removed.
- Petcocks on engine removed.
- Large hose on re-circulating pump removed.
- Power steering cooler hose removed.
- All other water hoses disconnected (left in place with hose clamps tightened to prevent their loss).

Fitting Out After Storage

- Check entire fuel system for loose fittings, leaks and damage.
- Clean battery terminals; install battery(s), and coat terminals with a deoxidizing agent.

- Check all thru hull fittings and hoses for obstructions, water tightness and condition.
- Test all lights for proper operation.
- Check wiring, terminal blocks and plugs for loose connections and corrosion.
- Verify switch and equipment operation.
- Check line condition. Inspect anchor and rope.
- Clean out any debris from bilge and cockpit.
- Flush water systems.
- Install hull drain plug.
- Verify operation of equipment before leaving dock.

Resealing

In the heat and sun, silicone and sealant can degrade over time. We recommend that you reseal around everything that comes in contact with the deck or hull with a high quality silicone such as 3M 5200 sealant annually. This includes but is not limited to the following:

- | | | |
|------------------------------------|--------------------------|---------------|
| • Hard top stanchions and supports | • Hatches on the top cap | • Windshield |
| • Clam shell at the anchor locker | • Thru hull fittings | • Port lights |
| • Access and other hatches | • Motor mounts | • Grab rails |
| • Bow and transom eyes | • Cabin door | • Windlass |
| • Bow rail stanchions | • Dive ladder | • Rubrail |
| • Mid berth cabin window | • Outriggers | • Cleats |

Additional Cleaning and Maintenance Products

Flitz - For use on brass, copper, stainless steel, chrome, silver, gold, pewter, nickel, factory gun bluing, bonze, platinum, tin, aluminum, magnesium, anodized aluminum, painted surfaces, fiberglass, Plexiglas and plastics. Flitz is available at many marine supply stores, marinas and at Home Depot. For more information on this product, contact the manufacturer at:

Flitz International Ltd., Waterford, WI 53185, 800-558-8611

Woody Wax - Can be used on a variety of surfaces such as:

- Aluminum and Metals – T-tops, tuna towers, anodized aluminum, aluminum, stainless, chrome, boat trailers, fishing gear, etc.
- Fiberglass and Non-Skid – Fiberglass, non-skid decks and colored gelcoat.
- Electrical and Engines – Electrical equipment, electrical connections, wiring harnesses, outboards, engines.
- Plastics – Plastic, vinyl seats, Plexiglas.

Be sure to read the manufacturer's information carefully before using Woody Wax products on any component on your boat. For more information regarding this product, visit their website at www.woody-wax.com.

Tef-Gel - The windshield manufacturer recommends bedding all SS fasteners that come in contact with aluminum with Tef-Gel to prevent the galvanic corrosion between these two dissimilar metals. See the Tef-Gel website for more details (<http://www.wolfwire.com/tefgel/frameset.htm>).

Ivory Soap and clean warm water – no cross contamination

Lysol Foaming Cleaner - Works well for cleaning gelcoat, vinyl and Formica.

Appendix

Helpful Check Lists

Print and use these checklists, and do not operate your boat without doing the following:

Each Time You Go On a Boat Trip

- Make sure you know where CO exhaust outlets are located on your vessel.
- Educate all passengers about the symptoms of CO poisoning and where CO may accumulate.
- When docked or rafted with another boat, be aware of exhaust emissions from the other boat.
- Confirm that water flows from the exhaust outlets when the engines and generator are started.
- Listen for any change in exhaust sound that could indicate an exhaust component failure.
- Test the operation of each CO alarm by pressing the test button.

Once a Month

- Make sure all exhaust clamps are in place and secure.
- Look for exhaust leaking from exhaust system components. Signs include rust and/or black streaking, water leaks, or corroded or cracked fittings.
- Inspect rubber exhaust hoses for burned, cracked or deteriorated sections. All rubber hoses should be pliable and free of kinks.
- Clean the bilge and all bilge components with a mixture of bleach and water. Then, follow up by misting the bilge and components with WD-40. This includes but is not limited to the hoses, seacocks, pumps, connections, clamps, air conditioner pumps, generator, etc.

Once a Year

Have a qualified marine technician:

- Replace exhaust hoses if cracking, charring or deterioration is found.
- Ensure that your engines, generator and air conditioner are properly tuned and well maintained.
- Inspect each water pump impeller and the water pump housing. Replace if worn. Make sure cooling systems are in working condition.
- Inspect all metallic exhaust components for cracking, rusting, leaking or loosening. Be sure to check the cylinder head, exhaust manifold, water injection elbow and the threaded adapter nipple between the manifold and the elbow.
- Clean, inspect and confirm proper operation of the generator cooling water anti-siphon valve (if equipped).
- Spray CRC on all of the connections behind the console.

Boat Identification Information

Owner: _____

Home Port: _____

Dealer: _____

Boat Name: _____

Registration Number: _____

Hull ID Number: _____

Boat Model: _____ LOA: _____ Beam: _____ Draft: _____

Vertical Clearance: _____ Hull: _____ Deck: _____ Interior: _____

Warranty Registration Date: _____

Fuel Capacity (Gallons): _____

Ignition Key #: _____

Cabin/Head Door Key #: _____ Other Key #: _____

Radio Call Letters: _____ Bat.: _____

Engine Make: _____ Model: _____ HP: _____

Port Engine S/N: _____ Port Drive S/N: _____

Center Engine S/N: _____ Center Drive S/N: _____

Stbd Engine S/N: _____ Stbd Drive S/N: _____

Prop: Diam: _____ Pitch: _____ P/N: _____

Trailer Make & Model: _____

Trailer S/N: _____ GVWR: _____

Insurance Company: _____

Agent: _____

Policy #: _____ Phone #: _____

Trouble Shooting Chart

PROBLEM:	POSSIBLE CAUSE
Poor speed or fuel economy:	Wrong propeller for load or conditions. Trim is in too far. Load is too far forward or too heavy. Boat has taken on water. Marine growth on hull. Line or anchor is dragging. Fuel is stale or partially blocked. Engine is worn, out of tune or underpowered. Improper rigging. Air intake or exhaust is partially blocked.
Engine cranks but will not start:	Out of fuel. Filter is clogged. Fuel line kinked or fuel vent plugged. Water in fuel. Engine problem (electrical, fuel pump, blockage, etc.). Safety stop switch lanyard not installed.
Engine will not crank:	Drive is in gear (check operation of the throttle release). Battery is weak. Terminals corroded or loose. Engine or drive is damaged.
Engine runs but boat will not go:	Throttle release is engaged. Disconnected shift linkage. Damaged prop, or lower drive unit. Entangled in lines or weeds. Anchor is down.
Prop cavitates:	Trim out too far. Motor is too high. Weeds on prop. Bow heavy, damage to hull. Prop is damaged.
Excessive vibration:	Propeller, engine, or drive unit damaged. Hull damaged.
Boat will not turn:	Steering unit needs fluid or has trapped air. Tiller is disconnected (helm turns). Steering trunion or mechanism jammed (helm won't turn).
Electrical problems:	Corroded wires, terminals or plugs. Broken, loose or short circuited wires. Circuit breaker tripped. Defective switch, device or breaker. In-line fuse blown. Overloaded circuit.
Handling problems like:	
Porpoises	Trimmed out too far, damaged hull (rocker), trim tabs up, stern heavy.
Runs wet	Trimmed in too far, bow heavy, trim tabs down, overloaded for conditions.
Hard ride	Stern heavy, trimmed out too far, going too fast for conditions.
Lists	Loaded to one side, trim tabs set wrong, trimmed too far in, fuel tanks uneven.
Over bank in turn	Trimmed in too far, improperly located load, throttle advanced too far.
Catches in turns	Damaged hull (hook), stern heavy, trim tabs down.